

MAIN CATALOG



Dear Customer, Welcome to Momento



Torbjörn Palmberg
President AB Momento

Kära läsare, i din hand håller du vår senaste katalog

Momentos resa började redan 1951 här i Sverige, med ett mål: att tillverka krafthylsor och tillbehör. Det gör vi än idag. Vi är en av få tillverkare som har kunskap i huset inom materiallära och värmebehandling. Vi har ett komplett labb där vi kan mäta allt som går att mäta inom värmebehandling. Vi har även ett testrum där vi kan kontrollera brott, utmattning och slitage på våra egna och konkurrenternas produkter.

Därutöver designar vi kundanpassade verktyg, vilket framförallt fordonsindustrin har utnyttjat. Vi gör alla steg från produktutveckling, design, tillverkning, test av verktyget till leverans av färdig produkt. Allt för att möta era specifika behov. Silverline™, vår ytbehandling, är helt fri från tungmetaller. Detta är viktigt för oss då vi värnar om både miljön och operatören som ska använda verktyget.

Vi har en lång referenslista över kunder inom fordonsindustrin, olja och gas, gruvindustrin, varv, vindkraft samt tyngre industri, vilka har insett fördelarna med att använda våra produkter – de spar både tid och pengar.

Sist men absolut inte minst är det med enorm stolthet vi kan garantera dig att du inte lär hitta någon krafthylsa som varken har bättre egenskaper eller livslängd än en hylsa från Momento.

Om du har några frågor om oss eller våra produkter kan du vända dig direkt till oss eller ta kontakt med någon av våra återförsäljare runt om i världen.

Vi och våra återförsäljare hjälper dig gärna att hitta den bästa lösningen för just dig och ditt företag!



Dear reader, in your hand you hold our latest catalog

Momento's journey began way back in 1951 in Sweden, with one purpose: to manufacture impact sockets and accessories. We continue to do it till date. We are one of the few manufacturers who have in-house knowledge regarding materials and heat treatment.

We have a complete lab where we can measure everything that can be measured regarding heat treatment. We also have testing facilities where we can test both our and competitors products until breakage, fatigue and wear occur.

In addition, we design customized tools, which have been used primarily by the automotive industry. We "have complete value chain" from product development, design, manufacturing, testing of the tool to delivery of finished product. Everything to meet your specific needs.

Silverline™, our surface treatment, is completely free of heavy metals. This is important for us as we protect both the environment and the operator who will use the tool.

We have a long reference list of customers in the automotive industry, oil and gas, mining industry, shipyards, wind power and heavy industry, who have realized the benefits of using our products - they save both time and money.

Last but certainly not least, it is with immense pride we can guarantee you that you will not find any impact socket that has better properties or longevity than a socket from Momento.

If you have any questions about us or our products, please contact us directly or contact one of our distributors around the world.

We and our distributors are happy to help you find the best solution for you and your company!



Sehr geehrte Leserin, sehr geehrter Leser, Sie halten jetzt unseren aktuellen Produktkatalog in Händen

Momento's Reise beginnt im Jahr 1951 in Schweden, mit einem klaren Ziel: Herstellung von Kraftsteckschlüsseln und das dazugehörige Zubehör. Diesem Ziel folgen wir bis heute! Momento ist einer der wenigen Hersteller weltweit, die Fachleute im Bereich der Materialbearbeitung und Härtetechnik im Hause haben.

Darüber hinaus haben wir ein komplettes Prüflabor, das uns ermöglicht, alles zu messen, was im Bereich von Wärmebehandlung messbar ist. Zusätzlich haben wir mit unserem Prüfraum die Möglichkeit, alle Produkte auf Bruch, Ermüdung und Verschleiß zu prüfen.

Momento ist in der Lage Sonderlösungen in allen Abmessungen und Varianten anzubieten, was vor allem von der Fahrzeugindustrie gerne genutzt wird. Wir bieten Ihnen ein Rundum-sorglos-Paket: Beginnend bei der Produktentwicklung, dem Design und der Herstellung, bis hin zum Test der Werkzeuge, unterstützen wir Sie bei allen offenen Fragen. Wir können Ihnen garantieren, dass die Herstellung seit 1951 nur in Schweden erfolgt.

Silverline™, unsere Oberfläche ist völlig frei von Schwermetallen. Momento geht als gutes Vorbild voran! Wir möchten unsere Umwelt und auch den Anwender beim Anwenden unserer Produkte schützen!

Momento verfügt über eine lange Referenzliste von Kunden der Fahrzeug-, Gas-, Bergbau-, Schiffsbau-, Windkraft- sowie der Schwerindustrie. Unsere Kunden schätzen die Vorteile unserer Produkte, weil sie durch die Anwendung unserer Produkte sowohl Zeit als auch Geld sparen.

Zu guter Letzt garantieren wir Ihnen mit großem Stolz, dass Sie keinen Kraftsteckschlüssel finden werden, der bessere Eigenschaften und eine längere Lebensdauer als ein Steckschlüssel von Momento aufweist.

Bei Fragen zu unserem Unternehmen oder Produkten wenden Sie sich bitte direkt an uns oder an unsere Vertragshändler weltweit.

Wir helfen Ihnen gerne, die beste Lösung für Sie und Ihr Unternehmen zu finden.



 **momento**

MADE IN SWEDEN SINCE 1951



HOW IT ALL STARTED



När Momento startade 1951 var målsättningen klar: Vi ska göra krafthylsor. Och det har vi fortsatt med.

Den enda fabriken i världen som bara tillverkar krafthylsor och tillbehör ligger i Flen, Sverige. Där finns Momento - där finns specialisterna.

Hela tillverkningsprocessen äger rum under ett tak; från kapning av stång-materialet till härdning och yt-behandling av den färdiga produkten.

Vi kontrollerar hela tillverkningsprocessen från konstruktion och hållfasthetsberäkning till värme-behandling.

Core Drive i nyckelgrepp och fyrkant ökar styrkan hos Momentos krafthylsor.

Rätt använda går Momento krafthylsor och tillbehör inte sönder.

Rapportera fel i utförande och material så blir verktyget utbytt.



Momento started in 1951 with one clear objective - to manufacture impact sockets. And we have continued as we began.

The only factory in the world exclusively manufacturing impact sockets and accessories is located in Flen, Sweden. That's where you'll find Momento - that's where you'll find the experts.

The whole manufacturing process takes place under one roof; from the cutting of the steel rods to hardening and surface treatment.

We control the entire manufacturing process from design and calculation of strength to heat treatment.

6- and 4-point with Core Drive enhances the strength of Momento sockets.

Correctly used Momento machine-operated sockets and accessories do not break.

Report defects in workmanship and materials and the tool will be replaced.



Als Momento 1951 begann, war die Zielsetzung klar - die Herstellung von Kraftsteck-schlüsseln. Und das hat sich bis heute nicht geändert.

Das einzige Unternehmen der Welt, das ausschliesslich Kraftsteckschlüssel und Zubehör erzeugt, hat seinen Standort in Flen, Schweden. Dort ist Momento zu Hause - dort sind die Spezialisten.

Der ganze Herstellungsvorgang findet unter einem Dach statt; von dem Sägen der Stahlstangen bis zur Härtung und Oberflächenbehandlung.

Momento kontrolliert den ganzen Herstellungsvorgang ab Konstruktion und Berechnung der Festigkeit bis zu Wärmebehandlung.

Das Core Drive Profil in 6- und 4-Kant erhöht die Stabilität der Momento Kraft-Steckschlüssel-Einsätze.

Korrekt eingesetzte Momento maschinenbetätigte Steckschlüsseleinsätze und Zubehör gehen nicht kaputt.

Melden Sie Herstellung oder Materialfehler, damit das Werkzeug ausgetauscht werden kann.



©momento®
MADE IN SWEDEN

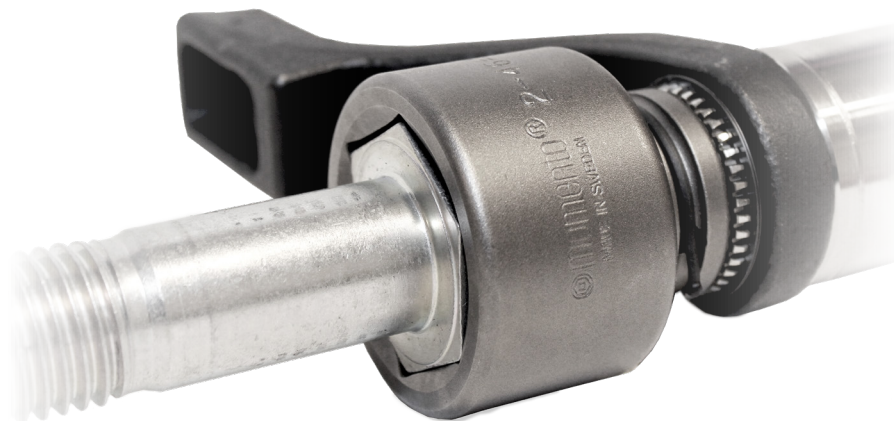

WE ARE THE IMPORTANT LINK



Vi ser som vår uppgift att fylla luckan mellan mutterdragaren och skruvförbandet. Allt som kan komma att behövas där ska Momento kunna tillhandahålla.

Den här katalogen täcker de mest efterfrågade produkterna.

Vi konstruerar och tillverkar specialverktyg för varje enskild kunds särskilda önskemål.

Krafthylsor och tillbehör är den viktiga länken mellan mutterdragaren och skruvförbandet.

För maskinell skruv- och mutterdragning är kraftverktyg det enda rätta.

Våra krafthylsor och tillbehör passar både för segdragande och slående mutterdragare.

Momentos krafthylsor motsvarar de internationella standarderna ISO 691, 1174-2, 1711-2, 2725-2 och 2725-3.

Momento är kvalitetscertifierat enligt ISO 9001 och miljöcertifierat enligt ISO14001.



Momento see their mission as that of filling the gap between the power tool and the threaded fastener and of supplying anything that you might need for this purpose.

This catalog covers the items that are most in demand.

Momento design and produce special tools to meet the individual requirements of every single customer. Power sockets and accessories are the all-important link between the power tool and the threaded fastener.

When it comes to power driving tools, power sockets are the only answer

Momento's power sockets and accessories will fit both impact wrenches, electric nutrunners and hydraulic wrenches.

Momento's impact sockets and accessories conform to the international standards ISO 691, 1174-2, 1711-2, 2725-2 and 2725-3.

Momento are ISO 9001 quality certified and ISO 14001 certified for their environmental management system.



Momento hat sich zur Aufgabe gestellt, die Lücke zwischen Schrauber und Schraubverbindung zu füllen. Alles, was hierfür benötigt werden kann, wird von Momento angeboten. In diesem Katalog sind die am meisten gefragten Produkte enthalten.

Spezialwerkzeuge werden nach den speziellen Wünschen jedes einzelnen Kunden konstruiert und hergestellt.

Kraftsteckschlüsseleinsätze und Zubehör sind das wichtige Verbindungsglied zwischen Schrauber und Schraubverbindung.

Für das maschinelle Schrauben sind nur Kraftsteck-Werkzeuge geeignet.

Momento Kraftsteckschlüssel und Zubehör können sowohl für Impulsschrauber als auch für Schlag-schrauber verwendet werden.

Momento Kraftsteckschlüssel und Zubehöre stimmen mit den internationalen Standards ISO 691, 1174-2, 1711-2, 2725-2 und 2725-3 überein. Die Firma Momento hat Zertifizierungen nach ISO 9001 und ISO 14001 erhalten.

CUSTOM
MADE
PRODUCTS



ECO
FRIENDLY

DISTRIBUTORS
AROUND
THE WORLD



SCAN
THIS AND
WATCH

Vi bryr oss om miljön

Som en del av en långsiktig miljöstrategi är Momento det första företaget i världen som framgångsrikt har utvecklat en beläggning utan att använda några tungmetaller i ytbehandlingsprocessen.

Den nya beläggningen, Momento Silverline™, har utvecklats i syfte att skydda miljön genom en miljövänlig tillverkningsprocess, men också att hjälpa Momentos kunder över hela världen att möta nya miljömål.

Fram till idag har svartoxidering varit den vanligaste beläggningen som använts på krafthylsor, eftersom målning eller krom inte är godkänt av ISO-standarder. År av forskning och tester har visat att Momento Silverline™, med sin ljusa silvernyans, uppfyller eller överträffar samtliga egenskaper från tidigare produkter.

We care about the environment

As part of a long term environmental initiative, Momento is the first company in the world to have successfully developed a coating without using any heavy metals in the surface treatment process.

The new coating, Momento Silverline™, has been developed with the aim to protect the environment through an environmentally friendly manufacturing process, but also to help Momento's clients worldwide to respond to new environmental targets.

Until today, black oxide has been the most common coating used on impact sockets because paint or chromium is not approved by ISO standards. Years of research and testing has proved that Momento Silverline™, with its light silver hue meets or exceeds all the performance characteristics of previous products.

Die Umwelt liegt uns am Herzen

Momento ist das weltweit erste Unternehmen, das im Rahmen einer langfristigen Umweltinitiative erfolgreich eine Beschichtung entwickelt hat, bei der keine Schwermetalle im Oberflächenbehandlungsprozess verwendet werden.

Die neue Beschichtung, Momento Silverline™, wurde mit dem Ziel entwickelt, die Umwelt durch einen umweltfreundlichen Herstellungsprozess zu schützen, aber auch den Kunden von Momento weltweit dabei zu helfen, auf neue Umweltziele zu reagieren.

Bis heute ist Schwarzoxid die am häufigsten verwendete Beschichtung für Aufprallsöckel, da Farbe oder Chrom nicht nach ISO-Normen zugelassen sind. Jahrelange Forschung und Tests haben gezeigt, dass Momento Silverline™ mit seinem hellen Silberfarbton alle Leistungsmerkmale früherer Produkte erfüllt oder übertrifft.



🇸🇪 Värmebehandling sedan 1989

En mångsidig värmebehandlingsavdelning fullt utrustad för seghårdning, mjukglödning, sätthårdning, nitrokarburering, nitring och karbonitrering säkrar de rätta egenskaperna för varje produkt. När hylsorna lämnar hårdugnarna hårdhetsprovas krafthylsor från varje parti.

🇬🇧 Heat treatment since 1989

A versatile heat treatment department fully equipped for tempering, annealing, casehardening, nitro carburizing, nitride hardening and carbonitriding secures the right properties for each product. Leaving the furnaces sockets from each batch are tested for hardness.

🇩🇪 Wärmebehandlung seit 1989

Die optimale Wärmebehandlung garantiert die gewünschten Eigenschaften eines jeden Produktes. Wir vergüten, weichglühen, einsatzhärten, nitrohärtens und karbonitrieren - je nach Bedarf. Nach Verlassen der Härteanlage werden die Steckschlüssel jeder Serie auf ihre Härte geprüft.

🇸🇪 Kvalitetskontroll

Den senaste teknologin används för att beräkna optimal hylsdimensionering. Belastningssimuleringar omfattar också mutterdragare och skruvförband.

Brothållfasthet, utmattning och slitstyrka verifieras på testutrustningar.

🇬🇧 Quality control

The latest technology is used to calculate optimal socket configurations. Stress simulation also includes nutrunning elements and fasteners.

Breaking strength, tensile strength, material fatigue, resistance to wear are verified on test equipments.

🇩🇪 Qualitätskontrolle

Mit Hilfe modernster Technologie wird die Bemessung der Steckschlüssel errechnet. Belastungssimulationen umfassen auch Mutterdreher und Schraubverbände.

Bruchfestigkeit, Dauerfestigkeit und Verschleissfestigkeit werden anhand von schlagenden und ziehenden Testausrüstungen verifiziert.



ECO FRIENDLY AND CERTIFIED

We do our best to be eco friendly, part of it is that all electricity we buy comes from hydropower. We are certified according to the current ISO Standard and we also hold quality certificates.



AB Memento: med reservation för ändringar och ev. tryckfel. Gäller för hela katalogen.
AB Memento: with reservation for changes and any misprints. Applies to the entire catalog.
AB Memento: unter Vorbehalt von Änderungen und Druckfehlern. Gilt für den gesamten Katalog.

INNEHÅLL

CONTENTS

INHALT

Viktig information	Important information	Wichtige Informationen	10-12
Safety First	Safety First	Safety First	13
I denna katalog	In this catalog	In diesem Katalog	14-17
Vi har mer	We have more	Wir haben mehr	18-23
1/4" Hylsor	Sockets	Steckschlüssel	25-35
3/8" Hylsor	Sockets	Steckschlüssel	36-60
1/2" Hylsor	Sockets	Steckschlüssel	61-98
5/8" Hylsor	Sockets	Steckschlüssel	99-102
3/4" Hylsor	Sockets	Steckschlüssel	103-125
1" Hylsor	Sockets	Steckschlüssel	126-147
1 1/2" Hylsor	Sockets	Steckschlüssel	148-163
2 1/2" Hylsor	Sockets	Steckschlüssel	164-170
3 1/2" Hylsor	Sockets	Steckschlüssel	171-173
Bits och tillbehör	Bits and accessories	Bits und Zubehör	174-175
Nutsetters	Nutsetters	Nutsetters	176-179
Insatsmejslar	Insert bits	Einsatzklingen	180-184
Hylsor för kullagermuttrar	Sockets for axial nuts	Steckschlüssel für Wellenmutter	185-189
Spline drive krafthylsor	Spline drive impact sockets	Spline drive Kraftsteckschlüssel	190-192
Förlängare	Extensions	Verlängerungen	193-196
Universalknutar	Universal joints	Kugelgelenke	197-199
Övergångar	Adapters	Reduzierstücke	200-202
Hydrauliska tillbehör	Bolting Accessories	Zubehör für Hydraulische Schraubtechnik	203-211
ePROOF System	ePROOF System	ePROOF System	212-217
Låsning	Locking	Schleusung	218-223
Satser	Sets	Satz	224-231
Måttabeller	Measure tables	Maßtabelle	232-235
Garanti	Warranty	Garantie	236-237

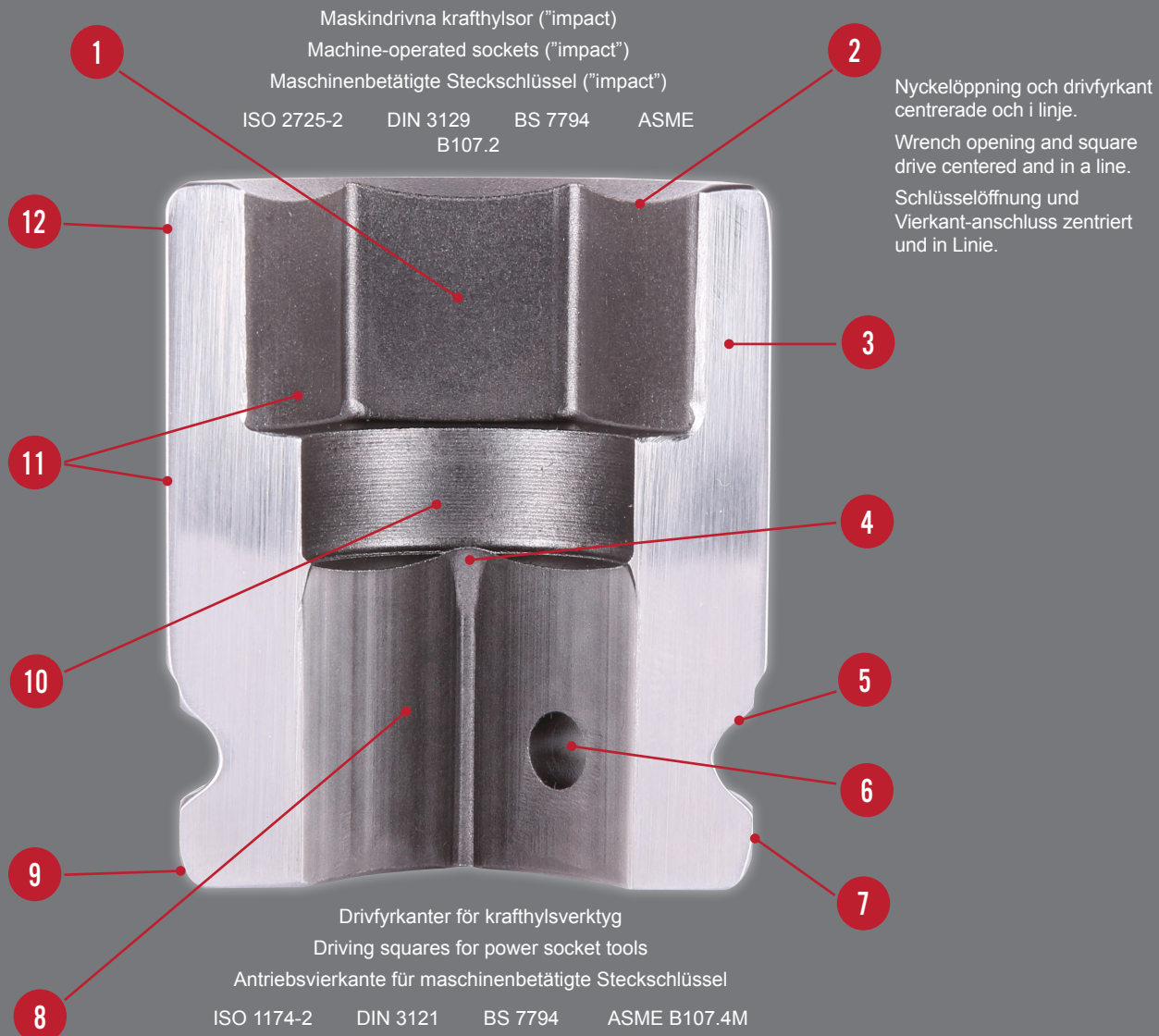

- | | | |
|---|--|--|
| <p>1 ISO691 ASME B107.17M
Nyckelöppning med högre precision.
Wrench opening with higher precision.
Schlüsselöffnung mit höherer Präzision.</p> | <p>5 Spår för O-ring.
Groove for retaining ring.
Nut für Sicherungsgummiring.</p> | <p>10 Krafthylsor skall vara försedda med frigångsdjup.
A bolt clearance hole shall be provided.
Steckschlüssel müssen Tiefenfreiheit aufweisen.</p> |
| <p>2 "Öppningen skall vara försänkt eller fasad för att underlätta ingrepp på skruvelementet."
"The opening shall be countersunk or chamfered to facilitate engagement onto the fastener."
"Die Öffnung muss versenkt oder gefast sein, um das Greifen des Schraubelementes zu erleichtern."</p> | <p>6 Hål för låspinne.
Hole for locking pin.
Öffnung für Sicherungsstift</p> | <p>11 Ytor skall vara fria från skadliga defekter som påverkar brukbarheten.
Surfaces shall be free from detrimental defects affecting serviceability.
Oberflächen dürfen keine Schadstellen aufweisen, die die Funktion beeinträchtigen.</p> |
| <p>3 Ytterdiametrar i nyckeländan är utvalda för att ge styrka och åtkomlighet.
Wrench end outside diameters are selected to provide strength and access at limited clearance.
Die Aussendurchmesser am Schlüsselende sind so gewählt, dass Stärke und Zugänglichkeit gewährleistet sind.</p> | <p>7 Ytterdiametrar i drivänden är utvalda för att hantera krafterna från alla förekommande mutterdragare.
Drive end diameters to handle the power delivered by any nutrunning machinery.
Die Aussendurchmesser am Antriebsende sind so ausgelegt, dass sie der Kraft einer jeden Antriebsmaschine übertragen können.</p> | <p>12 Utvändiga hörn skall brytas och sakna skarpa kanter.
External corners shall be broken with no sharp edges.
Äussere Ecken sind zu entschärfen. Es dürfen keine scharfen Kanten vorhanden sein.</p> |
| <p>4 Krafthylsor skall vara försedda med genomgående hål.
A through hole shall be provided.
Steckschlüssel müssen mit durchgehender Öffnung versehen sein".</p> | <p>8 Drivfyrkant med högre precision.
Square drive with higher precision.
Vierkantanschluss mit höherer Präzision.</p> | |
| | <p>9 Utvändiga hörn skall brytas och sakna skarpa kanter.
External corners shall be broken with no sharp edges.
Äussere Ecken sind zu entschärfen. Es dürfen keine scharfen Kanten vorhanden sein.</p> | |



©momento® 9-11
MADE IN SWEDEN

©momento®
MADE IN SWEDEN

IMPORTANT INFORMATION

Why you always must use impact sockets and never chromed hand sockets together with an impact wrench.

Impact wrenches are designed for very high torque – they bust bolts loose or torque them up in excess of 1000-Newton meters or foot pounds. The main problem is chrome hand sockets also will fit on an impact gun but are not designed for that amount of torque and to withstand the blows from an impact wrench. They are fairly brittle and can shatter and become a safety hazard sending fragmenting pieces in all directions.

Furthermore, the chrome plating on hand sockets can chip and make razor blade sharp flakes that can cut up your hand or other part of the body or other people around you if used together with an impact wrench.

The impact socket material is heat treated to a lower hardness range which has been optimized for impact use. This means that under heavy, continuous use, an impact socket will withstand the impact blows and will wear rather than break. That's not to say that an impact socket can't split open. The important thing to remember is that they won't shatter and send debris flying.

SILVERLINE – THE SAFE, MODERN SURFACE TREATMENT

For more than a decade, Momento has taken a clear stand on safety, responsibility, and long-term performance. Our Silverline surface treatment is completely free from toxic substances — no lead, no arsenic, no hazardous oxides, no chemicals linked to cancer or reproductive harm. Just clean, durable protection engineered for demanding industrial environments.

In contrast, many traditional black-oxide or dark-finished sockets on the market still rely on chemical processes that can involve harmful substances. Some manufacturers even publish mandatory warning statements noting that their coatings may expose users to chemicals known to cause cancer or birth defects. That is an issue we decided to eliminate entirely — over ten years ago.

By moving away from outdated black-oxide coating/finishing methods and developing Silverline, we ensure that our sockets deliver premium corrosion resistance and long service life without compromising user safety. No warnings needed. No hidden risks. No toxic residues.

Silverline reflects Momento's philosophy: high-performance tools should never come at the expense of the people who use them.

SAFETY FIRST



Always wear safety glasses when using any tool. Other personal protective equipment such as hard hat, gloves etc might also be necessary.



Periodically inspect the tools for wear and cleanliness.

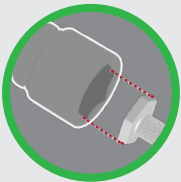

Keep the socket axis aligned with the bolt's.



2-3 seconds is usually enough when tightening using impact gun, this should be made without any unnecessary "hammering".



Use only impact sockets together with impact wrench, never hand sockets.

Securely fix sockets or attachments by ring and pin.

Be sure to disconnect power source when changing socket or bit.

Fasteners should be inserted into socket or bit correctly before operating.

Use sockets or bits suitably fitted with bolts or nuts.



Do not use sockets and bits if crack, dents, wear or deformation is found. Immediately replace all damaged tools.



Do not modify sockets and bits. Re-heated or reground will lose original quality.



TORQUE SOCKETS should not be used for loosening nuts/bolts.



These tools are not designed for use in potentially explosive atmospheres, including those caused by fumes and dust, or near flammable materials.



Torque sockets must only be used with pneumatic impact wrench of right size and right line (air) pressure.

Never hold a socket, universal joint, extension or other attachment in your hand while the power tool is running.

Do not use any tool for incorrect purpose.

These tools are not insulated against electric shock.

Do not perform idle blow of power tools with socket or bit.



Standard krafthylsor

Drivände med 4-kantsfäste: 1/4"-3 1/2"
Standard nyckelvidd 4-255 mm.

Den klassiska 6-kants krafthylsan för alla typer av användning.



Standard impact sockets

Available for square drives: 1/4"-3 1/2"
Wrench widths of 4-255 mm as standard.

The classic 6-point socket for all types of use.



Standard Kraftsteckschlüssel

Verfügbar mit Antriebsvierkant: 1/4"-3 1/2"
Schlüsselweiten von 4-255mm im Standardprogramm enthalten.

Klassische 6-kant Nüsse für alle Arten von Anwendungen



Tunnväggiga (T)

Drivände med 4-kantsfäste: 3/8"-1"
Nyckelvidd 6-60 mm.

För bättre åtkomst i trånga utrymmen.

OBS! Tunnväggiga krafthylsor skall inte användas med slående mutterdragare.



Thin wall (T)

Available for square drives: 3/8"-1"
Wrench width between 6-60 mm.

For better access in tight applications.

NOTE! The thin-walled socket should not be used with impact wrenches.



Dünnwandig (T)

Verfügbar mit Antriebsvierkant: 3/8"-1".
Schlüsselweiten von 6-60 mm im Standardsortiment.

Für besseren Zugang bei schwer zugänglichen Anwendungsfällen.

HINWEIS! Dünnwandige Kraftnüsse sollten nie mit Schlagschraubern verwendet werden.



Långa (L)

Finns i olika utföranden som dubbel 6-kant (D6K), surface drive m m.

Drivände med 4-kantsfäste: 3/8"-2 1/2"
Nyckelvidd 4-170 mm.

Den långa krafthylsan gör det möjligt att nå muttern även om skruven sticker upp ovanför muttern.



Long (L)

Available in different variants such as double hexagon (D6K), surface and others.

Available for square drives: 3/8"-2 1/2"
Wrench widths between 4-170 mm.

The long socket makes it possible to reach the nut even if the screw protrudes above the nut.



Lange Ausführung (L)

Verfügbar in vielen verschiedenen Varianten wie z. B. als Doppelsechskant-Ausführung (D6K), Surface Drive und weitere.

Verfügbar mit Antriebsvierkant: 3/8"-2 1/2". Schlüsselweiten von 4-170mm im Standardsortiment.

Die lange Version ermöglicht Ihnen, tiefliegende Anwendungsfälle problemlos zu erreichen.



Dubbel 6-kant (D6K)

D6K betyder dubbel 6-kant. Dessa hylsor ska i första hand användas till skruvar med dubbel 6-kantshuvud.

Drivände med 4-kantsfäste: 1/2"-1 1/2"
Nyckelvidd 10-105 mm.

Finns även i tunnväggigt utförande.



12-point sockets (D6K)

D6K means double 6-edge. These sockets should primarily be used for bolts with 12 point heads.

Available for square drives : 1/2"-1 1/2"
Wrench width between 10-105 mm.

Also available in thin-wall design.



12-kant Steckschlüssel (D6K)

Mit D6K ist Doppelsechskant gemeint. Diese Steckschlüssel sollten hauptsächlich für Schrauben mit 12-Kant-Köpfen verwendet werden.

Verfügbar mit Antriebsvierkant: 1/2" – 1 1/2". Schlüsselweiten von 10-105mm im Standardprogramm enthalten. Auch in dünnwandiger Ausführung erhältlich.



Surface drive (SF)

Surface drive kraftthylsor är speciellt framtagna för monteringsmaskiner. Särskilt lämpade för flerspindlig montering.

Drivände med 4-kantsfäste: 3/8"-1"
Nyckelvidd 8-36 mm.



Surface drive (SF)

Surface drive power sockets are designed primarily for assembly machines. Particularly suitable in multiple mounting.

Available for square drives: 3/8"-1"
Key widths between 8-36 mm.



Surface drive (SF)

Surface Drive Kraftsteckschlüssel sind hauptsächlich für Montagemaschinen konzipiert worden. Besonders geeignet bei Mehrfachmontage.

Verfügbar für Antriebsvierkant: 3/8"-1".
Schlüsselweiten von 8-36mm im Standardprogramm enthalten.



Mellanstycken (PA, IPA & UK)

Vi har ett brett sortiment av mellanstycken och universalknutar för ökad flexibilitet mellan olika hylsanslutningar och drivtappar på maskinen. Med Momentos kompakta insatsövergångar till mindre fyrkant reduceras bygghöjden till ett minimum. IPA är försedd med magnet som håller dem i rätt läge.



Adapters (PA, IPA & UK)

We have a wide range of adapters and universal joints for increased flexibility between different socket connections and drive lugs on the machine. With Momento's compact efforts reduced overall height to a minimum. IPA is provided with magnet that keep them in the right position.



Adapter (PA, IPA & UK)

Momento verfügt über ein breites Sortiment an Verbindungsteilen und Kugelgelenk-Verbindungen, um Kraftsteckschlüssel flexibel für viele Anwendungsfälle nutzen zu können. Durch die kompakte Bauweise konnte die Gesamtlänge auf ein Minimum reduziert werden. Die IPA Serie verfügt über zusätzliche Magnete, die dabei helfen, den Schrauber immer in richtiger Position zu halten.



Förlängare (EB)

Drivände med 4-kantsfäste: 1/4"-2 1/2"
Förlängningar finns i många olika längder.

De små modellerna har låsning med fjädrande stift.
Större modeller har genomgående hål för låsningen.



Extensions (EB)

For square drives: 1/4"-2 1/2"
Extensions are available in several different lengths.

The smaller models have locking with spring pin.
The larger models have through holes for the locking pin.



Verlängerungen (EB)

Verfügbar mit Antriebsvierkant: 1/4"-2 1/2".
In vielen verschiedenen Längen erhältlich.

Kleine Vierkante mit federndem Stift erhältlich. Größere Vierkante mit durchgehender Bohrung zur Absicherung mit Sicherungsring und Sicherungsstift erhältlich.



Kulledshylsor (US)

Momentos kulledshylsor är fjäderbelastade och kan ställas i önskad vinkel. (Max 30° för kraftverktyg).
Drivände med 4-kantsfäste: 1/2", 3/8". Nyckelvidd 13-24 mm.
Tillverkas både i kort och långt utförande.

OBS! Kulledshylsor skall inte användas med slående mutterdragare.



Universal sockets (US)

Momento's universal sockets are spring loaded and can be set to the desired angle. (30° for power tools.) For square drive: 1/2", 3/8". Wrench widths between 13-24 mm. Available in both short and long version.

NOTE! The universal socket should not be used with impact wrenches.



Gelenk-Steckschlüssel (US)

Die Gelenk-Steckschlüssel sind federbelastet und können auf den gewünschten Winkel eingestellt werden (max. 30° Abwinkelung für Schlageinsätze). Verfügbar mit Antriebsvierkant: 1/2". Schlüsselweiten von 13-24mm Verfügbar in Kurz- und Langversion.

HINWEIS! Gelenk-Steckschlüssel sollten nie mit Schlagschraubern verwendet werden.



För kullagermuttrar (KM)

KM hylsor för montering / demontering av lagermuttrar. De ersätter haknycklar och gör det möjligt att använda mutterdragare eller momentnyckel.

Drivande med 4-kantsfäste: 3/8"-1" från KM-0 och uppåt.



Axial nut sockets (KM)

KM sockets for mounting/dismounting of bearings nuts. They replace hook keys and makes it possible to use the impact wrench or torque wrench.

Available for square drives: 3/8"-1" from KM-0 and up.



Steckschlüssel für Wellenmuttern (KM)

KM-Steckschlüssel sind für das Ein- und Ausdrehen von Lagermuttern geeignet. Sie ersetzen Hakenschlüssel und ermöglichen die Verwendung eines Schlag- oder Drehmomentschlüssels.

Verfügbar für Antriebsvierkant: 3/8"-1" ab KM-0.



Pinnbultshylsor

Hylsor för montering av pinnbultar. Vi har ett stort urval av pinnbultshylsor, både mm och tum.

Drivande med 4-kantsfäste: 1/2"-1" Gänga: M6-M48 (finns även gänga med tumstorlek).



Stud runner sockets

Bolt bushings for mounting studs. We have a wide range of both metric and inch thread studs.

For square drives: 1/2"-1" Thread: M6-M48 (also available with thread of inch).



Stehbolzensteckschlüssel

Stehbolzensteckschlüssel sind für das Befestigen von Gewindebolzen geeignet. Wir haben eine große Auswahl an metrischen und zöllischen Abmessungen.

Verfügbar für Antriebsvierkant: 1/2"-1" Gewinde: M6-M48 (auch mit zöllischem Gewinde erhältlich)



Verktygsfästen och bits

Vi har bitshållare för drivande med 4-kantsfäste: 3/8"-1 1/2"

Bits finns från 5-50 mm sexkant och motsvarande tumstorlekar. Biten låses med en spetsig skruv.



Holder and bits

We have bit holders with square drives: 3/8"-1 1/2"

Bits are from 5-50 mm hexagon and corresponding inch sizes. Bits is locked with a pointed screw.



Halter und Bits

Bit-Halter mit einem Antriebsvierkant von: 3/8"-1 1/2" verfügbar

Sechskant-Bits von 5-50mm und entsprechenden zöllischen Abmessungen verfügbar. Bits sind zur Befestigung mit einer Madenschraube geeignet.



Fyrkantshylsor (4K)

Fyrkantshylsor används för att dra åt skruvar med fyrkantshuvuden.

Finns för drivande med 4-kantsfäste: 3/8"-1" Nyckelvidd: 5-46 mm (finns även i motsvarande tumstorlekar).



4-point sockets (4K)

Square sockets used to tighten screws with square heads.

Available for square drives: 3/8"-1" Wrench width: 5-46 mm (also available in corresponding inch sizes).



4-kant Steckschlüssel (4K)

4-Kant Steckschlüssel sind zur Befestigung von 4-Kant Schrauben geeignet.

Verfügbar für Antriebsvierkant: 3/8"-1" Schlüsselweiten von: 5-46 mm (auch mit den entsprechenden zöllischen Abmessungen verfügbar).



Hylssatser

I vårt sortiment finns även satser med krafthylsor i olika storlekar för att passa dina behov. Sexkantshylsor, torx, långa, IPA och momenthylsor är några exempel.



Socket sets

In our catalog you also find sets of sockets in different sizes to meet your needs. Hexagon, Torx, Long, IPA and Torque sockets are some examples.



Steckschlüssel sets

In unserem Katalog finden Sie verschiedenste Kombinationen für Ihre Bedürfnisse. Außensechskant, TX, lang, IPA und Drehmomentssteckschlüssel sind einige Beispiele.

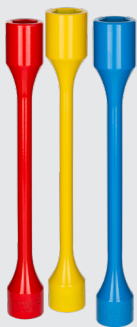

Momenthylsor (NMC)

Momenthylsor är konstruerade för åtdragning av hjulmuttrar med slående mutterdragare. Den långa och smala midjan dämpar överskottskraften ifrån mutterdragaren.

Nyckelvidd: 17-21 mm.
Drivande med 4-kantsfäste: 1/2", 3/4", 1". Färgkodade för identifiering av det önskade vridmomentet.



Torque Sockets (NMC)

Torque sockets are designed for tightening of automobile wheels with impact wrenches. The long and narrow waist dampens excess power of the wrench.

Wrench width: 17-21 mm.
Square drive: 1/2", 3/4", 1".
Colour coding for identification of the desired torque.



Drehmomentsteckschlüssel

Drehmoment-Steckschlüssel sind zum Anziehen von Autorädern mit Schlagschraubern geeignet. Die lange und schmale Taille dämpft überschüssige Kraft des Schraubers.

Schlüsselweiten : 17-21 mm.
Vierkanttrieb: 1/2", 3/4", 1".
Farbcodierung zur Identifizierung des gewünschten Drehmoments.



SilverLine™ Cover

Vid arbete med skruvdragning på känsliga ytor (t ex lackerade detaljer inom bilindustrin) behövs en skyddad krafthylsa för att undvika repor och lackskador. Momentos Silverline-skydd finns för 6-kant-, Six Lobe-, magnet-, 12-kant- och surface drive hylsor. Finns för drivande med 4-kantsfäste: 3/8 - 3/4"
Nyckelvidd mellan 6-24 mm.



Silverline™ Cover

When working with screwdriving on sensitive surfaces (for example lacquered steel in the automotive industry) it needs a protected socket to avoid scratches and paint damage. Momento's Silverline™ Cover is available in both 6-edge and Six Lobe performance from 3/8"-3/4" square drive and wrench width between 6-24 mm.



Silverline™ Cover

Bei der Arbeit mit Schrauben auf empfindlichen Oberflächen (z. B. lackiertem Stahl in der Automobilindustrie) ist eine geschützte Kraftnuss erforderlich, um Kratzer und Lackschäden zu vermeiden. Die Silverline™ Cover von Momento sind sowohl mit 6-Kant-, als auch mit Six Lobe, 3/8"-3/4" Vierkanttrieb und einer Schlüsselweite zwischen 6 und 24 mm erhältlich.

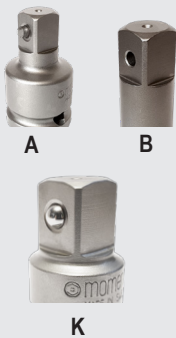

Låsning

Den utvändiga fyrkanten på Momentos 1/4", 3/8", 1/2" och 5/8" förlängningar, universalknutar och övergångar har låsning med fjädrande stift (A).
Ovan nämnda kan även fås med fjädrande kula (K) som låsning, lägg till ett "K" efter artikelnumret för utförande med kula.
Alla större utvändiga fyrkanter har genomgående hål (B) för låspinne.



Locking

The standard external square of Momento's 1/4", 3/8", 1/2" and 5/8" extensions, universal joints and adapters has a plunger retainer (A).
The above mentioned can also be supplied with spring ball as locking (K), add a "K" for the part number for the version with ball.
All larger external squares have a through pinhole (B).



Verriegeln

Die Aussenvierkante der Momento Verlängerungen, Kugelgelenke und Reduzierstücke 1/4", 3/8", 1/2" und 5/8" sind mit federndem Stift versehen (A). Oben erwähnt kann auch verwendet werden Federkugel als Schloss geliefert werden (K). Fügen Sie dazu ein "K" hinzu Teilenummer der Version mit Kugel hinzugefügt.
Alle grösseren Aussenvierkante haben ein durchgehendes Stiftloch (B).

🇸🇪 Vi har mer

Utöver sortimentet som presenteras i denna katalog har vi mer att erbjuda. På följande sidor visar vi andra delar i vårt sortiment som ni kan läsa mer om i andra broschyrer och på vår hemsida.

🇬🇧 We have more

In addition to the range presented in this catalog, we have more to offer. On the following pages we show other parts of our range that you can read more about in other brochures and on our website.

🇩🇪 Wir haben mehr

Neben dem in diesem Katalog vorgestellten Sortiment haben wir noch mehr zu bieten. Auf den folgenden Seiten zeigen wir Ihnen weitere Teile unseres Sortiments, über die Sie in anderen Broschüren und auf unserer Website mehr erfahren können.

Need more information?

At our website you can find our catalogs and all information you need regarding our range.



🇸🇪 Hydrauliska verktyg

I vårt sortiment hittar du allt du behöver för att få jobbet gjort på ett säkert och effektivt sätt. Vi erbjuder pumpar, cylindrar, verktyg och tillbehör som enkelt kan kopplas samman till den funktion som behövs för just din applikation.

🇬🇧 Hydraulic tools

In our range you will find everything you need to get the job done safely and efficiently. We offer pumps, cylinders, tools and accessories that can be easily connected to the function that is needed for your application.

🇩🇪 Hydraulische Werkzeuge

In unserem Sortiment finden Sie alles, was Sie brauchen, um die Arbeit sicher und effizient zu erledigen. Wir bieten Pumpen, Zylinder, Werkzeuge und Zubehör an, die einfach an die für Sie erforderliche Funktion angeschlossen werden kann.

🇸🇪 Bits och tillbehör

Vi har ett utökat program med bits och tillbehör. Vårt bitprogram är, som våra andra produkter, av hög kvalitet som uppfyller krav enligt gällande standarder.

🇬🇧 Bits and accessories

We have an expanded program of bits and accessories. Our bit program, like our other products, is of a high quality that meets the requirements of current standards.

🇩🇪 Bits und Zubehör

Wir haben ein breites Sortiment an Bits und Zubehör. Wir sparen auch nicht an Qualität mit unseren Bits. Hierbei garantieren wir eine stets gleichbleibende Qualität, die den DIN- und Marktanforderungen jederzeit standhalten können.

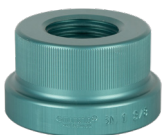

🇸🇪 Hydrauliska momentverktyg

Vi erbjuder två alternativa serier med lite olika funktioner så att du som användare kan hitta det verktyg som passar din applikation bäst. I vår katalog för hydrauliska momentverktyg, och på vår hemsida, hittar du allt du behöver för att göra ett säkert och bra arbete när du ska dra moment.

🇬🇧 Hydraulic Bolting tools

We offer two alternative series with slightly different features so you as a user will find the tool that suits your application best. In our Hydraulic Bolting catalog, and at our website, you will find everything you need for tightening your bolts with right torque.

🇩🇪 Hydraulische Schraubwerkzeuge

Wir bieten zwei alternative Baureihen mit leicht unterschiedlichen Ausstattungsmerkmalen an, sodass Sie als Anwender das für Ihren Anwendungsfall am besten geeignete Werkzeug finden können. In unserem Katalog finden Sie alles, was Sie zum Anziehen Ihrer Schrauben mit dem richtigen Drehmoment benötigen.

🇸🇪 Delta Sigma

Are you in control of the strength and safety of your screw joints? Momento has the answer: The new Delta Sigma ultrasonic instrument for easy measuring of clamping force in fasteners. No more broken or lose screws!

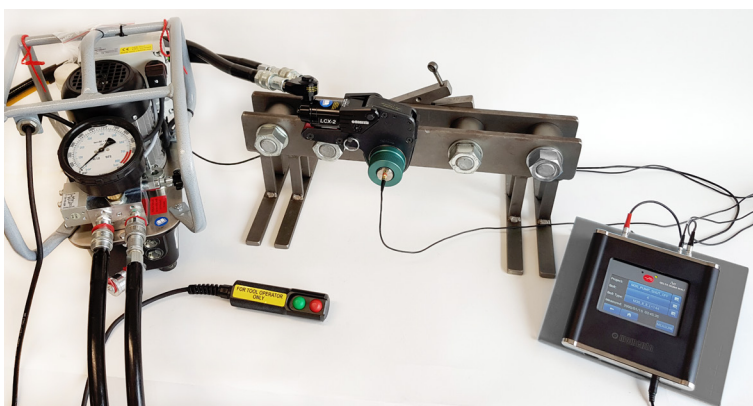

🇬🇧 Delta Sigma

Are you in control of the strength and safety of your screw joints? Momento has the answer: The new Delta Sigma ultrasonic instrument for easy measuring of clamping force in fasteners. No more broken or lose screws!

🇩🇪 Delta Sigma

Haben Sie die Festigkeit und Sicherheit Ihrer Schrauben unter Kontrolle? Momento hat die Antwort: Das neue Delta Sigma Ultraschallgerät zur einfachen Messung der Klemmkraft in Verbindungselementen. Keine gebrochenen oder losen Schrauben mehr!



🇸🇪 ePROOF System

Momento ePROOF SYSTEM isolerade adaptrar ger skydd mot elektrostatisk urladdning upp till 1000 V och minskar riskerna som är förknippade med höga strömmar, spänningssatta komponenter, kortslutningar och jordfel vid arbete med handverktyg.



🇬🇧 ePROOF System

Momento ePROOF SYSTEM Insulated/ Isolated Adapters provide protection against electrostatic discharge up to 1000V, reducing risks associated with high currents, live components, short-circuits, and grounding with tools.

🇩🇪 ePROOF System

Die isolierten Adapter des Momento ePROOF SYSTEMS bieten Schutz vor elektrostatischer Entladung bis zu 1000 V und reduzieren Risiken im Zusammenhang mit hohen Stromstärken, spannungsführenden Komponenten, Kurzschlüssen sowie unbeabsichtigter Erdung über Werkzeuge.



SilverLine™ Cover plastskydd

SilverLine™ Cover är gjorda av slitstarkt plastmaterial som ger en skyddande barriär mellan din Momento SilverLine™ krafthylsa och den färdiga fina ytan på arbetsstycket, t ex en lackad bildörr.

Konstruktionen är sådan att den invändiga hylsan kan rotera fritt i förhållande till det yttre plastskyddet, detta innebär att plastskyddet slutar rotera vid kollision mot ett annat föremål, vilket ger ett bra skydd för polerade, lackade och andra högkänsliga ytor. Att undvika denna typ av skador ger stora vinster i såväl tid som pengar på en monteringslina för fordon.

SilverLine™ Cover har också en annan fördel. Det förbättrar säkerheten och minskar risken för skador. Roterande verktyg kan orsaka olyckor för operatören, t ex genom att man fastnar med handskar eller kläder. Genom användning av SilverLine™ Cover kan denna typ av skador kraftigt begränsas.

Om plastskyddet blir utslitet kan det enkelt bytas ut mot ett nytt till samma krafthylsa. Artikelnummer för endast plastskyddet samt även för komplett krafthylsa med monterat plastskydd hittar ni i produktlistorna i denna katalog.

SilverLine™ Cover plastic covers

SilverLine™ Cover is made of a durable plastic material that provides a protective barrier between your Momento SilverLine™ socket and the final fine surface on the workpiece. The free spinning design provides high protection for polished, painted and high sensitive surfaces. Avoiding these kind of damages gives high economic efficiency factors for a vehicle production line.

SilverLine™ Cover also has another benefit. It improves safety and avoids injury. Rotating tools can cause accidents to the operator such as wrap of gloves or clothing. The injuries caused of that can be avoided reliably and significantly by the use of our SilverLine™ Cover tools.

If the cover becomes worn, it can easily be replaced with a new one on the same socket. Part numbers for only plastic cover as well as complete protected socket can be found in the product charts in this catalog.

SilverLine™ Cover Kunststoffabdeckungen

Die SilverLine™ Cover besteht aus einem haltbaren Kunststoff, der eine Schutzbarriere zwischen Ihrer Momento SilverLine™ Steckschlüssel und der endgültigen feinen Oberfläche des Werkstücks bildet. Das frei drehende Design bietet hohen Schutz für polierte, lackierte und hochempfindliche Oberflächen. Die Vermeidung dieser Art von Schäden führt zu hohen Wirtschaftlichkeitsfaktoren für eine Fahrzeugproduktionslinie.

SilverLine™ Cover hat noch einen weiteren Vorteil. Es verbessert die Sicherheit und vermeidet Verletzungen. Rotierende Werkzeuge können Unfälle für den Bediener verursachen, z. B. das Umwickeln von Handschuhen oder Kleidung. Die dadurch verursachten Verletzungen können durch den Einsatz unserer SilverLine™ Cover-Werkzeuge zuverlässig und erheblich vermieden werden.

Wenn die Abdeckung abgenutzt ist, kann sie leicht durch eine neue in derselben Steckschlüssel ersetzt werden. Die Teilenummern nur für Kunststoffabdeckungen sowie für die vollständig geschützte Steckschlüssel finden Sie in den Produkttabellen in diesem Katalog.



**CUSTOM
MADE
PRODUCTS**

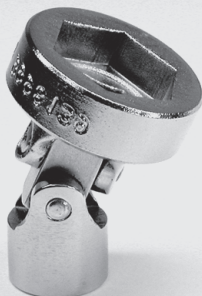
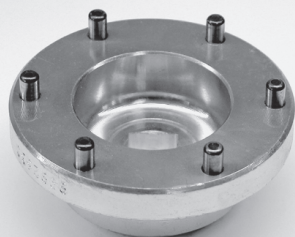
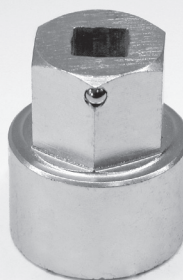

WE DESIGN FOR YOUR SPECIFIC NEEDS













Här visas några få exempel på verktyg tillverkade för enskilda kunders speciella behov. Vi designar det du behöver.



Here are a few examples of tools made for the specific needs of individual customers. We design what you need.



Hier einige Beispiele für Tools, die auf die spezifischen Bedürfnisse einzelner Kunden zugeschnitten sind. Wir gestalten, was Sie brauchen.

	Symboler	Symbols	Symbole	
		Invändig fyrkant	Female square	Innen-Vierkant
		Utvändig fyrkant	Male square	Aussen-Vierkant
		Invändig sexkant	Female hexagon	Innen-Sechskant
		Utvändig sex kant	Male hexagon	Aussen-Sechskant
	 	Nyckelvidd	A/F size	Schlüsselweite
		Kullagermutter	Ball bearing nut	Kugellagermutter
		Gänga	Thread	Gewinde
		Invändig spline	Female spline	Innen-Spline
		Vikt	Weight	Gewicht

	Drivändekod	Drive end code	Antriebskode
1/4"	0	0	0
3/8"	1	1	1
1/2"	4	4	4
5/8"	8	8	8
3/4"	2	2	2
1"	9	9	9
1 1/4"	3	3	3
1 1/2"	5	5	5
2 1/2"	6	6	6
3 1/2"	12	12	12
No. 5 Spline	7	7	7

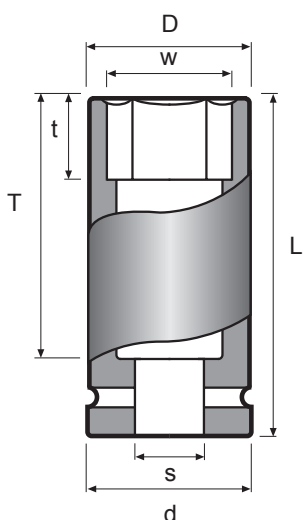

d	Diameter drivände	d	Diameter at drive end	d	Durchmesser, Antriebsseite
s	Drivanslutning	s	Drive connection	s	Antrieb
T	Frigångsdjup	T	Bolt clearance depth	T	Eintauchtiefe Bolzen
t	Nyckeldjup	t	Depth of wrench opening	t	Eintauchtiefe
L	Längd	L	Overall length	L	Länge
w	Nyckelöppning	w	Wrench opening A/F	w	Schlüsselweite
D	Diameter nyckelände	D	Diameter at wrench end	D	Durchmesser, Schlüsselseite

1/4"



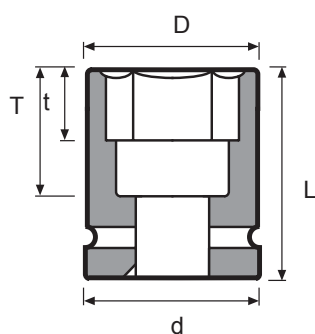

Part No.	D mm	d mm	L mm	t mm	T mm	kg
4 0-4	7,6	13	25	4	15	0,01
5 0-5	8,9	13	25	4	15	0,02
5,5 0-5,5	9,5	13	25	4	15	0,02
6 0-6	10,1	13	25	4	15	0,02
7 0-7	11,4	13	25	5	15	0,02
8 0-8	12,6	13	25	5	15	0,02
9 0-9	13,9	13	25	5	15	0,01
10 0-10	15,1	13	25	7	15	0,02
11 0-11	16,4	13	25	7	15	0,02
12 0-12	17,6	13	25	7	14	0,02
13 0-13	18,9	13	25	8	14	0,02
14 0-14	20,1	13	25	10	14	0,02
15 0-15	21	16	30	10	20	0,04
16 0-16	22	16	30	10	20	0,06
8 0-8L	12,6	13	57	5	48	0,04
10 0-10L	15,1	13	57	7	48	0,04
12 0-12L	17,6	13	57	7	48	0,04
13 0-13L	18,9	13	57	8	48	0,07
3/16 0-3/16	8,9	13	25	4	15	0,01
1/4 0-1/4	10,1	13	25	4	15	0,02
5/16 0-5/16	12,6	13	25	5	15	0,02
3/8 0-3/8	15,1	13	25	7	15	0,02
7/16 0-7/16	16,4	13	25	7	15	0,02
1/2 0-1/2	18,9	13	25	8	14	0,03
9/16 0-9/16	20,1	13	25	10	16	0,04
5/8 0-5/8	22	16	30	10	20	0,01

Can't find what you're looking for?

We can manufacture special tools to meet your individual requirements.

Contact us and we will help you!

Magnetiska krafthylsor
Fast magnet

Magnetic impact sockets
Solid magnet

Magnetische Kraftsteckschlüssel
Dauermagnet

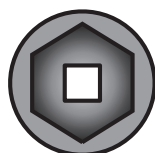
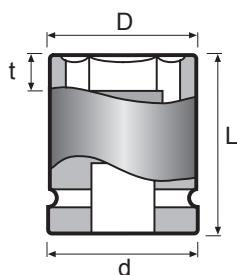

We use neodym magnets. They are 11 times stronger than ferrite magnets.

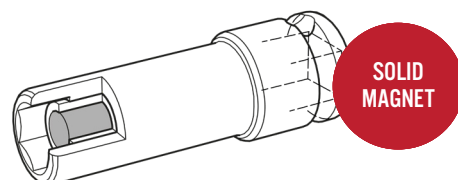
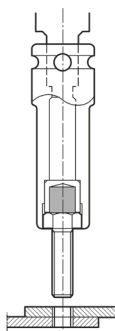

Part No	D mm	d mm	L mm	t mm	kg
6 0-6M	10,1	13	25	2,5	0,02
7 0-7M	11,4	13	25	2,5	0,02
8 0-8M	12,6	13	25	3	0,02
9 0-9M	13,9	13	25	3	0,02
10 0-10M	15,1	13	25	5	0,02
11 0-11M	16,4	13	25	5	0,02
12 0-12M	17,6	13	25	5	0,03
13 0-13M	18,9	13	25	5	0,03
1/4 0-1/4M	10,1	13	25	2,5	0,02
5/16 0-5/16M	12,6	13	25	3	0,02
3/8 0-3/8M	15,1	13	25	5	0,02
7/16 0-7/16M	16,4	13	25	5	0,02

Part No	D mm	d mm	L mm	t mm	kg
8 0-8ML	12,6	13	57	3	0,04
10 0-10ML	15,1	13	57	5	0,05
12 0-12ML	17,6	13	57	5	0,06
13 0-13ML	18,9	13	57	5	0,07

Magnetiska krafthylsor
Fjädrande magnet

Magnetic impact sockets
Retracting magnet

Magnetische Kraftsteckschlüssel
Federndem Magnet

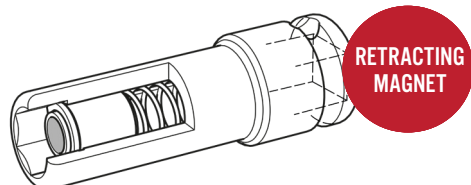
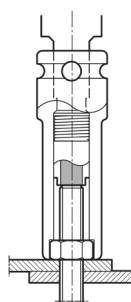
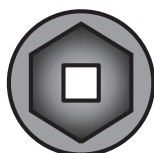

Part No	D mm	d mm	L mm	t mm	kg
8 0-8RML	12,6	13	57	3	0,04
10 0-10RML	15,1	13	57	5	0,05
12 0-12RML	17,6	13	57	5	0,06
13 0-13RML	18,9	13	57	5	0,07

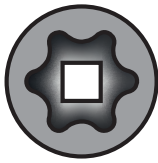
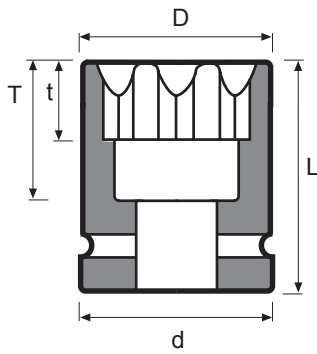

Part No	D mm	d mm	L mm	t mm	T mm	kg
E4 0-E4	7	13	25	4	15	0,01
E5 0-E5	7,8	13	25	4,5	15	0,01
E6 0-E6	8,8	13	25	5,0	15	0,01
E7 0-E7	9	13	25	5	15	0,01
E8 0-E8	9,7	13	25	6	15	0,01
E10 0-E10	13	13	25	6,5	15	0,01

 Passar till på marknaden vanligt förekommande skruvar med hexalobulärt grepp.

 Fits on the market commonly used screws with hexalobular driving feature.

 Passend zu den auf dem Markt gängigen Schrauben mit Innensechsrund Antrieb

Förlängare

Extensions

Verlängerungen

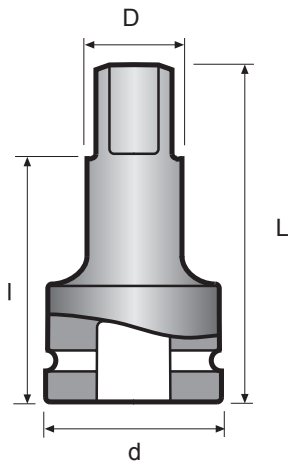

Part No	Model	D mm	d mm	L mm	I mm	kg
1/4 1/4 EB00-2	A	8,2	13	51	43,5	0,03
1/4 1/4 EB00-3	A	8,2	13	76	68,5	0,04
1/4 1/4 EB00-4	A	8,2	13	102	94,5	0,05
1/4 1/4 EB00-5	A	8,2	13	127	119,5	0,06
1/4 1/4 EB00-6	A	8,2	13	153	145,5	0,07

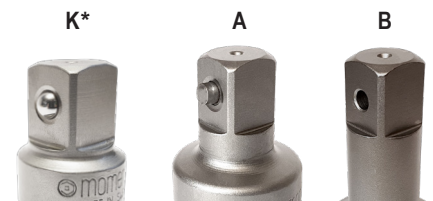

 * K: Våra 1/4", 3/8", 1/2" och 5/8" förlängare kan även fås med fjädrande kula som låsning, lägg till ett "K" efter artikelnumret för utförande med kula.

 * K: Our 1/4", 3/8", 1/2" and 5/8" extensions can also be supplied with spring ball as locking, add a "K" for the part number for the version with ball.

 * K: Unsere 1/4", 3/8", 1/2" und 5/8" verlängerungen können auch mit Federkugel als Verriegelung geliefert werden. Fügen Sie ein "K" für die Teilenummer der Version mit Kugel hinzu.

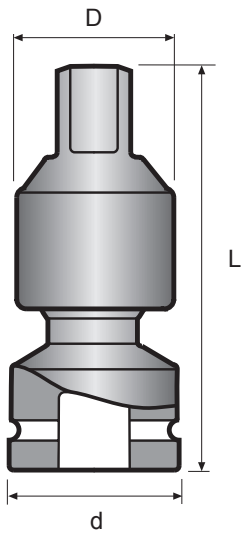

		Part No	Mod.	D mm	d mm	L mm	kg
1/4	1/4	UK00	A	17	13	43	0,04

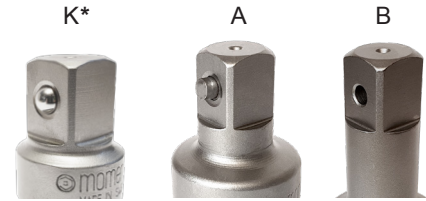

* K: Våra 1/4", 3/8", 1/2" och 5/8" universalknutar kan även fås med fjädrande kula som låsning, lägg till ett "K" efter artikelnumret för utförande med kula.

* K: Our 1/4", 3/8", 1/2" and 5/8" universal joints can also be supplied with spring ball as locking, add a "K" for the part number for the version with ball.

* K: Unsere 1/4", 3/8", 1/2" und 5/8" Universalgelenke können auch mit Federkugel als Verriegelung geliefert werden. Fügen Sie ein "K" für die Teilenummer der Version mit Kugel hinzu.

Momentos 1/4", 3/8" och 1/2" universalknutar är fjäderbelastade och kan ställas i önskad vinkel.

1/4", 3/8" and 1/2" Momento universal joints are spring loaded and can be preset at an angle.

Momento Kugelgelenke mit 1/4", 3/8" und 1/2" Vierkantantrieb sind federbelastet und auf Winkel einstellbar.



Need another size?

We can manufacture special tools to meet your individual requirements. Contact us and we will help you!

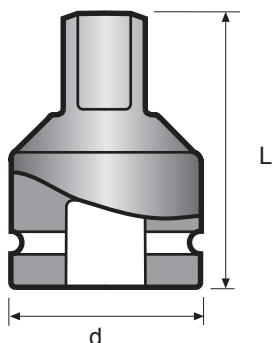

		Part No	Mod.	d mm	L mm	kg
1/4	3/8	PA01	A	13	28	0,02

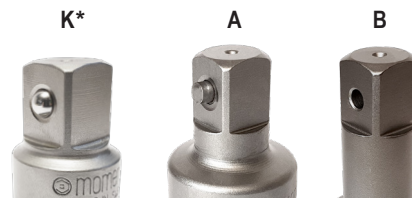

Var försiktig vid övergång till mindre fyrkant. Då mutterdragaren kan ge ett för högt vridmoment för den mindre tappan, lämnas ingen garanti.

Be careful when adapting to a smaller drive. As the power input may be too high for the smaller drive square, there is no guarantee when adapting down.

Seien Sie vorsichtig beim Übergang zu kleinen Antriebsvierkanten. Da das Drehmoment für den kleinen Vierkant zu hoch sein kann, kann keine Garantie übernommen werden.

* K: Våra 1/4", 3/8", 1/2" och 5/8" övergångar kan även fås med fjädrande kula som låsning, lägg till ett "K" efter artikelnumret för utförande med kula.

* K: Our 1/4", 3/8", 1/2" and 5/8" adapters can also be supplied with spring ball as locking, add a "K" for the part number for the version with ball.

* K: Unsere 1/4", 3/8", 1/2" und 5/8" reduzierstücke können auch mit Federkugel als Verriegelung geliefert werden. Fügen Sie ein "K" für die Teilenummer der Version mit Kugel hinzu.

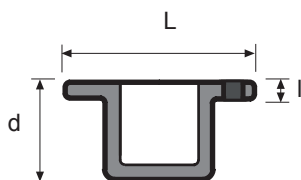
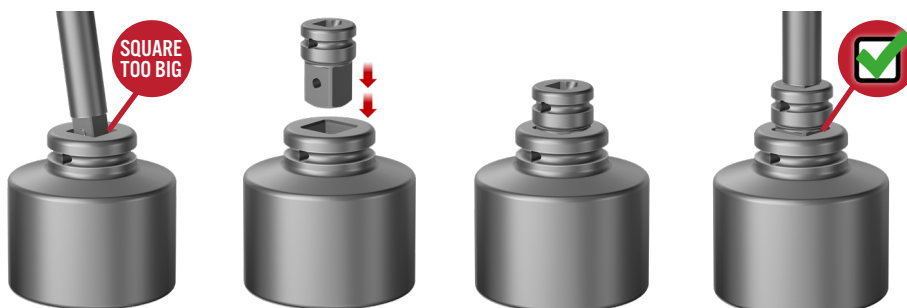

		Part No	d mm	L mm	l mm	kg
1/4	3/8	IPA01	22	14	3	0,02

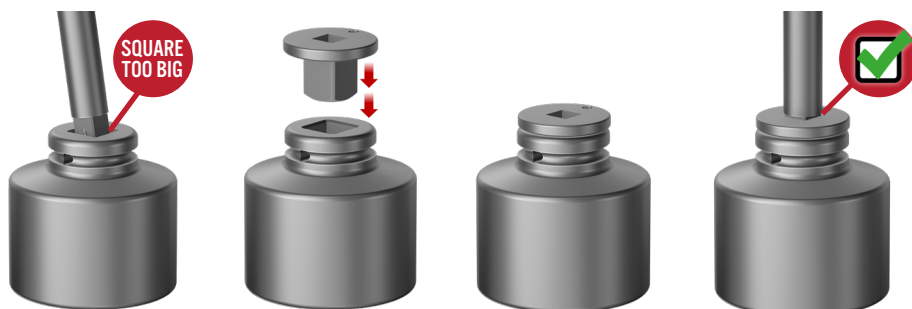

The total height

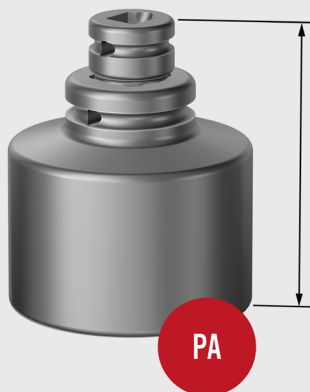
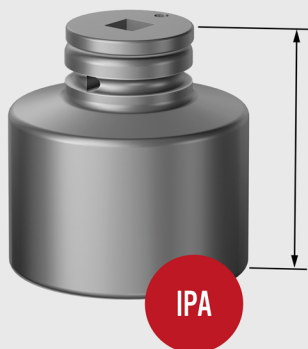

Secured with



i Info about different types of securing in the beginning of the catalogue.

The differens between IPA and PA adapters

There are some facts that you need to know to be able to pick the best adapter for your job.



PA

- Säkras med Momento Locking, Ret ring eller Pinne och O-ring.
- Kräver större utrymme än IPA
- Secured with Momento Locking, Ret ring or Pin and O-ring.
- Requires more space than IPA
- Mit Momento Locking, Ret-Ring oder Sicherungsstifte und O-Ringe gesichert.
- Benötigt mehr Platz als IPA

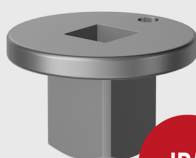

IPA

- Används när utrymmet är begränsat
- Kan inte säkras med pinne och O-ring (Insatsövergången hålls kvar i hylsan med hjälp av en magnet)
- Used when space is limited
- Cannot be secured with pin and O-ring (The insert adapter sticks to the socket by means of a magnet)
- Wird verwendet, wenn der Platz begrenzt ist
- Kann nicht mit Sicherungsstifte und O-Ringe gesichert werden (Ein Magnet hält das Reduzierstück am Kraftsteckschlüssel)

Krafthylsor

Impact Socket

Kraftsteckschlüssel

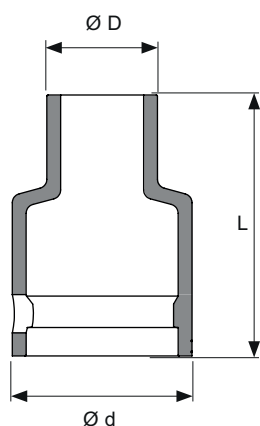

SIZE	FITS ON SOCKET	SOCKET WITH COVER	PLASTIC COVER	Ø d	Ø D	L
<i>METRIC</i>						
5	0-5	0-5RP	PC0-5	16,7	12,4	25,5
6	0-6	0-6RP	PC0-6	16,7	13,8	25,5
7	0-7	0-7RP	PC0-7	16,7	15,1	25,5
8	0-8	0-8RP	PC0-8	16,7	16,3	25,5
9	0-9	0-9RP	PC0-9	16,7	17,6	25,5
10	0-10	0-10RP	PC0-10	16,7	18,8	25,5
11	0-11	0-11RP	PC0-11	16,7	20,1	25,5
12	0-12	0-12RP	PC0-12	16,7	21,3	25,5
13	0-13	0-13RP	PC0-13	16,7	21,9	25,5
15	0-15	0-15RP	PC0-15	19,7	24,7	30,5
16	0-16	0-16RP	PC0-16	19,7	25,7	30,5
19	0-19=3/4	0-19=3/4RP	PC0-19	19,6	29,6	30,5

METRIC LONG

8	0-8L	0-8LRP	PC0-8L	16,6	16,2	57,5
10	0-10L	0-10LRP	PC0-10L	16,6	18,7	57,5
12	0-12L	0-12LRP	PC0-12L	16,6	21,2	57,5
13	0-13L	0-13LRP	PC0-13L	16,6	22,5	57,5

SILVERLINE™ COVER

Read more about the plastic covers on page 21

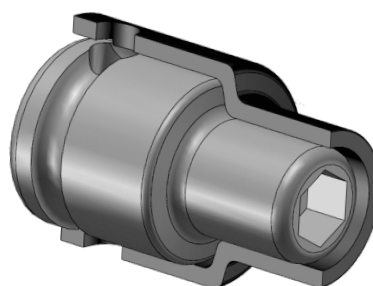

Magnetiska krafthylsor
Fast magnet

Magnetic impact sockets
Solid magnet

Magnetische Kraftsteckschlüssel
Dauermagnet

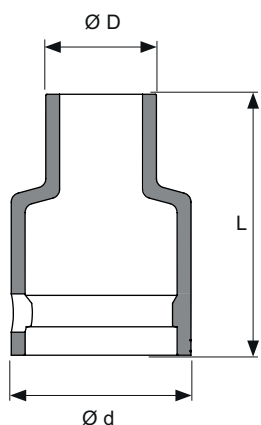

**SOLID
MAGNET**

SIZE	FITS ON SOCKET	SOCKET WITH COVER	PLASTIC COVER	Ø d	Ø D	L
<i>METRIC</i>						
6	0-6M	0-6MRP	PC0-6M	16,7	13,8	25,5
7	0-7M	0-7MRP	PC0-7M	16,7	15,1	25,5
8	0-8M	0-8MRP	PC0-8M	16,7	16,3	25,5
9	0-9M	0-9MRP	PC0-9M	16,7	17,6	25,5
10	0-10M	0-10MRP	PC0-10M	16,7	18,8	25,5
11	0-11M	0-11MRP	PC0-11M	16,7	20,1	25,5
12	0-12M	0-12MRP	PC0-12M	16,7	21,3	25,5
13	0-13M	0-13MRP	PC0-13M	16,7	21,9	25,5

<i>METRIC LONG</i>						
8	0-8ML	0-8MLRP	PC0-8ML	16,6	16,2	57,5
10	0-10ML	0-10MLRP	PC0-10ML	16,6	18,7	57,5
12	0-12ML	0-12MLRP	PC0-12ML	16,6	21,2	57,5
13	0-13ML	0-13MLRP	PC0-13ML	16,6	22,5	57,5

Magnetiska krafthylsor
Fjädrande Magnet

Magnetic impact sockets
Retracting Magnetic

Magnetische Kraftsteckschlüssel
Federndem Magnet

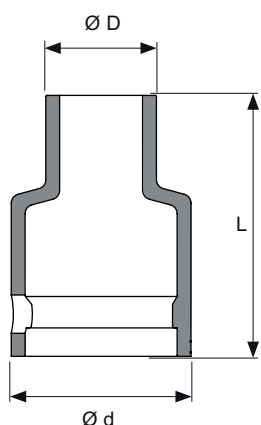

SIZE	FITS ON SOCKET	SOCKET WITH COVER	PLASTIC COVER	Ø d	Ø D	L
<i>METRIC</i>						
8	0-8RML	0-8RMLRP	PC0-8RML	16,6	16,2	57,5
10	0-10RML	0-10RMLRP	PC0-10RML	16,6	18,7	57,5
12	0-12RML	0-12RMLRP	PC0-12RML	16,6	21,2	57,5
13	0-13RML	0-13RMLRP	PC0-13RML	16,6	22,5	57,5

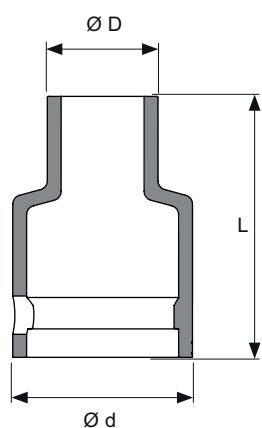

SIZE	FITS ON SOCKET	SOCKET WITH COVER	PLASTIC COVER	Ø d	Ø D	L
<i>METRIC</i>						
E5	0-E5	0-E5RP	PC0-E5	16,7	11,4	25,5
E6	0-E6	0-E6RP	PC0-E6	16,7	12,4	25,5
E7	0-E7	0-E7RP	PC0-E7	16,7	12,7	25,5
E8	0-E8	0-E8RP	PC0-E8	16,7	13,4	25,5
E10	0-E10	0-E10RP	PC0-E10	16,7	16,7	25,5

1/4"

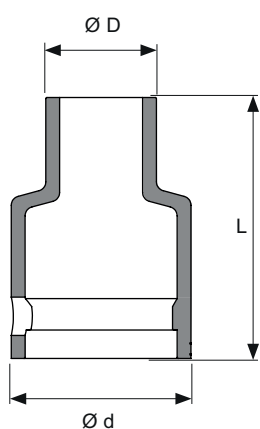

SIZE	FITS ON SOCKET	SOCKET WITH COVER	PLASTIC COVER	Ø d	Ø D	L
<i>INCH</i>						
1/4	EB00-2	EB00-2RP	PCEB00-2	17,2	12,4	43
1/4	EB00-3	EB00-3RP	PCEB00-3	17,2	12,4	68
1/4	EB00-4	EB00-4RP	PCEB00-4	17,2	12,4	94
1/4	EB00-5	EB00-5RP	PCEB00-5	17,2	12,4	119
1/4	EB00-6	EB00-6RP	PCEB00-6	17,2	12,4	145

Momento Gap Cover

Momento Gap Cover

Momento Gap Cover

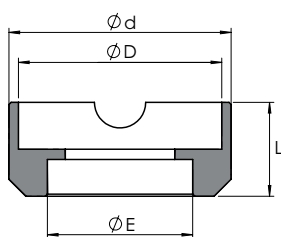

SIZE	FITS ON SOCKET	SOCKET & COVER	PLASTIC COVER	$\varnothing d$	$\varnothing D$	L	$\varnothing E$
5 - 13	0-5 > 0-13	---	PCEB00-D17	19,5	17,1	9	12,8
14 - 19	0-14 > 0-19	---	PCEB00-D20	22,5	20,1	9	12,8

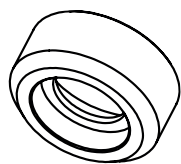

Övergångar

Adapters

Reduzierstücke

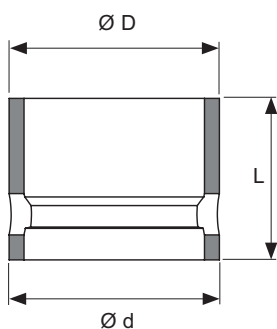

SIZE	FITS ON SOCKET	SOCKET WITH COVER	PLASTIC COVER	$\varnothing d$	$\varnothing D$	L
<i>INCH</i>						
1/4-3/8	PA01	PA01RP	PCPA01	16	16	20



3/8"



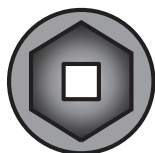
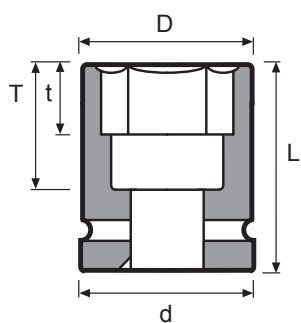

Part No	D mm	d mm	L mm	t mm	T mm	kg
1-6	10	19	33,5	4	21	0,04
1-7	12	19	33,5	5	21	0,04
1-8	13,5	19	33,5	6	21	0,04
1-9	14,8	19	33,5	6	21	0,04
1-10	16	19	33,5	7	21	0,04
1-11	17,2	19	33,5	7	21	0,04
1-12	18,5	19	33,5	8	21	0,05
1-13	19,8	22	33,5	8	21	0,06
1-14	21	22	33,5	10	21	0,06
1-15	22,5	22	33,5	10	21	0,06
1-16	23,8	22	33,5	10	21	0,06
1-17	25	22	33,5	10	21	0,08
1-18	26	22	33,5	12	21	0,08
1-19=3/4	27,5	22	33,5	12	21	0,08
1-20	28,5	22	33,5	12	21	0,10
1-21	29,5	27	33,5	14	19	0,10
1-22	31	27	33,5	14	19	0,12
1-24	33,5	27	33,5	15	19	0,12

Part No	D mm	d mm	L mm	t mm	T mm	kg
1-6L	10	19	57	4	45	0,08
1-7L	12	19	57	5	45	0,08
1-8L	13,5	19	57	5	45	0,06
1-9L	14,8	19	57	5	45	0,06
1-10L	16	19	57	7	45	0,07
1-11L	17,2	19	57	7	45	0,07
1-12L	18,5	19	57	8	45	0,07
1-13L	19,8	22	57	8	44	0,09
1-14L	21	22	57	10	44	0,10
1-15L	22,5	22	57	10	44	0,10
1-16L	23,8	22	57	10	44	0,10
1-17L	25	22	57	10	44	0,12
1-18L	26	22	57	12	44	0,13
1-19=3/4L	27,5	22	57	12	44	0,13
1-21L	29,5	27	57	14	43	0,18
1-22L	31	27	57	14	43	0,20
1-24L	33,5	27	57	15	42	0,19

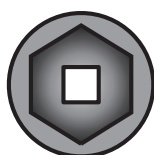
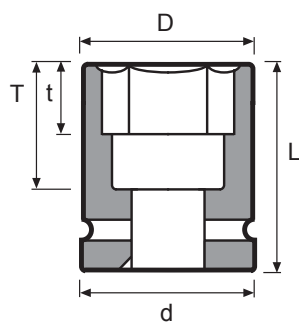

Hexagon	Part No	D mm	d mm	L mm	t mm	T mm	kg
1/8	1-1/8	6,7	19	34	3	22	0,04
1/4	1-1/4	10	19	34	4	22	0,04
5/16	1-5/16	13,5	19	34	5	22	0,04
3/8	1-3/8	16	19	34	7	22	0,04
7/16	1-7/16	17,2	19	34	7	22	0,05
1/2	1-1/2	19,8	22	34	8	22	0,06
9/16	1-9/16	21	22	34	10	22	0,06
5/8	1-5/8	23,8	22	34	10	22	0,07
11/16	1-11/16	25	22	34	10	22	0,06
3/4	1-19=3/4	27,5	22	34	11	22	0,07
13/16	1-13/16	29,5	27	34	12	19	0,10
7/8	1-7/8	31	27	34	12	19	0,12
1/4	1-1/4L	10	19	57	4	22	0,07
5/16	1-5/16L	13,5	19	57	5	22	0,07
3/8	1-3/8L	16	19	57	7	22	0,07
7/16	1-7/16L	17,2	19	57	7	22	0,07
1/2	1-1/2L	19,8	19	57	7	22	0,09
9/16	1-9/16L	21	22	57	10	22	0,08
5/8	1-5/8L	23,8	22	57	10	21	0,11
11/16	1-11/16L	25	22	57	10	21	0,13





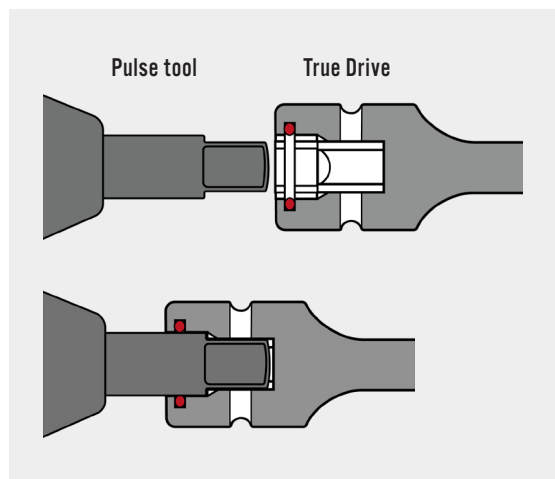

**REDUCED
VIBRATIONS**



**RISK FOR
VIBRATIONS**

 Den fördjupade drivänden på Momentos True Drive hylsor reducerar vibrationer mellan lufthydrauliska mutterdragare (pulsverktyg) och hylsan. För att ytterligare förbättra noggrannheten på det från pulsverktyget till hylsan överförda vridmomentet är True Drive hylsorna försedda med en invändig o-ring som optimerar den perfekta passningen mot pulsverktygets städ. Dessutom reduceras överföring av vibrationer till pulsverktyg och operatör.

 The deepened drive end of the Momento True Drive sockets reduces vibrations between pulse tool and the socket. An O-ring inside the True Drive socket optimizes the perfect fit on the pulse tool anvil to the effect, that the exactness of the torque given by the pulse tool is improved. Furthermore, the True Drive reduces the direct transmission of vibrations on the pulse tool and finally on the operator.

 Der vertiefte Vierkant-Antrieb der Momento True Drive-Steckschlüssel reduziert Vibrationen zwischen dem Impulswerkzeug und der Steckschlüssel. Ein im Antriebsende der True Drive-Steckschlüssel eingesetzter O-Ring optimiert den festen Sitz der Steckschlüssel auf der Schrauberspindel und sorgt somit für die unmittelbare Weitergabe des vorgegebenen Drehmomentes ohne wesentliche Drehkraftverluste.



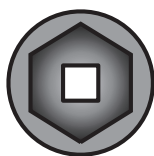
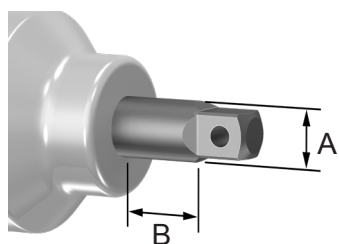
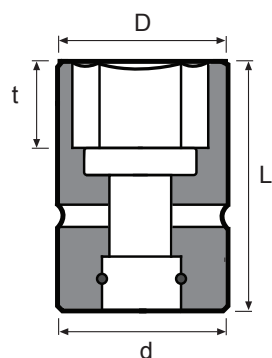

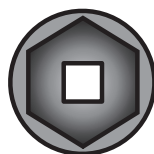
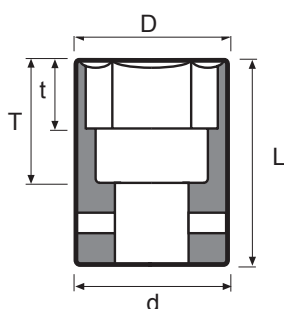

Part No	A	B (min)	D mm	d mm	L mm	t mm	kg	
8	1-8TD12	12	11	14	19	40	5	0,045
10	1-10TD12	12	11	16	19	40	7	0,05
12	1-12TD12	12	11	18,5	19	40	8	0,05
13	1-13TD12	12	11	19,8	22	40	8	0,07
14	1-14TD12	12	11	21	22	40	10	0,07
15	1-15TD12	12	11	22,5	22	40	10	0,07
16	1-16TD12	12	11	23,8	22	40	10	0,075
17	1-17TD12	12	11	25	22	40	10	0,075
18	1-18TD12	12	11	26	22	40	12	0,08
19	1-19TD12	12	11	27,5	22	40	12	0,08
8	1-8TD12L100	12	11	14	19	100	5	0,095
10	1-10TD12L100	12	11	16	19	100	7	0,10
12	1-12TD12L100	12	11	18,5	19	100	8	0,11
13	1-13TD12L100	12	11	19,8	22	100	8	0,14
14	1-14TD12L100	12	11	21	22	100	10	0,15
15	1-15TD12L100	12	11	22,5	22	100	10	0,16
16	1-16TD12L100	12	11	23,8	22	100	10	0,18
17	1-17TD12L100	12	11	25	22	100	10	0,19
8	1-8TD12L150	12	11	14	19	150	5	0,125
10	1-10TD12L150	12	11	16	19	150	7	0,13
12	1-12TD12L150	12	11	18,5	19	150	8	0,14
13	1-13TD12L150	12	11	19,8	22	150	8	0,17
14	1-14TD12L150	12	11	21	22	150	10	0,18
15	1-15TD12L150	12	11	22,5	22	150	10	0,19
16	1-16TD12L150	12	11	23,8	22	150	10	0,225
17	1-17TD12L150	12	11	25	22	150	10	0,235
8	1-8TD12L200	12	11	14	19	200	5	0,16
10	1-10TD12L200	12	11	16	19	200	7	0,16
12	1-12TD12L200	12	11	18,5	19	200	8	0,17
13	1-13TD12L200	12	11	19,8	19	200	8	0,20
14	1-14TD12L200	12	11	21	22	200	10	0,21
15	1-15TD12L200	12	11	22,5	22	200	10	0,22
16	1-16TD12L200	12	11	23,8	22	200	10	0,27
17	1-17TD12L200	12	11	25	22	200	10	0,28



Part No	D mm	d mm	L mm	t mm	T mm	kg
6 T1-6	9,5	18	33,5	4	21	0,03
7 T1-7	11	18	33,5	5	21	0,03
8 T1-8	12,2	18	33,5	6	21	0,03
9 T1-9	13,5	18	33,5	6	21	0,03
10 T1-10	14,7	18	33,5	7	21	0,03
11 T1-11	16	18	33,5	7	21	0,03
12 T1-12	17,2	18	33,5	8	21	0,03
13 T1-13	18,5	18,5	33,5	8	21	0,04
14 T1-14	19,7	19,7	33,5	10	21	0,04
15 T1-15	21	21	33,5	10	21	0,05
16 T1-16	22,2	22	33,5	10	21	0,05
17 T1-17	23,5	22	33,5	10	21	0,06
18 T1-18	24,7	22	33,5	12	21	0,06
19 T1-19=3/4	26	22	33,5	12	21	0,07
8 T1-8L	12,2	19	57	5	45	0,06
10 T1-10L	14,7	19	57	7	45	0,05
11 T1-11L	16	19	57	7	45	0,05
12 T1-12L	17,2	19	57	8	45	0,06
13 T1-13L	18,5	22	57	8	44	0,07
14 T1-14L	19,7	22	57	10	44	0,08
15 T1-15L	21	22	57	10	44	0,08
16 T1-16L	22,2	22	57	10	44	0,11
17 T1-17L	23,5	22	57	10	44	0,13
18 T1-18L	24,7	22	57	12	44	0,12
19 T1-19=3/4L	26	22	57	12	44	0,13

 Tunnväggiga hylsor har små ytterdiametrar liknande förkromade handhylsor.

De tål därför inte lika stora påfrestningar som normala krafthylsor och bör bara användas när utrymmet är begränsat.

 Thin wall sockets have small outside diameters like hand tool sockets.

They cannot be expected to stand up to the same high loads as normal impact sockets and should only be used when limited clearance is a factor.

 Dünnwandige Steckschlüssel-einsätze haben kleine Auswendurchmesser ähnlich verchromten Hand Steckschlüsseln.

Es kann nicht erwartet werden, dass sie die gleiche hohe Belastung wie normale Kraftsteckschlüssel aushalten. Sie sollten nur bei Platzmangel eingesetzt werden.

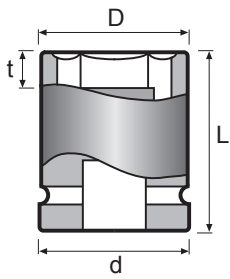

Part No	D mm	d mm	L mm	t mm	kg
7 1-7M	12	19	33,5	2,5	0,04
8 1-8M	13,5	19	33,5	3	0,05
10 1-10M	16	19	33,5	5	0,05
11 1-11M	17,2	19	33,5	5	0,05
12 1-12M	18,5	19	33,5	5	0,05
13 1-13M	19,8	22	33,5	5	0,06
14 1-14M	21	22	33,5	7	0,07
15 1-15M	22,5	22	33,5	7	0,07
16 1-16M	23,8	22	33,5	8	0,08
17 1-17M	25	22	33,5	8	0,08
18 1-18M	26	22	33,5	8	0,09
19 1-19M	27,5	22	33,5	8	0,10
8 1-8ML	13,5	19	57	3	0,07
10 1-10ML	16	19	57	5	0,08
11 1-11ML	17,2	19	57	5	0,08
12 1-12ML	18,5	19	57	5	0,08
13 1-13ML	19,8	22	57	6	0,09
14 1-14ML	21	22	57	7	0,10
15 1-15ML	22,5	22	57	7	0,10
16 1-16ML	23,8	22	57	8	0,10
17 1-17ML	25	22	57	8	0,12
18 1-18ML	26	22	57	8	0,13
19 1-19ML	27,5	22	57	8	0,13
1/4 1-1/4M	10	19	34	2,5	0,04
5/16 1-5/16M	13,5	19	34	3	0,05
3/8 1-3/8M	16	19	34	5	0,05
7/16 1-7/16M	17,2	19	34	5	0,05
1/2 1-1/2M	19,8	22	34	5	0,06
9/16 1-9/16M	21	22	34	7	0,07

11 times more powerful magnets!

We use neodym magnets. They are 11 times stronger than ferrite magnets.

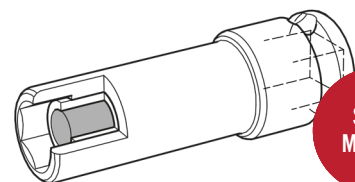
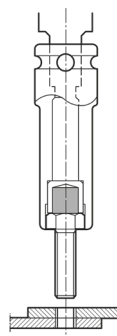

SOLID MAGNET

Magnetiska krafthylsor
Magnetring

Magnetic impact sockets
Magnetic ring

Magnetische Kraftsteckschlüssel
Magnetring

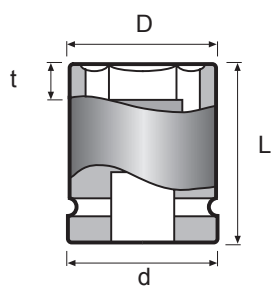

Part No	D mm	d mm	L mm	t mm	kg
8 1-8MRL	13,5	19	57	3	0,06
10 1-10MRL	16	19	57	5	0,07
12 1-12MRL	18,5	19	57	6	0,08
13 1-13MRL	19,8	22	57	6	0,10
14 1-14MRL	21	22	57	6	0,11
15 1-15MRL	22,5	22	57	7	0,12

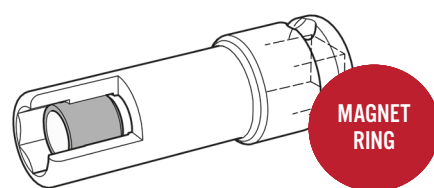
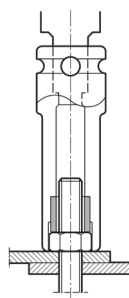
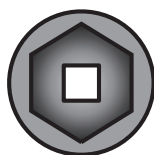

Magnetiska krafthylsor
Fjädrande magnet

Magnetic impact sockets
Retracting magnet

Magnetische Kraftsteckschlüssel
Federndem Magnet

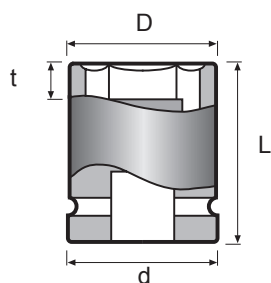

Part No	D mm	d mm	L mm	t mm	kg
8 1-8RML	13,5	19	57	3	0,06
10 1-10RML	16	19	57	5	0,07
12 1-12RML	18,5	19	57	6	0,08
13 1-13RML	19,8	22	57	6	0,10
14 1-14RML	21	22	57	6	0,11
15 1-15RML	22,5	22	57	7	0,12

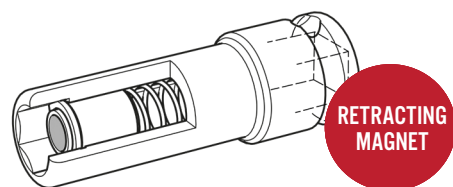
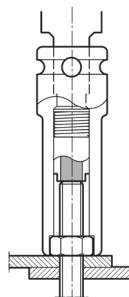
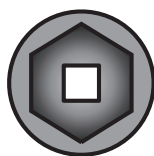



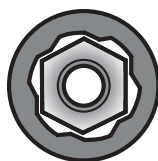
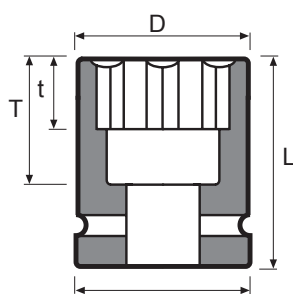

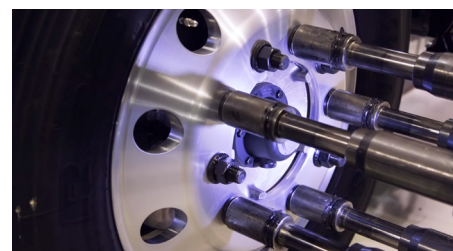

Part No	D mm	d mm	L mm	t mm	T mm	kg	
8	1-SF8	13,5	19	33,5	6	21	0,04
10	1-SF10	16	19	33,5	7	21	0,04
11	1-SF11	17,2	19	33,5	7	21	0,04
12	1-SF12	18,5	19	33,5	8	21	0,04
13	1-SF13	19,8	22	33,5	8	21	0,06
14	1-SF14	21	22	33,5	10	21	0,06
15	1-SF15	22,5	22	33,5	10	21	0,06
16	1-SF16	23,8	22	33,5	10	21	0,06
17	1-SF17	25	22	33,5	10	21	0,07
18	1-SF18	26	22	33,5	12	21	0,08
19	1-SF19=3/4	27,5	22	33,5	12	21	0,08
21	1-SF21	29,5	27	33,5	14	21	0,10
22	1-SF22	31	27	33,5	12	21	0,10
24	1-SF24	33,5	27	33,5	15	21	0,12
8	1-SF8L	13,5	19	57	5	45	0,06
10	1-SF10L	16	19	57	7	45	0,07
11	1-SF11L	17,2	19	57	7	45	0,08
12	1-SF12L	18,5	19	57	8	45	0,07
13	1-SF13L	19,8	22	57	8	45	0,10
14	1-SF14L	21	22	57	10	45	0,11
15	1-SF15L	22,5	22	57	10	45	0,10
16	1-SF16L	23,8	22	57	10	45	0,12
18	1-SF18L	26	22	57	12	45	0,14
19	1-SF19=3/4L	27,5	22	57	12	45	0,14
22	1-SF22L	31	27	57	12	43	0,20



 Surface drive hylsor är avsedda för segdragande mutterdragare. De är i första hand avsedda att underlätta hylsans äntring av skruv/mutter vid t ex montage med flerspindlig mutterdragare.

Momentos patenterade nyckelgrepp har flat kontaktyta mellan krafthylsan och muttern/skruvskallen.

 Surface drive sockets are intended for stall type nutrunners. Their primary use is to facilitate when the socket is entering the fastener, for example, mounting with a multispindle nut runner.

Momento's patented surface drive opening has flat areas of contact to the nut or bolt.

 Surface drive Steckschlüssel sind für Drehschrauber bestimmt. In erster Linie sollen sie dem Steckschlüssel die Passform der Schraube/Mutter erleichtern, wenn sie zB mit einem mehrspindel Drehschrauber montiert werden.

Die patentierte Momento Surface-Drive-Öffnung hat flache Kontaktflächen zu Muttern und Bolzen.

Six Lobe krafthylsor

Six Lobe impact sockets

Six Lobe Kraftsteckschlüssel

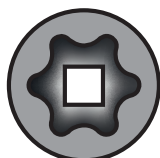
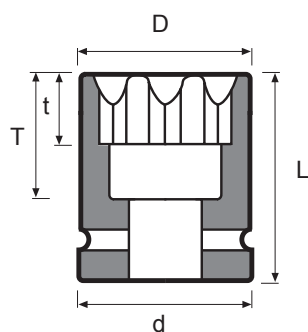

Part No	D mm	d mm	L mm	t mm	T mm	kg
E6 1-E6	10,7	19	33,5	4,5	21	0,04
E7 1-E7	11,2	19	33,5	5,5	21	0,04
E8 1-E8	11,7	19	33,5	6,5	21	0,04
E10 1-E10	12	19	33,5	7	21	0,04
E12 1-E12	14,2	19	33,5	8,5	21	0,04
E14 1-E14	17,2	19	33,5	9,5	21	0,04
E16 1-E16	18,2	19	33,5	10,5	21	0,05

- Passar till på marknaden vanligt förekommande skruvar med hexalobulärt grepp.
- Fits on the market commonly used screws with hexalobular driving feature.
- Passend zu den auf dem Markt gängigen Schrauben mit Innensechsrund Antrieb

Fyrkant krafthylsor

4-point impact sockets

Vierkant Kraftsteckschlüssel

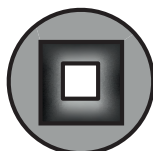
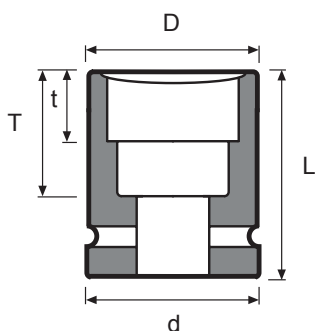

Part No	D mm	d mm	L mm	t mm	T mm	kg
5 1-4K5	14	22	34	5	22	0,06
7 1-4K7	16	22	34	7	22	0,12
8 1-4K8	18,5	22	34	8	22	0,12
10 1-4K10	22	22	34	10	22	0,12
12 1-4K12	24	22	38	12	24	0,12
14 1-4K14	27	22	40	14	26	0,12
17 1-4K17	32	22	45	17	30	0,17
1/4 1-4K1/4	15	22	34	6	22	0,12
3/8 1-4K3/8	22	22	34	10	22	0,12
1/2 1-4K1/2	36	22	38	15	22	0,11

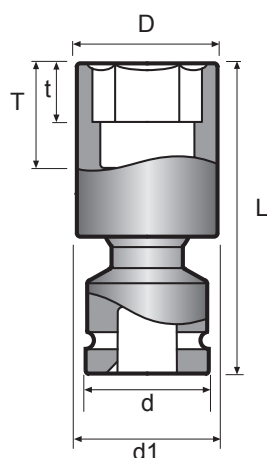

3/8"



Part No	D mm	d mm	d1 mm	L mm	t mm	T mm	kg	
10	US1-10	14,6	22	20	60	7	17	0,1
11	US1-11	15,9	22	20	60	7	17	0,1
12	US1-12	17,1	22	20	60	8	17	0,1
13	US1-13	18,4	22	22	60	8	17	0,1
14	US1-14	19,6	22	22	60	10	17	0,1
15	US1-15	20,9	22	25	60	10	17	0,11
16	US1-16	22,1	22	25	60	10	17	0,11
17	US1-17	24	22	24	60	10	14	0,12
18	US1-18	25	22	25	60	11	14	0,13
19	US1-19=3/4	26	22	26	60	11	14	0,13
10	US1-10L	14,6	22	20	150	7	17	0,15
11	US1-11L	15,9	22	20	150	7	17	0,15
12	US1-12L	17,1	22	20	150	8	17	0,15
13	US1-13L	18,4	22	22	150	8	17	0,15
14	US1-14L	19,6	22	22	150	10	17	0,15
15	US1-15L	20,9	22	25	150	10	17	0,16
16	US1-16L	22,1	22	25	150	10	17	0,18
17	US1-17L	24	22	24	150	10	14	0,19
18	US1-18L	25	22	25	150	11	14	0,19
19	US1-19L=3/4L	26	22	26	150	11	14	0,20
3/8"	US1-3/8	14,6	22	20	60	7	17	0,1
7/16"	US1-7/16	15,9	22	20	60	7	17	0,1
1/2"	US1-1/2	18,1	22	22	60	8	15	0,1
9/16"	US1-9/16	19,8	22	22	60	9	15	0,1
5/8"	US1-5/8	22,1	22	25	60	10	15	0,1
3/4"	US1-19=3/4	26	22	26	60	11	14	0,11
3/8"	US1-3/8L	14,6	22	20	150	7	7	0,15
7/16"	US1-7/16L	15,9	22	20	150	7	7	0,15
1/2"	US1-1/2L	18,1	22	22	150	8	8	0,15
9/16"	US1-9/16L	19,8	22	22	150	9	9	0,15
5/8"	US1-5/8L	22,1	22	25	150	10	10	0,19
3/4"	US1-19=3/4L	26	22	26	150	11	11	0,2

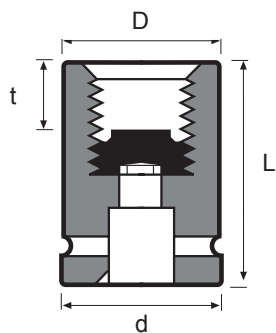

Hexagon	Part No	Stigning Pitch Steigung	D mm	d mm	L mm	t mm	kg
M4	1-M4	0,7	12	19	57	5	0,05
M5	1-M5	0,8	13,5	19	57	7	0,07
M6	1-M6	1	13,5	19	57	8	0,07
M8	1-M8	1,25	17,5	19	57	12	0,07
M10	1-M10	1,5	18,5	19	57	14	0,09
M12	1-M12	1,75	21	22	57	16	0,09
1/4" - 20 UNC	1-UNC1/4		14,8	19	57	8	0,07
5/16" - 18 UNC	1-UNC5/16		17,2	19	57	12	0,08
3/8" - 16 UNC	1-UNC3/8		18,5	19	57	14	0,09

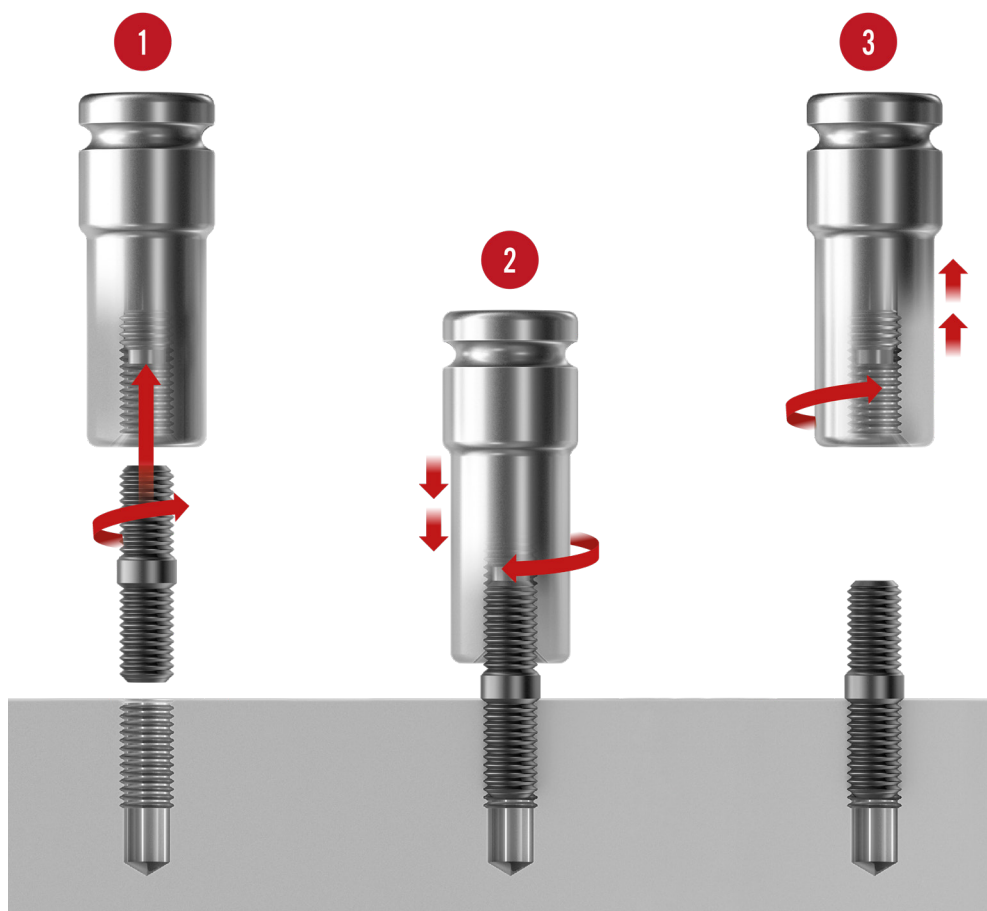

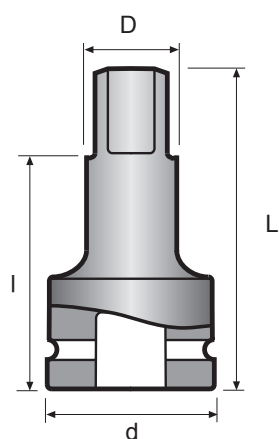

□	■	Part No	Model	D mm	d mm	L mm	l mm	kg
3/8	3/8	EB11-1 1/4	A	12,4	21,25	32	20	0,05
3/8	3/8	EB11-2	A	12,4	21,25	51	40	0,07
3/8	3/8	EB11-3	A	12,4	21,25	76	65	0,10
3/8	3/8	EB11-4	A	12,4	21,25	102	91	0,12
3/8	3/8	EB11-5	A	12,4	21,25	127	116	0,16
3/8	3/8	EB11-6	A	12,4	21,25	152	141	0,16
3/8	3/8	EB11-7	A	12,4	21,25	178	167	0,19
3/8	3/8	EB11-8	A	12,4	21,25	203	192	0,24
3/8	3/8	EB11-10	A	12,4	21,25	254	243	0,27
3/8	3/8	EB11-12	A	12,4	22	305	294	0,43
3/8	1/4	EB10-4	A	12,4	21,25	102	94,5	0,12
3/8	1/4	EB10-5	A	12,4	21,25	127	119,5	0,16
3/8	1/4	EB10-6	A	12,4	21,25	152	144,5	0,16
3/8	1/4	EB10-8	A	12,4	21,25	203	195,5	0,24

K*

A

B



 * K: Våra 1/4", 3/8", 1/2" och 5/8" förlängare kan även fås med fjädrande kula som låsning, lägg till ett "K" efter artikelnumret för utförande med kula.

 * K: Our 1/4", 3/8", 1/2" and 5/8" extensions can also be supplied with spring ball as locking, add a "K" for the part number for the version with ball.

 * K: Unsere 1/4", 3/8", 1/2" und 5/8" verlängerungen können auch mit Federkugel als Verriegelung geliefert werden. Fügen Sie ein "K" für die Teilenummer der Version mit Kugel hinzu.

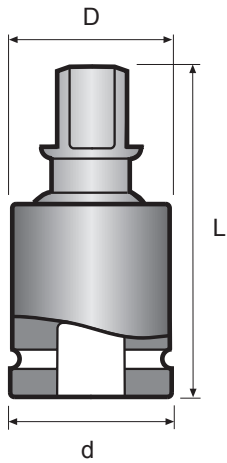

		Part No	Model	D mm	d mm	L mm	kg
3/8	3/8	UK11S	A	25	22	52	0,09
3/8	3/8	UK11-IMP*	A	30	22	58	0,14

*Heavy duty version for use with impact tool

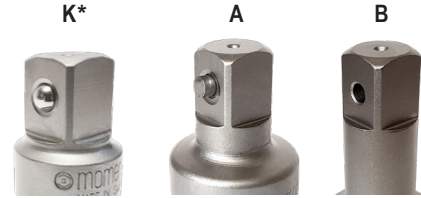

* K: Våra 1/4", 3/8", 1/2" och 5/8" universalknutar kan även fås med fjädrande kula som låsning, lägg till ett "K" efter artikelnumret för utförande med kula.

* K: Our 1/4", 3/8", 1/2" and 5/8" universal joints can also be supplied with spring ball as locking, add a "K" for the part number for the version with ball.

* K: Unsere 1/4", 3/8", 1/2" und 5/8" Universalgelenke können auch mit Federkugel als Verriegelung geliefert werden. Fügen Sie ein "K" für die Teilenummer der Version mit Kugel hinzu.



Momentos 1/4", 3/8" och 1/2" universalknutar är fjäderbelastade och kan ställas i önskad vinkel.

1/4", 3/8" and 1/2" Memento universal joints are spring loaded and can be preset at an angle.

Memento Kugelgelenke mit 1/4", 3/8" und 1/2" Vierkantantrieb sind federbelastet und auf Winkel einstellbar.

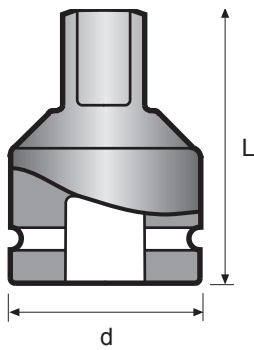

		Part No	Model	d mm	L mm	kg
3/8	1/4	PA10	A	21,25	31	0,05
3/8	1/2	PA14	A	21,25	35	0,06

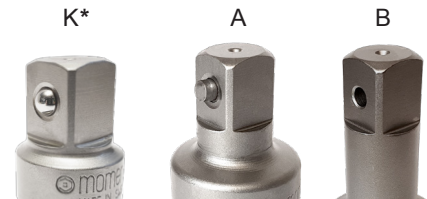

Var försiktig vid övergång till mindre fyrkant. Då mutterdragaren kan ge ett för högt vridmoment för den mindre tappen, lämnas ingen garanti.

Be careful when adapting to a smaller drive. As the power input may be too high for the smaller drive square, there is no guarantee when adapting down.

Seien Sie vorsichtig beim Übergang zu kleinen Antriebsvierkanten. Da das Drehmoment für den kleinen Vierkant zu hoch sein kann, kann keine Garantie übernommen werden.

* K: Våra 1/4", 3/8", 1/2" och 5/8" övergångar kan även fås med fjäderande kula som låsning, lägg till ett "K" efter artikelnumret för utförande med kula.

* K: Our 1/4", 3/8", 1/2" and 5/8" adapters can also be supplied with spring ball as locking, add a "K" for the part number for the version with ball.

* K: Unsere 1/4", 3/8", 1/2" und 5/8" reduzierstücke können auch mit Federkugel als Verriegelung geliefert werden. Fügen Sie ein "K" für die Teilenummer der Version mit Kugel hinzu.

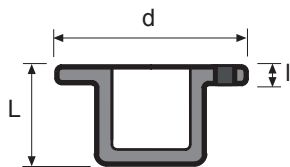
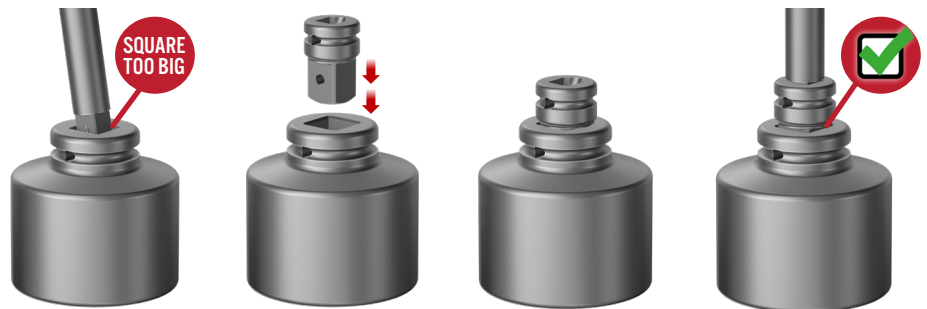

		Part No	d mm	L mm	l mm	kg
3/8	1/2	IPA14	30	18,5	3,5	0,03

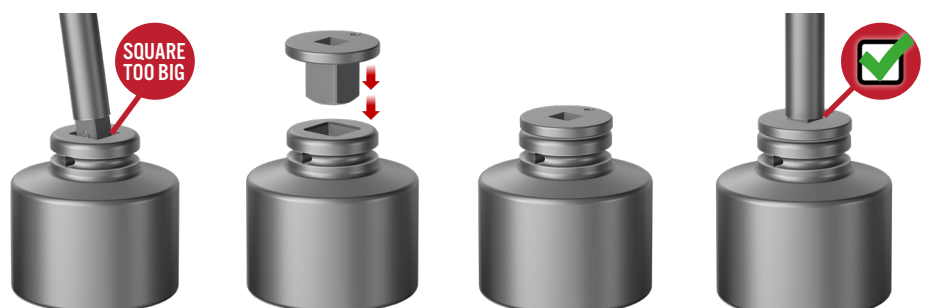

The total height

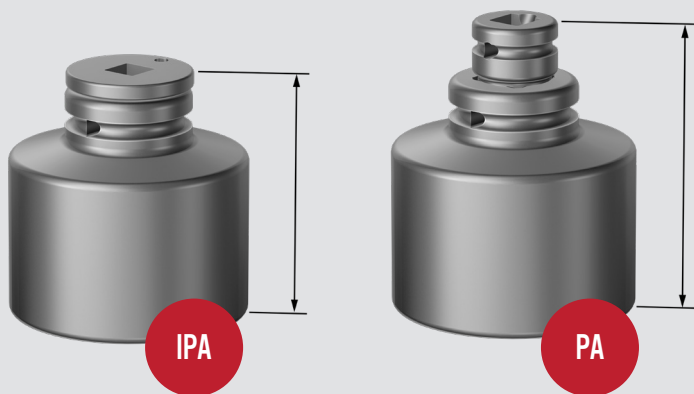

Secured with



i Info about different types of securing in the beginning of the catalog.

3/8"

The differens between IPA and PA adapters

There are some facts that you need to know to be able to pick the best adapter for your job.



- Säkras med Momento Locking, Ret ring eller Pinne och O-ring.
- Kräver större utrymme än IPA
- Secured with Momento Locking, Ret ring or Pin and O-ring.
- Requires more space than IPA
- Mit Momento Locking, Ret-Ring oder Sicherungsstifte und O-Ringe gesichert.
- Benötigt mehr Platz als IPA



- Används när utrymmet är begränsat
- Kan inte säkras med pinne och O-ring (Insatsövergången hålls kvar i hylsan med hjälp av en magnet)
- Used when space is limited
- Cannot be secured with pin and O-ring (The insert adapter sticks to the socket by means of a magnet)
- Wird verwendet, wenn der Platz begrenzt ist
- Kann nicht mit Sicherungsstifte und O-Ringe gesichert werden (Ein Magnet hält das Reduzierstück am Kraftsteckschlüssel)

Krafthylsor

Impact sockets

Kraftsteckschlüssel

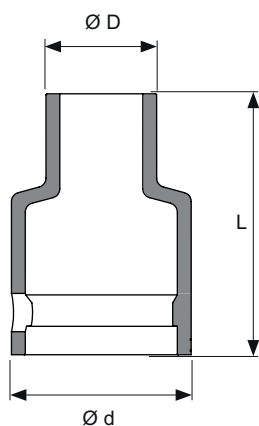

SIZE	FITS ON SOCKET	SOCKET WITH COVER	PLASTIC COVER	Ø d	Ø D	L
<i>METRIC</i>						
6	1-6	1-6RP	PC1-6	23,4	14,4	34
7	1-7	1-7RP	PC1-7	23,4	16,4	34
8	1-8	1-8RP	PC1-8	23,4	17,9	34
9	1-9	1-9RP	PC1-9	23,4	19,2	34
10	1-10	1-10RP	PC1-10	23,4	20,4	34
11	1-11	1-11RP	PC1-11	23,4	21,6	34
12	1-12	1-12RP	PC1-12	23,4	22,9	34
13	1-13	1-13RP	PC1-13	26,4	24,2	34
14	1-14	1-14RP	PC1-14	26,4	25,4	34
15	1-15	1-15RP	PC1-15	26,4	26,9	34
16	1-16	1-16RP	PC1-16	26,4	28,2	34
17	1-17	1-17RP	PC1-17	26,4	29,4	34
18	1-18	1-18RP	PC1-18	26,4	30,4	34
19	1-19=3/4	1-19=3/4RP	PC1-19	26,4	31,9	34
20	1-20	1-20RP	PC1-20	26,4	32,9	34
21	1-21	1-21RP	PC1-21	31,1	33,9	34
22	1-22	1-22RP	PC1-22	31,2	35,4	34
24	1-24	1-24RP	PC1-24	31,1	37,9	34

METRIC LONG

6	1-6L	1-6LRP	PC1-6L	23,2	14,2	57,5
7	1-7L	1-7LRP	PC1-7L	23,2	16,2	57,5
8	1-8L	1-8LRP	PC1-8L	23,2	17,7	57,5
9	1-9L	1-9LRP	PC1-9L	23,2	19	57,5
10	1-10L	1-10LRP	PC1-10L	23,4	20,4	57,5
11	1-11L	1-11LRP	PC1-11L	23,2	21,4	57,5
12	1-12L	1-12LRP	PC1-12L	23,2	22,7	57,5
13	1-13L	1-13LRP	PC1-13L	26,2	24	57,5
14	1-14L	1-14LRP	PC1-14L	26,2	25,8	57,5
15	1-15L	1-15LRP	PC1-15L	26,2	27,3	57,5
16	1-16L	1-16LRP	PC1-16L	26,2	28,6	57,5
17	1-17L	1-17LRP	PC1-17L	26,2	29,8	57,5
18	1-18L	1-18LRP	PC1-18L	26,2	30,8	57,5
19	1-19=3/4L	1-19=3/4LRP	PC1-19L	26,2	32,3	57,5
21	1-21L	1-21LRP	PC1-21L	31,2	33,9	57,5
22	1-22L	1-22LRP	PC1-22L	31,2	35,4	57,5
24	1-24L	1-24LRP	PC1-24L	31,2	37,9	57,5

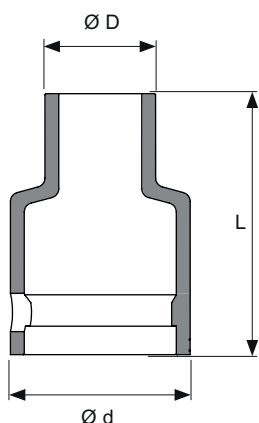

SIZE	FITS ON SOCKET	SOCKET WITH COVER	PLASTIC COVER	Ø d	Ø D	L
<i>METRIC</i>						
7	1-7M	1-7MRP	PC1-7M	23,4	16,4	34
8	1-8M	1-8MRP	PC1-8M	23,4	17,9	34
9	1-9M	1-9MRP	PC1-9M	23,4	19,2	34
10	1-10M	1-10MRP	PC1-10M	23,4	20,4	34
11	1-11M	1-11MRP	PC1-11M	23,4	21,6	34
12	1-12M	1-12MRP	PC1-12M	23,4	22,9	34
13	1-13M	1-13MRP	PC1-13M	26,4	24,2	34
14	1-14M	1-14MRP	PC1-14M	26,4	25,4	34
15	1-15M	1-15MRP	PC1-15M	26,4	26,9	34
16	1-16M	1-16MRP	PC1-16M	26,4	28,2	34
17	1-17M	1-17MRP	PC1-17M	26,4	29,4	34
18	1-18M	1-18MRP	PC1-18M	26,4	30,4	34
19	1-19=3/4M	1-19=3/4MRP	PC1-19M	26,4	31,9	34

METRIC LONG

8	1-8ML	1-8MLRP	PC1-8ML	23,4	20,4	57,5
10	1-10ML	1-10MLRP	PC1-10ML	23,4	20,4	57,5
11	1-11ML	1-11MLRP	PC1-11ML	23,2	21,4	57,5
12	1-12ML	1-12MLRP	PC1-12ML	23,2	22,7	57,5
13	1-13ML	1-13MLRP	PC1-13ML	26,2	24	57,5
14	1-14ML	1-14MLRP	PC1-14ML	26,2	25,8	57,5
15	1-15ML	1-15MLRP	PC1-15ML	26,2	27,3	57,5
16	1-16ML	1-16MLRP	PC1-16ML	26,2	28,6	57,5
17	1-17ML	1-17MLRP	PC1-17ML	26,2	29,8	57,5
18	1-18ML	1-18MLRP	PC1-18ML	26,2	30,8	57,5
19	1-19=3/4ML	1-19=3/4MLRP	PC1-19ML	26,2	32,3	57,5

SILVERLINE™ COVER

Read more about the plastic covers on page 21

Magnetiska krafthylsor
Magnetring

Magnetic impact sockets
Magnetic ring

Magnetische Kraftsteckschlüssel
Magnetring

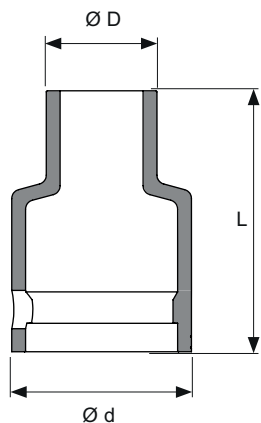

SIZE	FITS ON SOCKET	SOCKET WITH COVER	PLASTIC COVER	Ø d	Ø D	L
<i>METRIC</i>						
8	1-8MRL	1-8MRLRP	PC1-8MRL	23,4	20,4	57,5
10	1-10MRL	1-10MRLRP	PC1-10MRL	23,4	20,4	57,5
12	1-12MRL	1-12MRLRP	PC1-12MRL	23,2	22,7	57,5
13	1-13MRL	1-13MRLRP	PC1-13MRL	26,2	24	57,5
14	1-14MRL	1-14MRLRP	PC1-14MRL	26,2	25,8	57,5
15	1-15MRL	1-15MRLRP	PC1-15MRL	26,2	27,3	57,5



Magnetiska krafthylsor
Fjädrande magnet

Magnetic impact sockets
Retracting magnet

Magnetische Kraftsteckschlüssel
Federndem Magnet

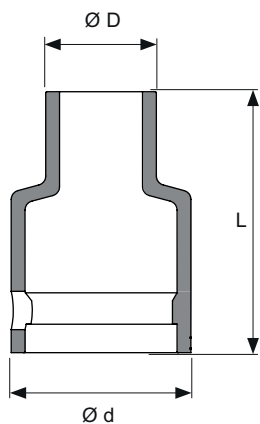

SIZE	FITS ON SOCKET	SOCKET WITH COVER	PLASTIC COVER	Ø d	Ø D	L
<i>METRIC</i>						
8	1-8RML	1-8RMLRP	PC1-8RML	23,4	20,4	57,5
10	1-10RML	1-10RMLRP	PC1-10RML	23,4	20,4	57,5
12	1-12RML	1-12RMLRP	PC1-12RML	23,2	22,7	57,5
13	1-13RML	1-13RMLRP	PC1-13RML	26,2	24	57,5
14	1-14RML	1-14RMLRP	PC1-14RML	26,2	25,8	57,5
15	1-15RML	1-15RMLRP	PC1-15RML	26,2	27,3	57,5





3/8"

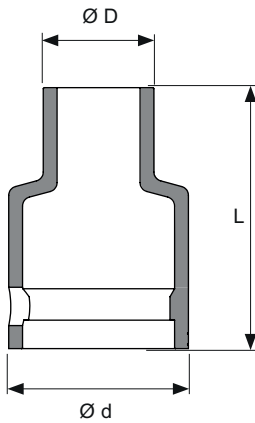

SIZE	FITS ON SOCKET	SOCKET WITH COVER	PLASTIC COVER	Ø d	Ø D	L
<i>METRIC</i>						
8	1-SF8	1-SF8RP	PC1-SF8	23,4	17,9	34
10	1-SF10	1-SF10RP	PC1-SF10	23,4	20,4	34
11	1-SF11	1-SF11RP	PC1-SF11	23,4	21,6	34
12	1-SF12	1-SF12RP	PC1-SF12	23,4	22,9	34
13	1-SF13	1-SF13RP	PC1-SF13	26,4	24,2	34
14	1-SF14	1-SF14RP	PC1-SF14	26,4	25,4	34
15	1-SF15	1-SF15RP	PC1-SF15	26,4	26,9	34
16	1-SF16	1-SF16RP	PC1-SF16	26,4	28,2	34
17	1-SF17	1-SF17RP	PC1-SF17	26,4	29,4	34
18	1-SF18	1-SF18RP	PC1-SF18	26,4	30,4	34
19	1-SF19=3/4	1-SF19=3/4RP	PC1-SF19	26,4	31,9	34
21	1-SF21	1-SF21RP	PC1-SF21	31,1	33,9	34
22	1-SF22	1-SF22RP	PC1-SF22	31,2	35,4	34
24	1-SF24	1-SF24RP	PC1-SF24	31,1	37,9	34

METRIC LONG

8	1-SF8L	1-SF8LRP	PC1-SF8L	23,2	17,7	57,5
10	1-SF10L	1-SF10LRP	PC1-SF10L	23,4	20,4	57,5
11	1-SF11L	1-SF11LRP	PC1-SF11L	23,2	21,4	57,5
12	1-SF12L	1-SF12LRP	PC1-SF12L	23,2	22,7	57,5
13	1-SF13L	1-SF13LRP	PC1-SF13L	26,2	24	57,5
14	1-SF14L	1-SF14LRP	PC1-SF14L	26,2	25,8	57,5
15	1-SF15L	1-SF15LRP	PC1-SF15L	26,2	27,3	57,5
16	1-SF16L	1-SF16LRP	PC1-SF16L	26,2	28,6	57,5
17	1-SF17L	1-SF17LRP	PC1-SF17L	26,2	29,8	57,5
18	1-SF18L	1-SF18LRP	PC1-SF18L	26,2	30,8	57,5
19	1-SF19=3/4L	1-SF19=3/4LRP	PC1-SF19L	26,2	32,3	57,5
22	1-SF22L	1-SF22LRP	PC1-SF22L	31,2	35,4	57,5



Six Lobe krafthylsor

Six Lobe impact sockets

Six Lobe Kraftsteckschlüssel

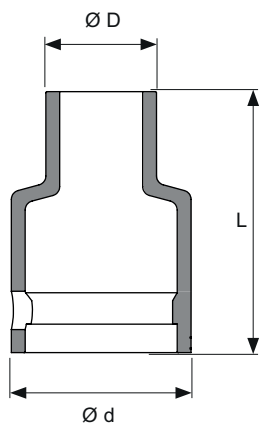

SIZE	FITS ON SOCKET	SOCKET WITH COVER	PLASTIC COVER	Ø d	Ø D	L
E6	1-E6	1-E6RP	PC1-E6	23,4	15,1	34,5
E7	1-E7	1-E7RP	PC1-E7	23,4	15,6	34,5
E8	1-E8	1-E8RP	PC1-E8	23,4	16,1	34,5
E10	1-E10	1-E10RP	PC1-E10	23,4	16,4	34,5
E12	1-E12	1-E12RP	PC1-E12	23,4	18,6	34,5
E14	1-E14	1-E14RP	PC1-E14	23,4	21,6	34,5
E16	1-E16	1-E16RP	PC1-E16	23,4	22,6	34,5



3/8"

Pinnbultshylsor

Stud runner sockets

Stehbolzensteckschlüssel

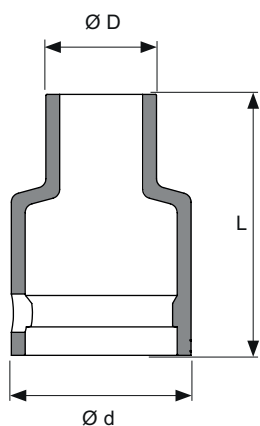

SIZE	FITS ON SOCKET	SOCKET WITH COVER	PLASTIC COVER	Ø d	Ø D	L
<i>METRIC</i>						
M4	1-M4	1-M4RP	PC1-M4	23,2	16,2	57,5
M5	1-M5	1-M5RP	PC1-M5	23,2	17,7	57,5
M6	1-M6	1-M6RP	PC1-M6	23,2	17,7	57,5
M8	1-M8	1-M8RP	PC1-M8	23,2	21,4	57,5
M10	1-M10	1-M10RP	PC1-M10	23,2	22,7	57,5
M12	1-M12	1-M12RP	PC1-M12	26,2	25,8	57,5
<i>INCH</i>						
1/4" - 20	1-UNC1/4	1-UNC1/4RP	PC1-1-UNC1/4	23,2	19	57,5
5/16" - 18	1-UNC5/16	1-UNC5/16RP	PC1-1-UNC5/16	23,2	21,4	57,5
3/8" - 16	1-UNC3/8	1-UNC3/8RP	PC1-1-UNC3/8	23,2	22,7	57,5

Förlängare

Extensions

Verlängerungen

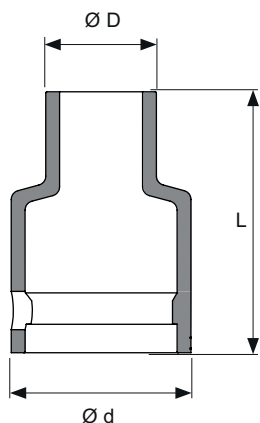

SIZE	FITS ON SOCKET	SOCKET WITH COVER	PLASTIC COVER	Ø d	Ø D	L
<i>INCH</i>						
3/8	EB11-1 1/4	EB11-1 1/4RP	PCEB11-1 1/4	25,4	25,4	20
3/8	EB11-2	EB11-2RP	PCEB11-2	25,4	16,6	39,5
3/8	EB11-3	EB11-3RP	PCEB11-3	25,4	16,6	64,5
3/8	EB11-4	EB11-4RP	PCEB11-4	25,4	16,6	90,5
3/8	EB11-5	EB11-5RP	PCEB11-5	25,4	16,6	115,5
3/8	EB11-6	EB11-6RP	PCEB11-6	25,4	16,6	140,5
3/8	EB11-7	EB11-7RP	PCEB11-7	25,4	16,6	166
3/8	EB11-8	EB11-8RP	PCEB11-8	25,4	16,6	191
3/8	EB11-10	EB11-10RP	PCEB11-10	25,4	16,6	242
3/8	EB11-12	EB11-12RP	PCEB11-12	25,4	16,6	293



Övergångar

Adapters

Reduzierstücke

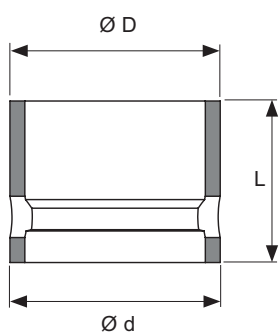

SIZE	FITS ON SOCKET	SOCKET WITH COVER	PLASTIC COVER	Ø d	Ø D	L
<i>INCH</i>						
3/8-1/4	PA10	PA10RP	PCPA10	25,4	25,4	19,5
3/8-1/2	PA14	PA14RP	PCPA14	25,4	25,4	19,5



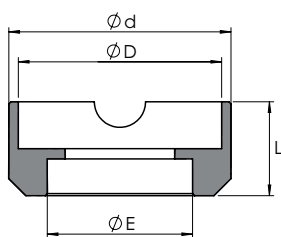

SIZE	FITS ON SOCKET	SOCKET WITH COVER	PLASTIC COVER	Ø d	Ø D	L
6 - 12	1-6 > 1-12	---	PCEB11-D24	26	23,8	11
13 - 20	1-13 > 1-20	---	PCEB11-D27	29	26,8	11
21 - 30	1-21 > 1-30	---	PCEB11-D32	34	31,8	11

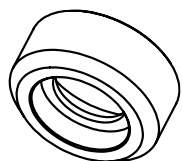

WITHOUT GAP COVER

WITH GAP COVER

1/2"



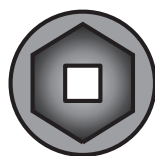
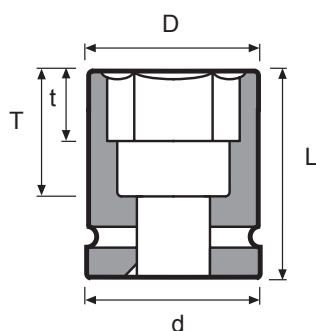

Part No	D mm	d mm	L mm	t mm	T mm	kg	
8	4-8	14,5	25	38	5	22	0,08
10	4-10	17	25	38	7	22	0,08
11	4-11	18,5	25	38	7	22	0,08
12	4-12	19,7	25	38	8	22	0,08
13	4-13	21	25	38	8	22	0,09
14	4-14	22,5	25	38	10	22	0,08
15	4-15	23,5	30	38	10	20	0,13
16	4-16	24,5	30	38	10	20	0,13
17	4-17	26	30	38	10	20	0,13
18	4-18	27,5	30	38	11	20	0,13
19	4-19=3/4	29	30	38	11	20	0,13
20	4-20	30	30	38	12	20	0,13
21	4-21	31	30	38	12	20	0,13
22	4-22	32,5	30	38	12	20	0,14
23	4-23	33,5	30	38	13	20	0,14
24	4-24	35	30	40	14	21	0,16
25	4-25	37	30	40	14	22	0,18
26	4-26	38	30	40	15	21	0,18
27	4-27=1 1/16	38,5	30	45	16	25	0,21
28	4-28	40	30	45	16	25	0,21
29	4-29	41	30	45	17	25	0,19
30	4-30=1 3/16	42,5	30	50	17	30	0,27
31	4-31	44	40	50	17	30	0,33
32	4-32	45	40	50	19	30	0,35
33	4-33	46,5	40	50	19	31	0,35
34	4-34	47	40	50	20	29	0,36
35	4-35=1 3/8	49	40	56	20	35	0,45
36	4-36	50	40	56	20	35	0,47
37	4-37	51	40	56	21	35	0,50
38	4-38=1 1/2	52	40	56	21	34	0,48
41	4-41	57	40	65	23	42	0,69
46	4-46=1 13/16	63	40	65	25	42	0,78

**Can't find what
you're looking for?**

We can manufacture
special tools to meet your
individual requirements.

Contact us and we
will help you!

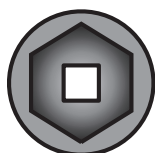
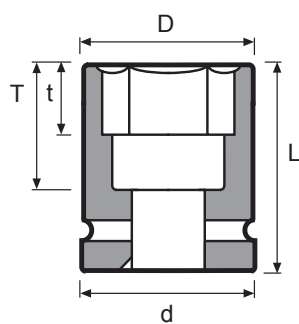

Part No	D mm	d mm	L mm	t mm	T mm	kg	
10	4-10L	17	25	82	7	64	0,14
11	4-11L	18,5	25	82	7	64	0,15
12	4-12L	19,7	25	82	8	64	0,16
13	4-13L	21	25	82	8	64	0,17
14	4-14L	22,5	25	82	10	64	0,19
15	4-15L	23,5	30	82	10	64	0,24
16	4-16L	24,5	30	82	10	64	0,22
17	4-17L	26	30	82	10	64	0,24
18	4-18L	27,5	30	82	11	64	0,26
19	4-19=3/4L	29	30	82	11	64	0,28
20	4-20L	30	30	82	12	64	0,31
21	4-21L	31	30	82	12	64	0,31
22	4-22L	32,5	30	82	12	63	0,30
23	4-23L	33,5	30	82	13	63	0,33
24	4-24L	35	30	82	14	63	0,35
25	4-25L	37	30	82	14	64	0,35
26	4-26L	38	30	82	15	63	0,43
27	4-27=1 1/16L	38,5	30	82	16	63	0,43
28	4-28L	40	30	82	16	63	0,45
29	4-29L	41	30	82	17	62	0,46
30	4-30=1 3/16L	42,5	30	82	17	63	0,52
31	4-31L	44	40	82	17	62	0,56
32	4-32L	45	40	82	19	60	0,60
33	4-33L	46,5	40	82	19	62	0,65
34	4-34L	47	40	82	20	61	0,65
35	4-35=1 3/8L	49	40	82	20	61	0,72
36	4-36L	50	40	82	20	61	0,74
38	4-38=1 1/2L	52	40	82	21	60	0,75
41	4-41L	57	40	82	23	60	0,92
46	4-46=1 13/16L	63	40	82	25	59	0,98

Need another size?

We can manufacture special tools to meet your individual requirements. Contact us and we will help you!

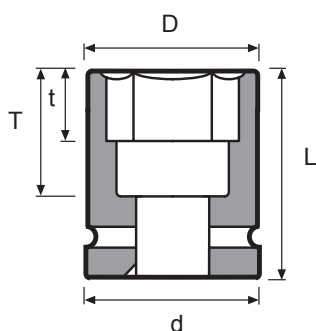

Part No	D mm	d mm	L mm	t mm	T mm	kg
1/4 4-1/4	12	25	38	4	22	0,06
5/16 4-5/16	14,5	25	38	5	22	0,07
3/8 4-3/8	17	25	38	7	20	0,08
7/16 4-7/16	18,5	25	38	7	20	0,08
1/2 4-1/2	21	25	38	8	20	0,08
9/16 4-9/16	22,5	25	38	10	20	0,08
5/8 4-5/8	24,5	30	38	10	20	0,13
11/16 4-11/16	26	30	38	10	20	0,13
3/4 4-19=3/4	29	30	38	11	20	0,13
13/16 4-13/16	31	30	38	12	20	0,13
7/8 4-7/8	32,5	30	38	12	20	0,14
15/16 4-15/16	35	30	40	14	21	0,16
1 4-1	37	30	40	14	21	0,17
1 1/16 4-27=1 1/16	38,5	30	45	16	25	0,21
1 1/8 4-1 1/8	41	30	45	17	25	0,22
1 3/16 4-30=1 3/16	42,5	30	50	17	30	0,27
1 1/4 4-1 1/4	45	40	50	19	30	0,35
1 5/16 4-1 5/16	46,5	40	50	19	30	0,29
1 7/16 4-1 7/16	51	40	56	21	35	0,51
3/8 4-3/8L	17	25	82	7	64	0,13
7/16 4-7/16L	18,5	25	82	7	64	0,15
1/2 4-1/2L	21	25	82	8	64	0,17
9/16 4-9/16L	22,5	25	82	10	64	0,19
5/8 4-5/8L	24,5	30	82	10	64	0,22
11/16 4-11/16L	26	30	82	10	64	0,24
3/4 4-19=3/4L	29	30	82	11	64	0,28
13/16 4-13/16L	31	30	82	12	64	0,31
7/8 4-7/8L	32,5	30	82	12	63	0,31
15/16 4-15/16L	35	30	82	14	63	0,35
1 4-1L	37	30	82	14	63	0,37
1 1/16 4-27=1 1/16L	38,5	30	82	16	62	0,43
1 1/8 4-1 1/8L	41	30	82	17	62	0,45
1 3/16 4-30=1 3/16L	42,5	30	82	17	62	0,48
1 1/4 4-1 1/4L	45	40	82	19	62	0,51
1 5/16 4-1 5/16L	46,5	40	82	19	62	0,59



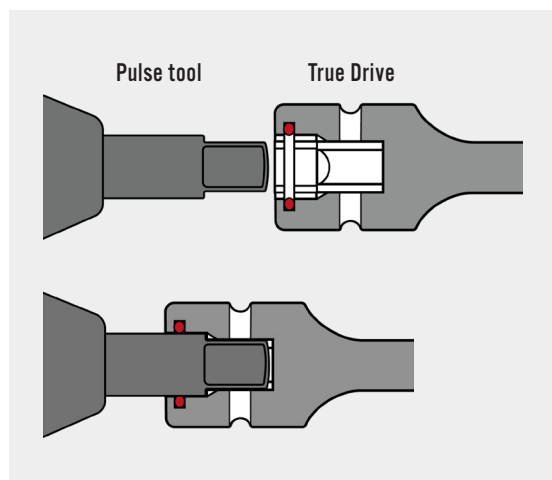

TRUE DRIVE

REDUCED
VIBRATIONS

NOT TRUE DRIVE

RISK FOR
VIBRATIONS

 Den fördjupade drivänden på Momentos True Drive hylsor reducerar vibrationer mellan lufthydrauliska mutterdragare (pulsverktyg) och hylsan. För att ytterligare förbättra noggrannheten på det från pulsverktyget till hylsan överförda vridmomentet är True Drive hylsorna försedda med en invändig o-ring som optimerar den perfekta passningen mot pulsverktygets städ. Dessutom reduceras överföring av vibrationer till pulsverktyg och operatör.

 The deepened drive end of the Momento True Drive sockets reduces vibrations between pulse tool and the socket. An O-ring inside the True Drive socket optimizes the perfect fit on the pulse tool anvil to the effect, that the exactness of the torque given by the pulse tool is improved. Furthermore, the True Drive reduces the direct transmission of vibrations on the pulse tool and finally on the operator.

 Der vertiefte Vierkant-Antrieb der Momento True Drive-Steckschlüssel reduziert Vibrationen zwischen dem Impulswerkzeug und der Steckschlüssel. Ein im Antriebsende der True Drive-Steckschlüssel eingesetzter O-Ring optimiert den festen Sitz der Steckschlüssel auf der Schrauberspindel und sorgt somit für die unmittelbare Weitergabe des vorgegebenen Drehmomentes ohne wesentliche Drehkraftverluste.



1/2"

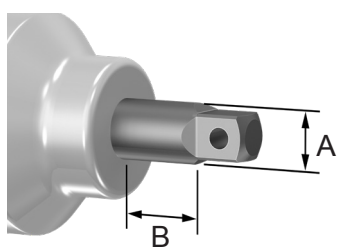
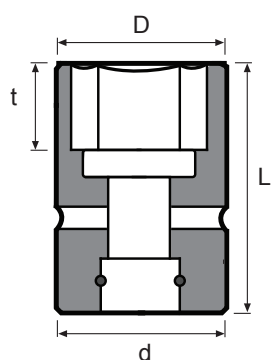

Part No	A	B (min)	D mm	d mm	L mm	t mm	kg	
12	4-12TD16L50	16	11	19,7	25	50	8	0,12
13	4-13TD16L50	16	11	21	25	50	8	0,12
14	4-14TD16L50	16	11	22,5	25	50	10	0,12
15	4-15TD16L50	16	11	23,5	30	50	10	0,18
16	4-16TD16L50	16	11	24,5	30	50	10	0,18
17	4-17TD16L50	16	11	26	30	50	10	0,18
18	4-18TD16L50	16	11	27,5	30	50	11	0,18
19	4-19TD16L50	16	11	29	30	50	12	0,18
12	4-12TD16L100	16	11	19,7	25	100	8	0,18
13	4-13TD16L100	16	11	21	25	100	8	0,19
14	4-14TD16L100	16	11	22,5	25	100	10	0,20
15	4-15TD16L100	16	11	23,5	25	100	10	0,21
16	4-16TD16L100	16	11	24,5	25	100	10	0,21
17	4-17TD16L100	16	11	26	25	100	10	0,22
18	4-18TD16L100	16	11	27,5	25	100	11	0,25
19	4-19TD16L100	16	11	29	25	100	12	0,27
12	4-12TD16L150	16	11	19,7	25	150	8	0,22
13	4-13TD16L150	16	11	21	25	150	8	0,23
14	4-14TD16L150	16	11	22,5	25	150	10	0,24
15	4-15TD16L150	16	11	23,5	25	150	10	0,25
16	4-16TD16L150	16	11	24,5	25	150	10	0,25
17	4-17TD16L150	16	11	26	25	150	10	0,26
18	4-18TD16L150	16	11	27,5	25	150	11	0,29
19	4-19TD16L150	16	11	29	25	150	12	0,34
12	4-12TD16L200	16	11	19,7	25	200	8	0,27
13	4-13TD16L200	16	11	21	25	200	8	0,27
14	4-14TD16L200	16	11	22,5	25	200	10	0,28
15	4-15TD16L200	16	11	23,5	25	200	10	0,29
16	4-16TD16L200	16	11	24,5	25	200	10	0,30
17	4-17TD16L200	16	11	26	25	200	10	0,30
18	4-18TD16L200	16	11	27,5	25	200	11	0,34
19	4-19TD16L200	16	11	29	25	200	12	0,41

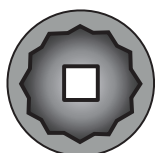
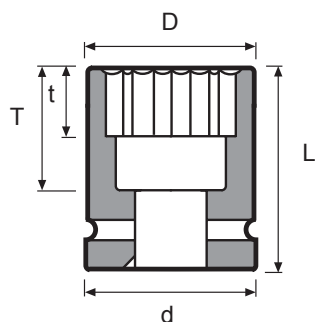

Part No	D mm	d mm	L mm	t mm	T mm	kg	
10	4-D6K10	17	25	38	7	22	0,08
11	4-D6K11	18,5	25	38	7	22	0,08
12	4-D6K12	19,7	25	38	8	22	0,08
13	4-D6K13	21	25	38	8	22	0,08
14	4-D6K14	22,5	25	38	10	22	0,08
15	4-D6K15	23,5	30	38	10	20	0,09
16	4-D6K16	24,5	30	38	10	20	0,13
17	4-D6K17	26	30	38	10	20	0,13
18	4-D6K18	27,5	30	38	11	20	0,13
19	4-D6K19=3/4	29	30	38	11	20	0,13
20	4-D6K20	30	30	38	12	20	0,13
21	4-D6K21	31	30	38	12	20	0,12
22	4-D6K22	32,5	30	38	12	20	0,14
24	4-D6K24	35	30	40	14	21	0,16
27	4-D6K27=1 1/16	38,5	30	45	16	25	0,21
30	4-D6K30=1 3/16	42,5	30	50	17	30	0,27
32	4-D6K32	45	40	50	19	30	0,35
36	4-D6K36	50	40	56	20	30	0,45
3/8	4-D6K3/8	17	25	38	7	20	0,08
7/16	4-D6K7/16	18,5	25	38	7	20	0,08
1/2	4-D6K1/2	21	25	38	8	20	0,08
9/16	4-D6K9/16	22,5	25	38	10	20	0,08
5/8	4-D6K5/8	24,5	30	38	10	20	0,13
11/16	4-D6K11/16	26	30	38	10	20	0,13
3/7	4-D6K19=3/4	29	30	38	11	20	0,13
13/16	4-D6K13/16	31	30	38	12	20	0,13
7/8	4-D6K7/8	32,5	30	38	12	20	0,13
15/16	4-D6K15/16	35	30	40	14	21	0,16
1	4-D6K1	37	30	40	14	21	0,17
1 1/16	4-D6K27=1 1/16	38,5	30	45	16	25	0,21
1 1/8	4-D6K1 1/8	41	30	45	17	25	0,22
1 3/16	4-D6K30=1 3/16	42,5	30	50	17	30	0,27
1 1/4	4-D6K1 1/4	45	40	50	19	30	0,35

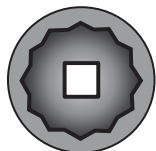
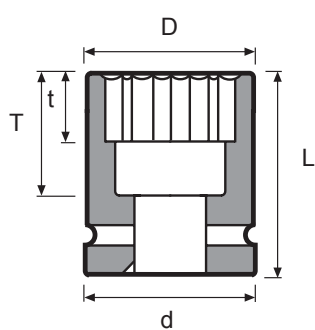

Part No	D mm	d mm	L mm	t mm	T mm	kg
10 4-D6K10L	17	25	82	7	64	0,14
11 4-D6K11L	18,5	25	82	7	64	0,15
12 4-D6K12L	19,7	25	82	8	64	0,16
13 4-D6K13L	21	25	82	8	64	0,17
14 4-D6K14L	22,5	25	82	10	64	0,19
15 4-D6K15L	23,5	30	82	10	64	0,24
16 4-D6K16L	24,5	30	82	10	64	0,22
17 4-D6K17L	26	30	82	10	64	0,24
18 4-D6K18L	27,5	30	82	11	64	0,26
19 4-D6K19=3/4L	29	30	82	11	64	0,28
21 4-D6K21L	31	30	82	12	64	0,31
22 4-D6K22L	32,5	30	82	12	63	0,30
24 4-D6K24L	35	30	82	14	63	0,35
27 4-D6K27=1 1/16L	38,5	30	82	16	63	0,42
30 4-D6K30=1 3/16L	42,5	30	82	17	63	0,52
32 4-D6K32L	45	40	82	19	60	0,60
36 4-D6K36L	50	40	82	20	61	0,74



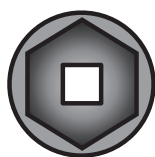
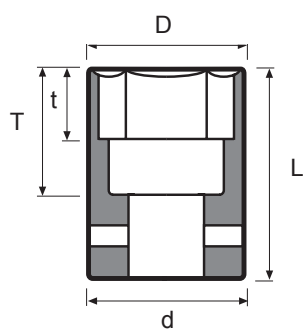

Part No	D mm	d mm	L mm	t mm	T mm	kg	
8	T4-8	13	22,5	38	5	20	0,05
10	T4-10	15,5	22,5	38	7	20	0,06
11	T4-11	16,7	22,5	38	7	20	0,05
12	T4-12	18	22,5	38	8	20	0,05
13	T4-13	19,2	22,5	38	8	20	0,06
14	T4-14	20,5	22,5	38	10	20	0,06
15	T4-15	21,7	22,5	38	10	20	0,06
16	T4-16	23	23	38	10	20	0,06
17	T4-17	24,2	24,2	38	10	20	0,07
18	T4-18	25,5	25,5	38	11	20	0,08
19	T4-19=3/4	26,7	26,7	38	11	20	0,09
20	T4-20	28	27,9	38	12	20	0,10
21	T4-21	29,2	29,2	38	12	20	0,11
22	T4-22	30,5	30,5	38	12	20	0,12
23	T4-23	31,8	31,8	38	13	20	0,13
24	T4-24	33	30	40	14	21	0,14
25	T4-25	34,2	30	40	14	21	0,16
26	T4-26	35	30	40	15	21	0,16
27	T4-27=1 1/16	36,7	30	45	16	25	0,16
28	T4-28	37,9	30	45	16	25	0,17
29	T4-29	39,3	32	45	17	25	0,19
30	T4-30=1 3/16	40,5	30	50	17	30	0,24
32	T4-32	43	40	50	19	30	0,24
33	T4-33	44,2	40	50	19	30	0,27
34	T4-34	45,5	40	50	20	29	0,25
36	T4-36	48	40	56	20	35	0,31

 Tunnväggiga krafthylsor har små ytterdiametrar liknande förkromade standardhylsor.

De tål därför inte lika stora påfrestningar som normala krafthylsor och bör bara användas när utrymmet är begränsat.

 Thin wall power sockets have small outside diameters like hand tool sockets.

They cannot be expected to stand up to the same high loads as normal impact sockets and should only be used when limited clearance is a factor.

 Dünnwandige Kraftsteckschlüsseleinsätze haben kleine Aussendurchmesser ähnlich verchromten Standardsteckschlüsseln.

Es kann nicht erwartet werden, dass sie die gleiche hohe Belastung wie normale Kraftsteckschlüssel aushalten. Sie sollten nur bei Platzmangel eingesetzt werden.

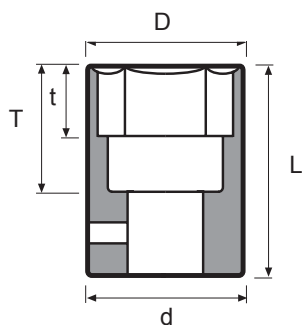

Part No	D mm	d mm	L mm	t mm	T mm	kg	
10	T4-10L	15,5	25	82	7	64	0,09
11	T4-11L	16,7	25	82	7	64	0,09
12	T4-12L	18	25	82	8	64	0,10
13	T4-13L	19,2	25	82	8	64	0,15
14	T4-14L	20,5	25	82	10	64	0,18
15	T4-15L	21,7	30	82	10	64	0,13
16	T4-16L	23	30	82	10	64	0,14
17	T4-17L	24,2	30	82	10	64	0,24
18	T4-18L	25,5	30	82	11	64	0,26
19	T4-19=3/4L	26,7	30	82	11	64	0,25
20	T4-20L	28	30	82	12	64	0,27
21	T4-21L	29,2	30	82	12	64	0,19
22	T4-22L	30,5	30	82	12	63	0,29
23	T4-23L	31,7	30	82	13	63	0,28
24	T4-24L	33	30	82	14	63	0,28
27	T4-27=1 1/16L	36,7	30	82	16	63	0,38
28	T4-28L	38	30	82	16	63	0,43
30	T4-30=1 3/16L	40,5	30	82	17	63	0,44
32	T4-32L	43	40	82	19	60	0,46
34	T4-34L	45,5	40	82	20	61	0,42
36	T4-36L	48	40	82	20	61	0,42



Tunnväggiga hylsor har små ytterdiametrar liknande förkromade handhylsor.

De tål därför inte lika stora påfrestningar som normala krafthylsor och bör bara användas när utrymmet är begränsat.



Thin wall sockets have small outside diameters like hand tool sockets.

They cannot be expected to stand up to the same high loads as normal impact sockets and should only be used when limited clearance is a factor.



Dünnwandige Steckschlüssel-einsätze haben kleine Auswendurchmesser ähnlich verchromten Hand Steckschlüsseln.

Es kann nicht erwartet werden, dass sie die gleiche hohe Belastung wie normale Kraftsteckschlüssel aushalten. Sie sollten nur bei Platzmangel eingesetzt werden.

Need another size?

We can manufacture special tools to meet your individual requirements. Contact us and we will help you!

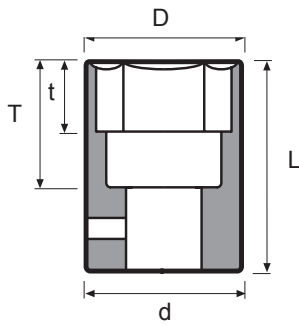

Part No	D mm	d mm	L mm	t mm	T mm	kg
3/8 T4-3/8	15,1	22,5	38	7	20	0,05
7/16 T4-7/16	16,7	22,5	38	7	20	0,05
1/2 T4-1/2	19,2	22,5	38	8	20	0,06
9/16 T4-9/16	20,9	22,5	38	10	20	0,06
5/8 T4-5/8	23	23	38	10	20	0,06
11/16 T4-11/16	24,8	24,8	38	10	20	0,08
3/4 T4-19=3/4	26,7	26,7	38	11	20	0,09
13/16 T4-13/16	28,7	28,7	38	12	20	0,11
7/8 T4-7/8	30,8	30,8	38	12	20	0,14
15/16 T4-15/16	33	30	40	14	21	0,14
1 1/16 T4-27=1 1/16	36,7	30	45	16	25	0,16
1 1/8 T4-1 1/8	38,7	30	45	17	25	0,19
1 3/16 T4-30=1 3/16	40,5	32	50	17	30	0,24
1 1/4 T4-1 1/4	43	32	50	19	30	0,29
1/2 T4-1/2L	19,2	25	82	8	64	0,22
9/16 T4-9/16L	20,5	25	82	10	64	0,22
3/4 T4-19=3/4L	26,7	30	82	11	64	0,25
13/16 T4-13/16L	29,2	30	82	12	64	0,22
1 1/16 T4-27=1 1/16L	36,7	30	82	16	62	0,38
1 3/16 T4-30=1 3/16L	40,5	30	82	17	62	0,44

 Tunnväggiga hylsor har små ytterdiametrar liknande förkromade handhylsor.

De tål därför inte lika stora påfrestningar som normala krafthylsor och bör bara användas när utrymmet är begränsat.

 Thin wall sockets have small outside diameters like hand tool sockets.

They cannot be expected to stand up to the same high loads as normal impact sockets and should only be used when limited clearance is a factor.

 Dünnwandige Steckschlüssel-einsätze haben kleine Auswendurchmesser ähnlich verchromten Hand Steckschlüsseln.

Es kann nicht erwartet werden, dass sie die gleiche hohe Belastung wie normale Kraftsteckschlüssel aushalten. Sie sollten nur bei Platzmangel eingesetzt werden.





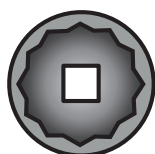
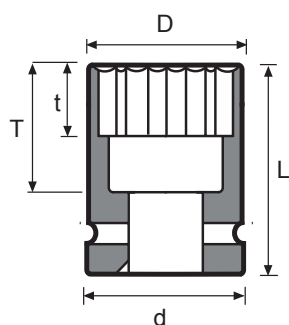



Part No	D mm	d mm	L mm	t mm	T mm	kg	
10	T4-D6K10	15,5	22,5	38	7	20	0,05
11	T4-D6K11	16,7	22,5	38	7	20	0,05
12	T4-D6K12	18	22,5	38	8	20	0,05
13	T4-D6K13	19,2	22,5	38	8	20	0,05
14	T4-D6K14	20,5	22,5	38	10	20	0,06
15	T4-D6K15	21,7	22,5	38	10	20	0,06
16	T4-D6K16	23	23	38	10	20	0,06
17	T4-D6K17	24,2	24,2	38	10	20	0,07
18	T4-D6K18	25,5	25,5	38	11	20	0,08
19	T4-D6K19=3/4	26,7	26,7	38	11	20	0,09
20	T4-D6K20	28	27,9	38	12	20	0,10
21	T4-D6K21	29,2	29,2	38	12	20	0,11
22	T4-D6K22	30,5	30,5	38	12	20	0,13
24	T4-D6K24	33	30	40	14	21	0,13
27	T4-D6K27=1 1/16	36,7	30	45	16	25	0,16
30	T4-D6K30=1 3/16	40,5	30	50	17	30	0,21
32	T4-D6K32	43	30	50	19	30	0,23

 Tunnväggiga hylsor har små ytterdiametrar liknande förkromade handhylsor.

De tål därför inte lika stora påfrestningar som normala krafthylsor och bör bara användas när utrymmet är begränsat.

 Thin wall sockets have small outside diameters like hand tool sockets.

They cannot be expected to stand up to the same high loads as normal impact sockets and should only be used when limited clearance is a factor.

 Dünnwandige Steck-schlüss-eleinsätze haben kleine Aus-sendurchmesser ähnlich verch-romten Hand Steckschlüsseln.



Es kann nicht erwartet wer-den, dass sie die gleiche hohe Belastung wie normale Kraftsteckschlüssel aushalten. Sie sollten nur bei Platzmangel eingesetzt werden.

Can't find what you're looking for?

We can manufacture special tools to meet your individual requirements.

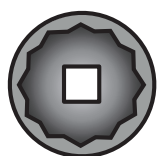
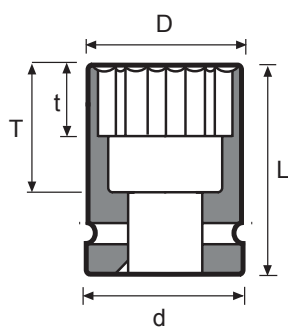
Contact us and we will help you!



		Part No	D mm	d mm	L mm	t mm	T mm	 kg
10		T4-D6K10L	15,5	25	82	7	64	0,11
11		T4-D6K11L	16,7	25	82	7	64	0,11
12		T4-D6K12L	18	25	82	8	64	0,11
13		T4-D6K13L	19,2	25	82	8	64	0,11
14		T4-D6K14L	20,5	25	82	10	64	0,12
15		T4-D6K15L	21,7	30	82	10	64	0,13
16		T4-D6K16L	23	30	82	10	64	0,14
17		T4-D6K17L	24,2	30	82	10	64	0,15
18		T4-D6K18L	25,5	30	82	11	64	0,17
19		T4-D6K19=3/4L	26,7	30	82	11	64	0,20
21		T4-D6K21L	29,2	30	82	12	64	0,23
22		T4-D6K22L	30,5	30	82	12	63	0,25
24		T4-D6K24L	33	30	82	14	63	0,27



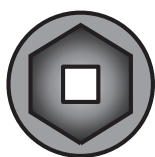
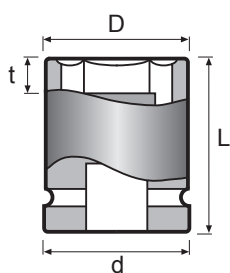

Part No	D mm	d mm	L mm	t mm	kg
10 4-10M	17	25	38	5	0,09
12 4-12M	19,7	25	38	5	0,09
13 4-13M	21	25	38	6	0,10
14 4-14M	22,5	25	38	7	0,10
15 4-15M	23,5	30	38	7	0,15
16 4-16M	24,5	30	38	8	0,15
17 4-17M	26	30	38	8	0,15
18 4-18M	27,5	30	38	8	0,15
19 4-19=3/4M	29	30	38	8	0,15
21 4-21M	31	30	38	9	0,16
22 4-22M	32,5	30	38	9	0,17
24 4-24M	35	30	40	10	0,19
10 4-10ML	17	25	82	5	0,14
12 4-12ML	19,7	25	82	5	0,16
13 4-13ML	21	25	82	6	0,17
14 4-14ML	22,5	25	82	7	0,19
15 4-15ML	23,5	30	82	7	0,24
16 4-16ML	24,5	30	82	8	0,22
17 4-17ML	26	30	82	8	0,24
18 4-18ML	27,5	30	82	8	0,26
19 4-19=3/4ML	29	30	82	8	0,28
24 4-24ML	35	30	82	10	0,35

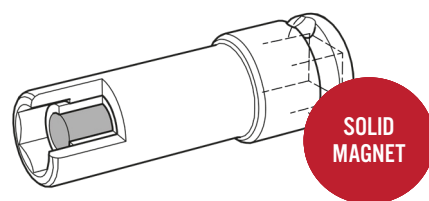
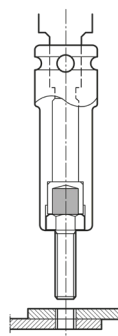

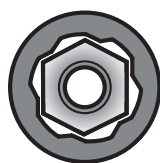
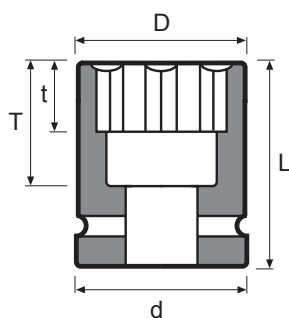

11 times more powerful magnets!

We use neodym magnets. They are 11 times stronger than ferrite magnets.

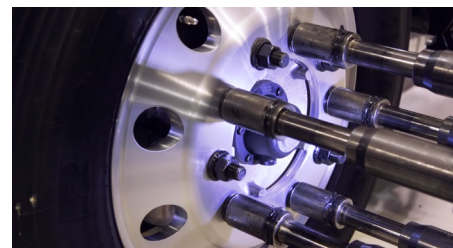

Part No	D mm	d mm	L mm	t mm	T mm	kg
10 4-SF10	17	25	38	7	22	0,08
11 4-SF11	18,5	25	38	7	22	0,08
12 4-SF12	19,7	25	38	8	22	0,08
13 4-SF13	21	25	38	8	22	0,08
14 4-SF14	22,5	25	38	10	22	0,08
15 4-SF15	23,5	30	38	10	22	0,16
16 4-SF16	24,5	30	38	10	20	0,13
17 4-SF17	26	30	38	10	20	0,13
18 4-SF18	27,5	30	38	11	20	0,13
19 4-SF19=3/4	29	30	38	11	20	0,13
20 4-SF20	30	30	38	12	20	0,12
21 4-SF21	31	30	38	12	20	0,13
22 4-SF22	32,5	30	38	12	20	0,14
24 4-SF24	35	30	40	14	21	0,16
27 4-SF27=1 1/16	38,5	30	45	16	25	0,21



 Surface drive hylsor är avsedda för segdragande mutterdragare. De är i första hand avsedda att underlätta hylsans antring av skruv/ mutter vid t ex montage med flerspindlig mutterdragare.

Momentos patenterade nyckelgrepp har flat kontaktyta mellan krafthylsan och muttern/skruvskallen.

 Surface drive sockets are intended for stall type nutrunners. Their primary use is to facilitate when the socket is entering the fastener, for example, mounting with a multispindle nut runner.

Momento's patented surface drive opening has flat areas of contact to the nut or bolt.

 Surface drive Steckschlüssel sind für Drehschrauber bestimmt. In erster Linie sollen sie dem Steckschlüssel die Passform der Schraube/ Mutter erleichtern, wenn sie zB mit einem mehrspindel Drehschrauber montiert werden.

Die patentierte Momento Surface-Drive-Öffnung hat flache Kontaktflächen zu Muttern und Bolzen.

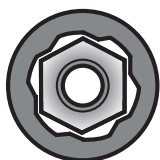
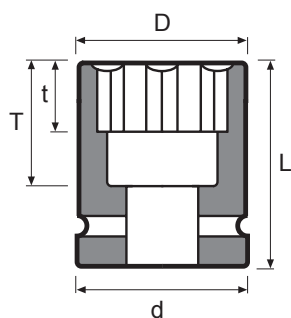

Part No	D mm	d mm	L mm	t mm	T mm	kg	
8	4-SF8L	14,5	25	82	5	64	0,14
10	4-SF10L	17	25	82	7	64	0,14
11	4-SF11L	18,5	25	82	7	64	0,16
12	4-SF12L	19,7	25	82	8	64	0,16
13	4-SF13L	21	25	82	8	64	0,18
14	4-SF14L	22,5	25	82	10	64	0,19
15	4-SF15L	23,5	30	82	10	64	0,23
16	4-SF16L	24,5	30	82	10	64	0,22
17	4-SF17L	26	30	82	10	64	0,24
19	4-SF19=3/4L	29	30	82	11	64	0,29
21	4-SF21L	31	30	82	12	64	0,31
22	4-SF22L	32,5	30	82	12	63	0,30
24	4-SF24L	35	30	82	14	63	0,35
25	4-SF25L	37	30	82	14	63	0,36
27	4-SF27=1 1/16L	38,5	30	82	16	63	0,39

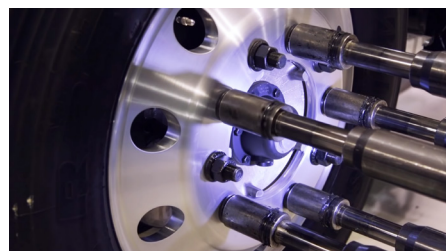

Surface drive hylsor är avsedda för segdragande mutterdragare. De är i första hand avsedda att underlätta hylsans äntring av skruv/mutter vid t ex montage med flerspindlig mutterdragare.

Momentos patenterade nyckelgrepp har flat kontaktyta mellan krafthylsan och muttern/skruvskallen.



Surface drive sockets are intended for stall type nutrunners. Their primary use is to facilitate when the socket is entering the fastener, for example, mounting with a multispindle nut runner.

Momento's patented surface drive opening has flat areas of contact to the nut or bolt.

Surface drive Steckschlüssel sind für Drehschrauber bestimmt. In erster Linie sollen sie dem Steckschlüssel die Passform der Schraube/Mutter erleichtern, wenn sie zB mit einem mehrspindel Drehschrauber montiert werden.

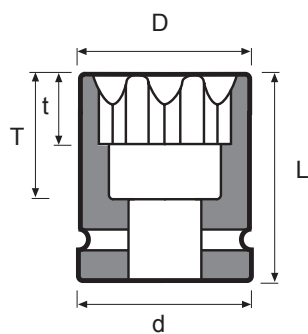
Die patentierte Momento Surface-Drive-Öffnung hat flache Kontaktflächen zu Muttern und Bolzen.



	Part No	D mm	d mm	L mm	t mm	T mm	 kg
E10	4-E10	14,5	25	38	7	22	0,07
E12	4-E12	16,5	25	38	8,5	22	0,08
E14	4-E14	18,5	25	38	9,5	22	0,09
E16	4-E16	20,5	25	38	10,5	22	0,08
E18	4-E18	22,5	25	38	12	22	0,08
E20	4-E20	24,5	30	38	13,2	22	0,13
E24	4-E24	30	30	45	15	29	0,17

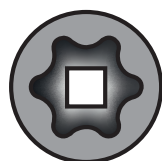

 Passar till på marknaden vanligt förekommande skruvar med hexalobulärt grepp.

 Fits on the market commonly used screws with hexalobular driving feature.

 Passend zu den auf dem Markt gängigen Schrauben mit Innensechsrund Antrieb

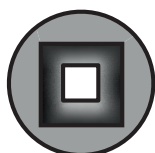
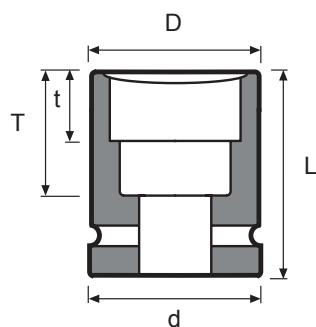

Part No	D mm	d mm	L mm	t mm	T mm	kg	
7	4-4K7	13,5	25	38	7	20	0,07
8	4-4K8	16	25	38	8	20	0,08
9	4-4K9	17,5	25	38	9	20	0,08
10	4-4K10	19,5	25	38	10	20	0,08
11	4-4K11	21	25	38	11	20	0,09
12	4-4K12	22,5	25	38	12	20	0,12
13	4-4K13	29,5	25	50	17	32	0,12
14	4-4K14	30	25	50	14	32	0,19
15	4-4K15	30,5	30	50	15	32	0,15
16	4-4K16	30,5	30	50	16	32	0,15
17	4-4K17	31,5	30	50	17	32	0,21
18	4-4K18	32,5	30	50	18	32	0,16
19	4-4K19=3/4	35	30	50	19	32	0,24
20	4-4K20	36,5	30	50	20	32	0,23
21	4-4K21	38	30	50	21	32	0,26
22	4-4K22	40,5	30	50	22	32	0,29
24	4-4K24	42,5	30	50	22	32	0,30
27	4-4K27=1 1/16	49	40	60	24	41	0,56
30	4-4K30=1 3/16	54	40	60	25	41	0,64
5/16	4-4K5/16	16	25	38	8	20	0,08
3/8	4-4K3/8	19,5	25	38	10	20	0,09
1/2	4-4K1/2	29,5	25	50	17	32	0,19
9/16	4-4K9/16	30	25	50	14	32	0,12
5/8	4-4K5/8	30,5	30	50	16	32	0,21
3/4	4-4K19=3/4	35	30	50	19	32	0,24
1	4-4K1	44	40	60	22	42	0,50
1 1/8	4-4K1 1/8	51	40	60	25	41	0,26

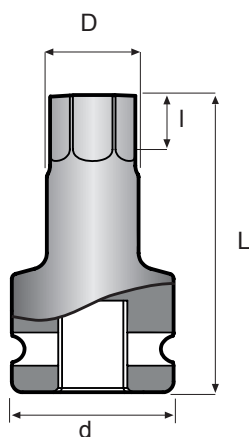



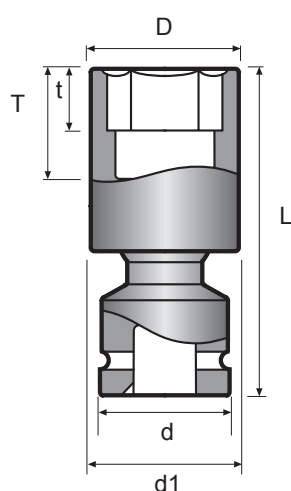



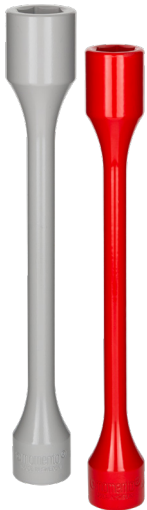
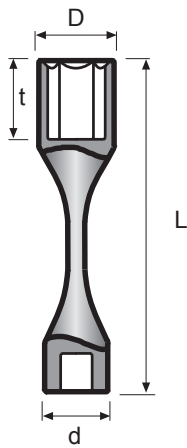







Part No	D mm	d mm	L mm	l mm	kg	
1/2 8	4-U6K8	10	30	55	7	0,12
1/2 10	4-U6K10	13	30	55	8	0,13
1/2 12	4-U6K12	15	30	55	9	0,14
1/2 14	4-U6K14	17	30	55	10	0,15



Part No	D mm	d mm	d1 mm	L mm	t mm	T mm	kg
12 US4-12	17,8	25	25	70	8	16	0,14
13 US4-13	19	25	25	70	8	18	0,15
14 US4-14	21	25	25	70	10	18	0,15
15 US4-15	22	25	25	70	10	18	0,16
16 US4-16	24	25	25	70	10	18	0,16
17 US4-17	25	26	30	70	10	15	0,18
18 US4-18	26	26	30	70	11	15	0,18
19 US4-19	27	26	30	70	11	15	0,18
21 US4-21	30	26	30	70	12	15	0,18
22 US4-22	31	26	31	70	12	15	0,19
24 US4-24	33	26	33	70	14	15	0,23
12 US4-12L	18	25	25	150	8	18	0,25
13 US4-13L	19	29	25	150	8	18	0,27
14 US4-14L	21	29	25	150	10	18	0,26
15 US4-15L	22	29	25	150	10	18	0,27
16 US4-16L	24	29	25	150	10	18	0,27
17 US4-17L	25	29	30	150	10	15	0,34
18 US4-18L	26	29	30	150	11	15	0,35
19 US4-19L	27	29	30	150	11	15	0,34
21 US4-21L	30	29	30	150	12	15	0,35
22 US4-22L	31	29	31	150	12	15	0,35
24 US4-24L	33	29	33	150	14	15	0,37
7/16" US4-7/16	16,5	25	25	70	7	16	0,14
1/2" US4-1/2	19	25	25	70	8	16	0,15
9/16" US4-9/16	20,3	25	25	70	9	16	0,15
5/8" US4-5/8	22,4	25	25	70	10	16	0,16
11/16" US4-11/16	24	25	25	70	11	15	0,16
3/4" US4-19=3/4	26,5	26	30	70	13	15	0,18
13/16" US4-13/16	30	26	30	70	12	18	0,18
7/8" US4-7/8	31	26	31	70	12	18	0,19
15/16" US4-15/16	33	26	33	70	14	20	0,23
7/16" US4-7/16L	16,5	25	25	150	7	16	0,25
1/2" US4-1/2L	19	25	25	150	8	16	0,25
9/16" US4-9/16L	20,3	25	25	150	9	16	0,25
5/8" US4-5/8L	22,4	25	25	150	10	16	0,27
11/16" US4-11/16	24	29	25	150	11	15	0,34
3/4" US4-19=3/4L	26,5	29	30	150	13	15	0,34
13/16" US4-13/16L	30	29	30	150	12	18	0,35
7/8" US4-7/8L	31	29	31	150	12	18	0,35
15/16" US4-15/16L	33	29	33	150	14	20	0,37



	Part No	D mm	d mm	L mm	t mm	Färg Colour Farbe	kg
17	4-17-75NMC	26,5	27	220	25		0,27
17	4-17-95NMC	26,5	27	220	25		0,28
17	4-17-110NMC	26,5	27	220	25		0,29
17	4-17-120NMC	26,5	27	220	25		0,29
19	4-19-75NMC	29	27	220	25		0,28
19	4-19-90NMC	29	27	220	25		0,28
19	4-19-110NMC	29,5	27	220	25		0,31
19	4-19-120NMC	29,5	27	220	25		0,36
19	4-19-140NMC	31	27	220	25		0,33
19	4-19-170NMC	31	27	220	25		0,39
21	4-21-80NMC	31	27	220	25		0,32
21	4-21-110NMC	31	27	220	25		0,32

 Momenthylsorna är konstruerade för åtdragning av bilhjul med slående mutterdragare. Den långa och smala midjan dämpar överskottskraften i mutterdragaren.

Det faktiska åtdragningsmomentet beror på mutterdragarens kondition och lufttrycket. Kontrollera därför regelbundet med momentnyckel.

 Torque sockets are designed for tightening wheel nuts using an impact wrench. The long and narrow waistline absorbs the excess power of the impact wrench.

The actual torque depends on the condition of the impact wrench and the pneumatic equipment. Regularly check by means of a torque wrench.

 Drehmoment-Steckschlüssel sind für das Festziehen von Radmutter mit Schlagschraubern konstruiert. Das dünne Mittelteil verhindert überschüssiges Drehmoment des Schlagschraubers.

Das tatsächliche Drehmoment hängt von der Leistung des Schlagschraubers ab. Regelmässige Kontrollen mit Drehmoment-Schlüsseln sind empfehlenswert.



**THERE IS ONLY
ONE ORIGINAL!**

 momento

KOPIERAD MEN ALDRIG ÅTERSskapAD

Vi på Momento uppfann momenthylsan för mer än 40 år sedan och leder fortfarande utvecklingen av momentbegränsande verktyg.

Du behöver original-momenthylsan för att vara säker på att du:

- Drar åt hjulmuttrarna med precision till bilens föreskrivna moment
- Core drive™ förbättrar styrkan samt är skonsam mot hjulmuttrar
- Skonar fälgar och förhindrar att bromsskivor blir skeva

Lätt att använda!

- 1/2" drivfyrkant passar vanliga mutterdragare.
- Extra djup sexkant passar höga hjulmuttrar och kupolmuttrar.
- Färgkodning för snabb identifiering och sökning i rekommendationstabell.

COPIED BUT NEVER REPRODUCED

Here at Momento we invented the torque sockets more than 40 years ago and we still lead the development in torque limiting tools.

You need the original one-piece torque limiting tool to make sure that you:

- Tighten wheel nuts accurately and according to factory specs
- Core drive™ spare wheel nuts
- Protect the rims and prevent brake disk distortion

Easy to use!

- 1/2" square drive fits standard impact guns
- Extra deep hexagon accommodating high or domed wheel nuts
- Colour-coded for easy identification and quick reference to selection chart

OFT KOPIERT ABER NIE ERREICHT

Hier bei Momento haben wir vor über 40 Jahren den Drehmoment-Steckschlüssel erfunden und sind weiterhin führend in der Entwicklung von drehmoment-begrenzenden Werkzeugen.

Sie brauchen das Original einteilige Werkzeug zur Begrenzung der Drehzahl, um sicherzustellen, dass:

- Radmuttern genau und nach Herstellervorgaben festgezogen werden
- Radmuttern durch unseren Core drive™ geschont werden
- Felgen geschont und ein Verziehen der Bremsscheiben verhindert wird

Einfach in der Handhabung!

- 1/2" Vierkant-Antrieb passt auf alle gängigen Kraftschrauber
- Extra tiefeintauchender 6-Kant welcher runde oder gewölbte Radmuttern aufnimmt
- Farbkodierung für einfaches Erkennen und schnelle Zuordnung in Auswahltablelle

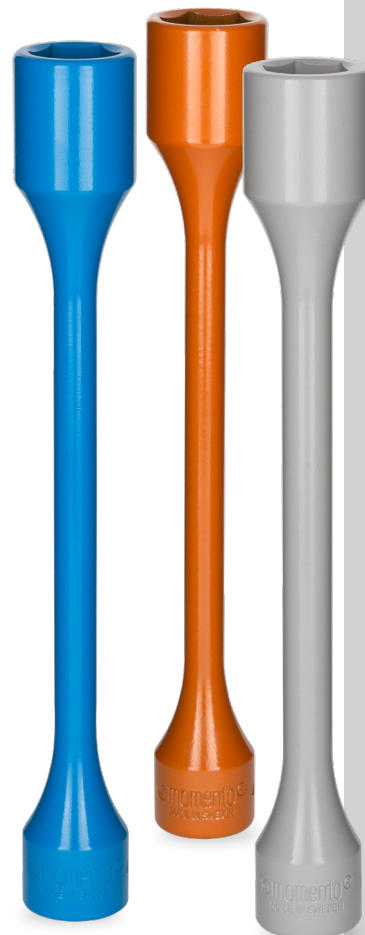



Djupa hylsor

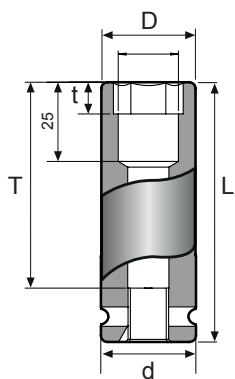

Deep sockets

Tiefe Steckschlüssel

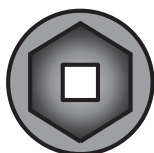
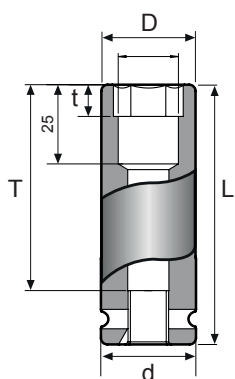

	Part No	D mm	d mm	L mm	t mm	T mm	 kg
17	4-17LD	26	30	82	10	64	0,24
19	4-19LD	29	30	82	11	64	0,29
21	4-21LD	31	30	82	12	64	0,26
22	4-22LD	32,5	30	82	12	64	0,26

Djupa hylsor med
roterande plastskyddDeep sockets with
rotating plastic coverTiefe Steckschlüssel mit
rotierendem Schutz aus Kunststoff

	Part No	D mm	d mm	L mm	t mm	T mm	 kg
17	4-17LDRP	27	30	82	10	64	0,24
19	4-19LDRP	30	30	82	11	64	0,29
21	4-21LDRP	32	30	82	12	64	0,26
22	4-22LDRP	33,5	30	82	12	64	0,26

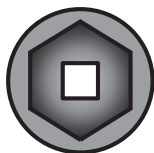

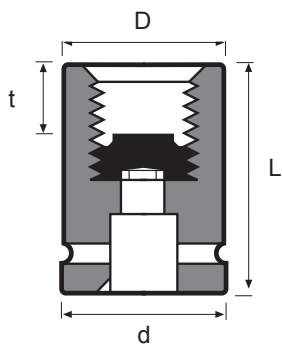

⊙	Part No	Stigning Pitch Steigung	D mm	d mm	L mm	t mm	kg
M6	4-M6	1	14	25	65	8	0,10
M8	4-M8	1,25	19	25	65	12	0,13
M10	4-M10	1,5	22	25	65	14	0,14
M12	4-M12	1,75	24	25	65	16	0,18
M14	4-M14	2	24	25	65	18	0,19
M16	4-M16	2	24	25	65	20	0,17
M18	4-M18	2,5	30	30	82	20	0,35
M20	4-M20	2,5	30	30	82	25	0,31
M22	4-M22	2,5	32	30	82	25	0,35
M24	4-M24	3	34	30	82	25	0,38
M27	4-M27	3	40	40	100	28	0,74
1/4"-20 UNC	4-UNC1/4		14	25	65	8	0,10
5/16"-18 UNC	4-UNC5/16		19	25	65	12	0,13
3/8"-16 UNC	4-UNC3/8		22	25	65	14	0,17
7/16"-14 UNC	4-UNC7/16		22	25	65	16	0,19
1/2"-13 UNC	4-UNC1/2		24	25	65	16	0,19
9/16"-12 UNC	4-UNC9/16		24	25	65	20	0,17
5/8"-11 UNC	4-UNC5/8		24	25	65	20	0,17
3/4"-10 UNC	4-UNC3/4		30	30	82	22	0,32
7/8"-9 UNC	4-UNC7/8		32	30	82	25	0,37
1"-8 UNC	4-UNC1		40	40	100	35	0,78
1 1/8"-7 UNC	4-UNC1 1/8		41	40	100	30	0,77
1 1/4"-7 UNC	4-UNC1 1/4		45	40	100	35	0,89
1 1/2"-6 UNC	4-UNC1 1/2		53	40	100	40	1,15

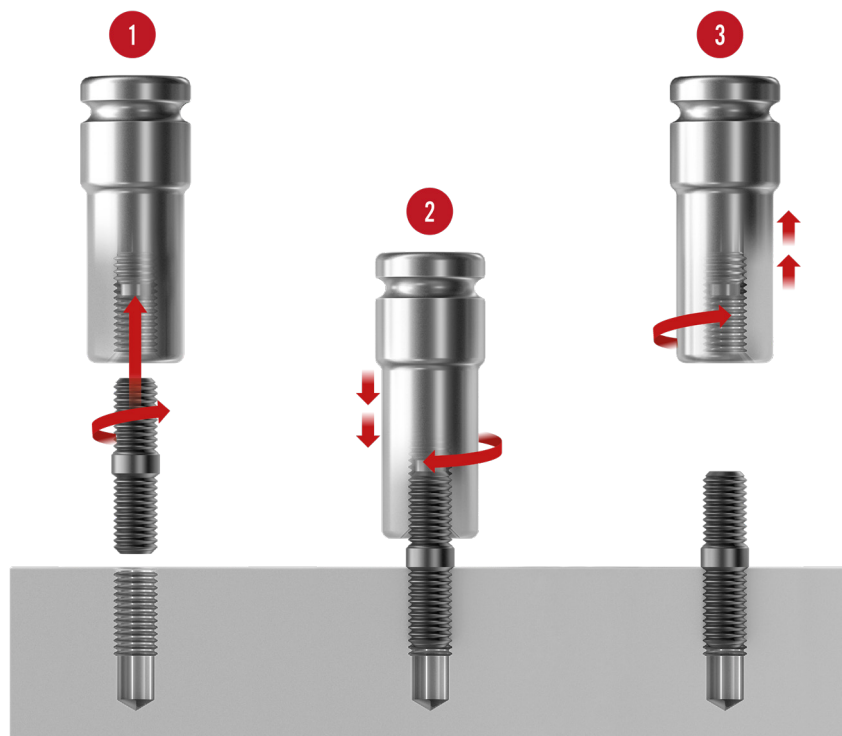

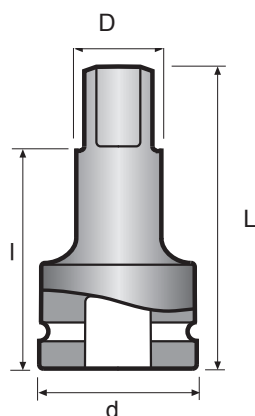

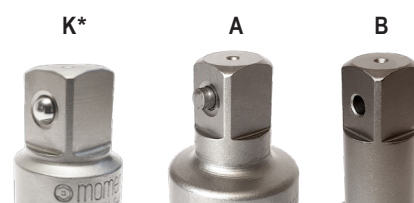

□	■	Part No	Model	D mm	d mm	L mm	l mm	kg
1/2	1/2	EB44-2	A	16,6	29	51	35,5	0,15
1/2	1/2	EB44-3	A	16,6	29	76	60,5	0,20
1/2	1/2	EB44-4	A	16,6	29	102	86,5	0,24
1/2	1/2	EB44-5	A	16,6	29	127	111,5	0,27
1/2	1/2	EB44-6	A	16,6	29	152	136,5	0,32
1/2	1/2	EB44-7	A	16,6	29	178	162,5	0,36
1/2	1/2	EB44-8	A	16,6	29	203	187,5	0,41
1/2	1/2	EB44-10	A	16,6	29	254	238,5	0,49
1/2	1/2	EB44-12	A	16,6	29	305	289,5	0,58

1/2	3/8	EB41-3	A	16,6	25	76	65	0,14
1/2	3/8	EB41-4	A	16,6	25	102	91	0,19
1/2	3/8	EB41-5	A	16,6	25	127	116	0,23
1/2	3/8	EB41-6	A	16,6	25	152	141	0,28
1/2	3/8	EB41-7	A	16,6	25	178	167	0,32
1/2	3/8	EB41-10	A	16,6	25	254	243	0,45



 * K: Våra 1/4", 3/8", 1/2" och 5/8" förlängare kan även fås med fjädrande kula som låsning, lägg till ett "K" efter artikelnumret för utförande med kula.

 * K: Our 1/4", 3/8", 1/2" and 5/8" extensions can also be supplied with spring ball as locking, add a "K" for the part number for the version with ball.

 * K: Unsere 1/4", 3/8", 1/2" und 5/8" verlängerungen können auch mit Federkugel als Verriegelung geliefert werden. Fügen Sie ein "K" für die Teilenummer der Version mit Kugel hinzu.

Can't find what you're looking for?

We can manufacture special tools to meet your individual requirements.

Contact us and we will help you!



Universalknutar

Universal joints

Kugelgelenke

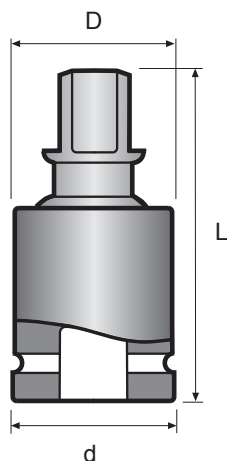

□	■	Part No	Model	D mm	d mm	L mm	kg
1/2	1/2	UK44S	A	30	28	63	0,17
1/2	1/2	UK44-IMP*	A	40	30	75	0,30

* Heavy duty version for use with impact tool



- 🇸🇪 Momentos 1/4", 3/8" och 1/2" universalknutar är fjäderbelastade och kan ställas i önskad vinkel.
- 🇬🇧 1/4", 3/8" and 1/2" Momento universal joints are spring loaded and can be preset at an angle.
- 🇩🇪 Momento Kugelgelenke mit 1/4", 3/8" und 1/2" Vierkantantrieb sind federbelastet und auf Winkel einstellbar.

Övergångar

Adapters

Reduzierstücke

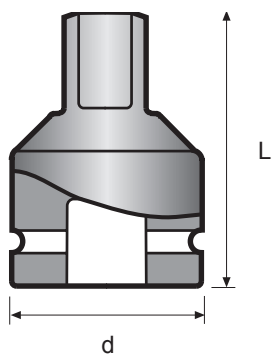

□	■	Part No	Model	d mm	L mm	kg
1/2	3/8	PA41	A	25	35	0,06
1/2	5/8	PA48	A	29	43	0,13
1/2	3/4	PA42	B	29	43	0,13

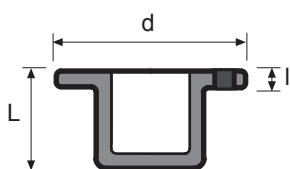
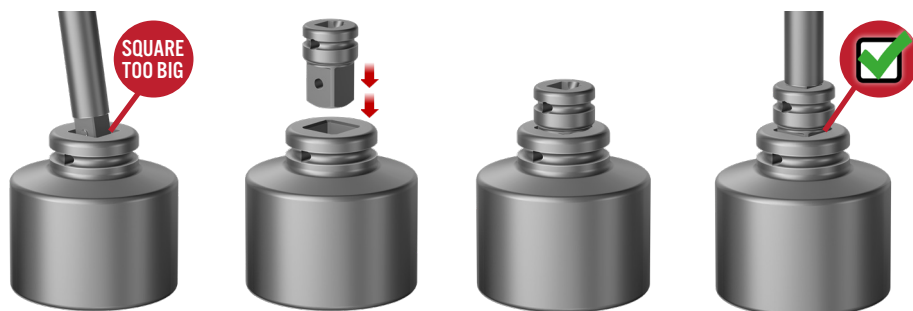

□	■	Part No	d mm	L mm	l mm	kg
1/2	3/4	IPA42	44	28	5	0,11

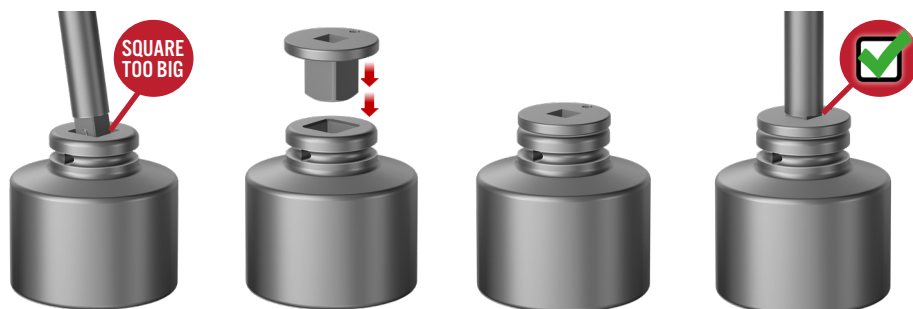

The total height

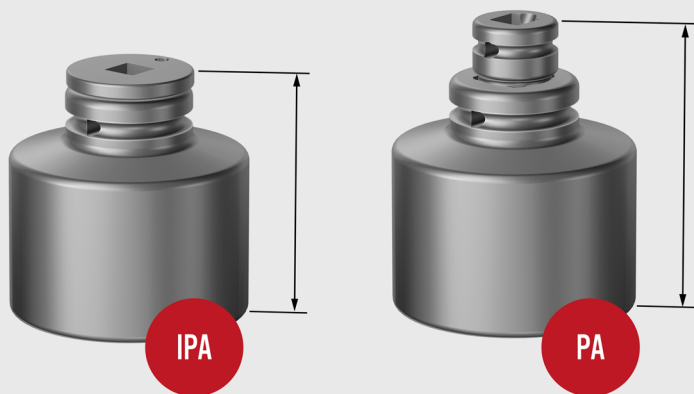

Secured with

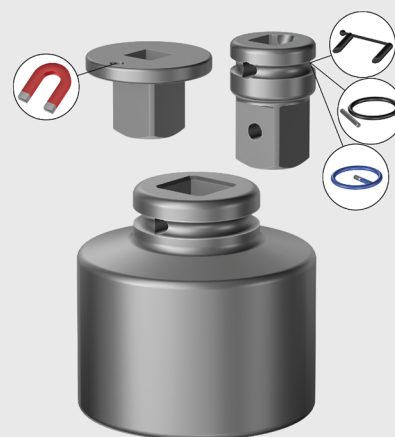

i Info about different types of securing in the beginning of the catalogue.

K*

A

B



🇸🇪 * K: Våra 1/4", 3/8", 1/2" och 5/8" universalknutar kan även fås med fjädrande kula som låsning, lägg till ett "K" efter artikelnumret för utförande med kula.

🇬🇧 * K: Our 1/4", 3/8", 1/2" and 5/8" universal joints can also be supplied with spring ball as locking, add a "K" for the part number for the version with ball.

🇩🇪 * K: Unsere 1/4", 3/8", 1/2" und 5/8" Universalgelenke können auch mit Federkugel als Verriegelung geliefert werden. Fügen Sie ein "K" für die Teilenummer der Version mit Kugel hinzu.



🇸🇪 **👍** Säkras med Momento Locking, Ret ring eller Pinne och O-ring.

🚫 Kräver större utrymme än IPA

🇬🇧 **👍** Secured with Momento Locking, Ret ring or Pin and O-ring.

🚫 Requires more space than IPA

🇩🇪 **👍** Mit Momento Locking, Ret-Ring oder Sicherungsstifte und O-Ringe gesichert.

🚫 Benötigt mehr Platz als IPA



🇸🇪 **👍** Används när utrymmet är begränsat

🚫 Kan inte säkras med pinne och O-ring (Insatsövergången hålls kvar i hylsan med hjälp av en magnet)

🇬🇧 **👍** Used when space is limited

🚫 Cannot be secured with pin and O-ring (The insert adapter sticks to the socket by means of a magnet)

🇩🇪 **👍** Wird verwendet, wenn der Platz begrenzt ist

🚫 Kann nicht mit Sicherungsstifte und O-Ringe gesichert werden (Ein Magnet hält das Reduzierstück am Kraftsteckschlüssel)

The differens between IPA and PA adapters

There are some facts that you need to know to be able to pick the best adapter for your job.

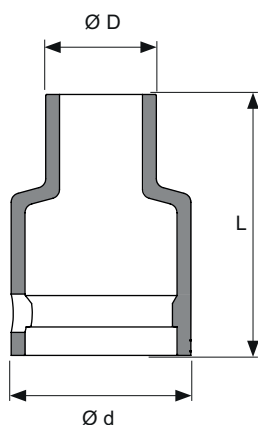

SIZE	FITS ON SOCKET	SOCKET WITH COVER	PLASTIC COVER	Ø d	Ø D	L
<i>METRIC</i>						
8	4-8	4-8RP	PC4-8	30	19,3	38,5
10	4-10	4-10RP	PC4-10	30	22	38,5
11	4-11	4-11RP	PC4-11	30	23,5	38,5
12	4-12	4-12RP	PC4-12	30	24,7	38,5
13	4-13	4-13RP	PC4-13	30	26	38,5
14	4-14	4-14RP	PC4-14	30	27,5	38,5
15	4-15	4-15RP	PC4-15	35	28,5	38,5
16	4-16	4-16RP	PC4-16	35	29,5	38,5
17	4-17	4-17RP	PC4-17	35	31	38,5
18	4-18	4-18RP	PC4-18	35	32,5	38,5
19	4-19=3/4	4-19=3/4RP	PC4-19	35	34	38,5
21	4-21	4-21RP	PC4-21	35	36	38,5
22	4-22	4-22RP	PC4-22	34,2	36,9	38,5
24	4-24	4-24RP	PC4-24	35	40	40,5
27	4-27=1 1/16	4-27=1 1/16RP	PC4-27	34,4	42,9	45,5
30	4-30=1 3/16	4-30=1 3/16RP	PC4-30	34,4	46,9	50,5
32	4-32	4-32RP	PC4-32	44,4	49,4	50,5
33	4-33	4-33RP	PC4-33	44,4	50,9	50,5
34	4-34	4-34RP	PC4-34	44,4	51,4	50,5
36	4-36	4-36RP	PC4-36	44,4	54,4	56,5
41	4-41	4-41RP	PC4-41	44,4	61,4	65,5
46	4-46=1 13/16	4-46=1 13/16RP	PC4-46	44,4	67,4	65,5

SILVERLINE™ COVER

Read more about the plastic covers on page 21

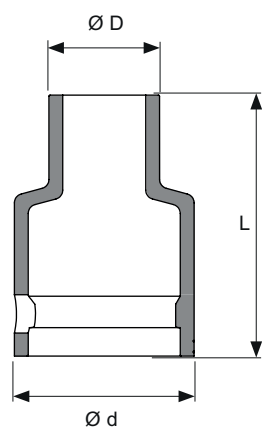

SIZE	FITS ON SOCKET	SOCKET WITH COVER	PLASTIC COVER	Ø d	Ø D	L
<i>METRIC LONG</i>						
10	4-10L	4-10LRP	PC4-10L	30	22	82,5
11	4-11L	4-11LRP	PC4-11L	30	23,5	82,5
12	4-12L	4-12LRP	PC4-12L	30	24,7	82,5
13	4-13L	4-13LRP	PC4-13L	29,2	25,2	82,5
14	4-14L	4-14LRP	PC4-14L	29,2	26,7	82,5
15	4-15L	4-15LRP	PC4-15L	35	28,5	82,5
16	4-16L	4-16LRP	PC4-16L	34,2	28,7	82,5
17	4-17L	4-17LRP	PC4-17L	35	31	82,5
18	4-18L	4-18LRP	PC4-18L	34,2	31,7	82,5
19	4-19=3/4L	4-19=3/4LRP	PC4-19L	34,2	33,2	82,5
21	4-21L	4-21LRP	PC4-21L	34,4	35,4	82,5
22	4-22L	4-22LRP	PC4-22L	34,4	36,9	82,5
24	4-24L	4-24LRP	PC4-24L	34,4	39,4	82,5
27	4-27=1 1/16L	4-27=1 1/16LRP	PC4-27L	34,4	42,9	82,5
30	4-30=1 3/16L	4-30=1 3/16LRP	PC4-30L	34,4	46,9	82,5
32	4-32L	4-32LRP	PC4-32L	44,4	49,4	82,5
33	4-33L	4-33LRP	PC4-33L	44,4	50,9	82,5
34	4-34L	4-34LRP	PC4-34L	44,4	51,4	82,5
36	4-36L	4-36LRP	PC4-36L	44,4	54,4	82,5
41	4-41L	4-41LRP	PC4-41L	44,4	61,4	82,5
46	4-46=1 13/16L	4-46=1 13/16LRP	PC4-46L	44,4	67,4	82,5

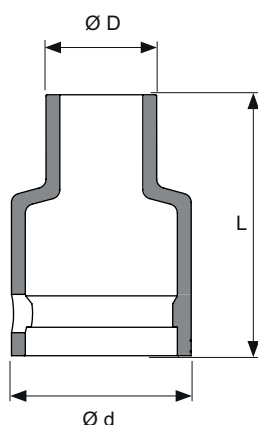

SIZE	FITS ON SOCKET	SOCKET WITH COVER	PLASTIC COVER	Ø d	Ø D	L
<i>METRIC</i>						
10	4-D6K10	4-D6K10RP	PC4-D6K10	30	22	38,5
11	4-D6K11	4-D6K11RP	PC4-D6K11	30	23,5	38,5
12	4-D6K12	4-D6K12RP	PC4-D6K12	30	24,7	38,5
13	4-D6K13	4-D6K13RP	PC4-D6K13	30	26	38,5
14	4-D6K14	4-D6K14RP	PC4-D6K14	30	27,5	38,5
15	4-D6K15	4-D6K15RP	PC4-D6K15	35	28,5	38,5
16	4-D6K16	4-D6K16RP	PC4-D6K16	35	29,5	38,5
17	4-D6K17	4-D6K17RP	PC4-D6K17	35	31	38,5
18	4-D6K18	4-D6K18RP	PC4-D6K18	35	32,5	38,5
19	4-D6K19=3/4	4-D6K19=3/4RP	PC4-D6K19	35	34	38,5
21	4-D6K21	4-D6K21RP	PC4-D6K21	35	36	38,5
22	4-D6K22	4-D6K22RP	PC4-D6K22	34,2	36,9	38,5
24	4-D6K24	4-D6K24RP	PC4-D6K24	35	40	40,5
27	4-D6K27=1 1/16	4-D6K27=1 1/16RP	PC4-D6K27	34,4	42,9	45,5
30	4-D6K30=1 3/16	4-D6K30=1 3/16RP	PC4-D6K30	34,4	46,9	50,5
32	4-D6K32	4-D6K32RP	PC4-D6K32	44,4	49,4	50,5
36	4-D6K36	4-D6K36RP	PC4-D6K36	44,4	54,4	56,5

METRIC LONG

10	4-D6K10L	4-D6K10LRP	PC4-D6K10L	30	22	82,5
11	4-D6K11L	4-D6K11LRP	PC4-D6K11L	30	23,5	82,5
12	4-D6K12L	4-D6K12LRP	PC4-D6K12L	30	24,7	82,5
13	4-D6K13L	4-D6K13LRP	PC4-D6K13L	29,2	25,2	82,5
14	4-D6K14L	4-D6K14LRP	PC4-D6K14L	29,2	26,7	82,5
15	4-D6K15L	4-D6K15LRP	PC4-D6K15L	35	28,5	82,5
16	4-D6K16L	4-D6K16LRP	PC4-D6K16L	34,2	28,7	82,5
17	4-D6K17L	4-D6K17LRP	PC4-D6K17L	35	31	82,5
18	4-D6K18L	4-D6K18LRP	PC4-D6K18L	34,2	31,7	82,5
19	4-D6K19=3/4L	4-D6K19=3/4LRP	PC4-D6K19L	34,2	33,2	82,5
21	4-D6K21L	4-D6K21LRP	PC4-D6K21L	34,4	35,4	82,5
22	4-D6K22L	4-D6K22LRP	PC4-D6K22L	34,4	36,9	82,5
24	4-D6K24L	4-D6K24LRP	PC4-D6K24L	34,4	39,4	82,5
27	4-D6K27=1 1/16L	4-D6K27=1 1/16LRP	PC4-D6K27L	34,4	42,9	82,5
30	4-D6K30=1 3/16L	4-D6K30=1 3/16LRP	PC4-D6K30L	34,4	46,9	82,5
32	4-D6K32L	4-D6K32LRP	PC4-D6K32L	44,4	49,4	82,5
36	4-D6K36L	4-D6K36LRP	PC4-D6K36L	44,4	54,4	82,5



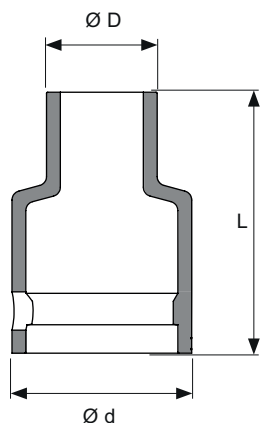

SIZE	FITS ON SOCKET	SOCKET WITH COVER	PLASTIC COVER	Ø d	Ø D	L
<i>METRIC</i>						
4	4-10M	4-10MRP	PC4-10M	30	22	38,5
10	4-11M	4-11MRP	PC4-11M	30	23,5	38,5
12	4-12M	4-12MRP	PC4-12M	30	24,7	38,5
13	4-13M	4-13MRP	PC4-13M	30	26	38,5
14	4-14M	4-14MRP	PC4-14M	30	27,5	38,5
15	4-15M	4-15MRP	PC4-15M	35	28,5	38,5
16	4-16M	4-16MRP	PC4-16M	35	29,5	38,5
17	4-17M	4-17MRP	PC4-17M	35	31	38,5
18	4-18M	4-18MRP	PC4-18M	35	32,5	38,5
19	4-19=3/4M	4-19=3/4MRP	PC4-19M	35	34	38,5
21	4-21M	4-21MRP	PC4-21M	35	36	38,5
22	4-22M	4-22MRP	PC4-22M	34,2	36,9	38,5
24	4-24M	4-24MRP	PC4-24M	35	40	40,5

METRIC LONG

10	4-10ML	4-10MLRP	PC4-10ML	30	22	82,5
12	4-12ML	4-12MLRP	PC4-12ML	30	24,7	82,5
13	4-13ML	4-13MLRP	PC4-13ML	29,2	25,2	82,5
14	4-14ML	4-14MLRP	PC4-14ML	29,2	26,7	82,5
15	4-15ML	4-15MLRP	PC4-15ML	35	28,5	82,5
16	4-16ML	4-16MLRP	PC4-16ML	34,2	28,7	82,5
17	4-17ML	4-17MLRP	PC4-17ML	35	31	82,5
18	4-18ML	4-18MLRP	PC4-18ML	34,2	31,7	82,5
19	4-19=3/4ML	4-19=3/4MLRP	PC4-19ML	34,2	33,2	82,5
24	4-24ML	4-24MLRP	PC4-24ML	34,4	39,4	82,5

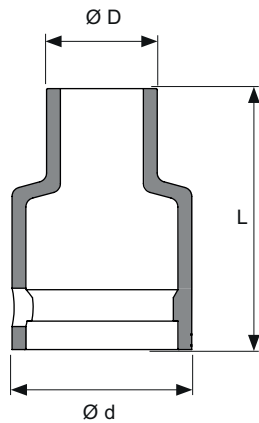

SIZE	FITS ON SOCKET	SOCKET WITH COVER	PLASTIC COVER	Ø d	Ø D	L
<i>METRIC</i>						
10	4-SF10	4-SF10RP	PC4-SF10	30	22	38,5
11	4-SF11	4-SF11RP	PC4-SF11	30	23,5	38,5
12	4-SF12	4-SF12RP	PC4-SF12	30	24,7	38,5
13	4-SF13	4-SF13RP	PC4-SF13	30	26	38,5
14	4-SF14	4-SF14RP	PC4-SF14	30	27,5	38,5
15	4-SF15	4-SF15RP	PC4-SF15	35	28,5	38,5
16	4-SF16	4-SF16RP	PC4-SF16	35	29,5	38,5
17	4-SF17	4-SF17RP	PC4-SF17	35	31	38,5
18	4-SF18	4-SF18RP	PC4-SF18	35	32,5	38,5
19	4-SF19=3/4	4-SF19=3/4RP	PC4-SF19	35	34	38,5
21	4-SF21	4-SF21RP	PC4-SF21	35	36	38,5
22	4-SF22	4-SF22RP	PC4-SF22	34,2	36,9	38,5
24	4-SF24	4-SF24RP	PC4-SF24	35	40	40,5
27	4-SF27=1 1/16	4-SF27=1 1/16RP	PC4-SF27	34,4	42,9	45,5

METRIC LONG

10	4-SF10L	4-SF10LRP	PC4-SF10L	30	22	82,5
11	4-SF11L	4-SF11LRP	PC4-SF11L	30	23,5	82,5
12	4-SF12L	4-SF12LRP	PC4-SF12L	30	24,7	82,5
13	4-SF13L	4-SF13LRP	PC4-SF13L	29,2	25,2	82,5
14	4-SF14L	4-SF14LRP	PC4-SF14L	29,2	26,7	82,5
15	4-SF15L	4-SF15LRP	PC4-SF15L	35	28,5	82,5
16	4-SF16L	4-SF16LRP	PC4-SF16L	34,2	28,7	82,5
17	4-SF17L	4-SF17LRP	PC4-SF17L	35	31	82,5
18	4-SF18L	4-SF18LRP	PC4-SF18L	34,2	31,7	82,5
19	4-SF19=3/4L	4-SF19=3/4LRP	PC4-SF19L	34,2	33,2	82,5
21	4-SF21L	4-SF21LRP	PC4-SF21L	34,4	35,4	82,5
22	4-SF22L	4-SF22LRP	PC4-SF22L	34,4	36,9	82,5
24	4-SF24L	4-SF24LRP	PC4-SF24L	34,4	39,4	82,5
27	4-SF27=1 1/16L	4-SF27=1 1/16LRP	PC4-SF27L	34,4	42,9	82,5

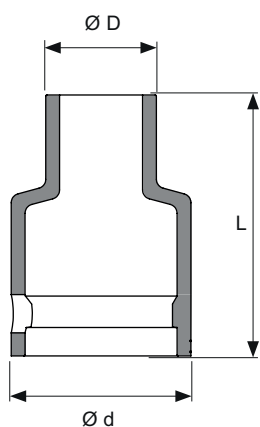

SIZE	FITS ON SOCKET	SOCKET WITH COVER	PLASTIC COVER	Ø d	Ø D	L
<i>METRIC</i>						
10	4-E10	4-E10RP	PC4-E10	30	19,3	38,5
12	4-E12	4-E12RP	PC4-E12	30	21,5	38,5
14	4-E14	4-E14RP	PC4-E14	30	23,5	38,5
16	4-E16	4-E16RP	PC4-E16	30	25,5	38,5
18	4-E18	4-E18RP	PC4-E18	30	27,5	38,5
20	4-E20	4-E20RP	PC4-E20	35	29,5	38,5

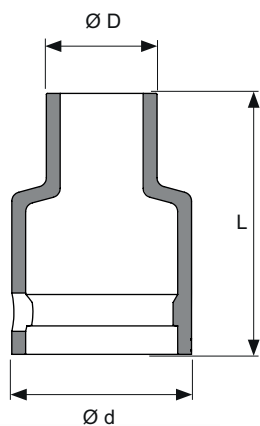

SIZE	FITS ON SOCKET	SOCKET WITH COVER	PLASTIC COVER	Ø d	Ø D	L
<i>METRIC</i>						
2	EB44-2	EB44-2RP	PCEB44-2	33,2	20,8	35
3	EB44-3	EB44-3RP	PCEB44-3	33,2	20,8	60
4	EB44-4	EB44-4RP	PCEB44-4	33,2	20,8	86
5	EB44-5	EB44-5RP	PCEB44-5	33,2	20,8	111
6	EB44-6	EB44-6RP	PCEB44-6	33,2	20,8	136
7	EB44-7	EB44-7RP	PCEB44-7	33,2	20,8	161,5
8	EB44-8	EB44-8RP	PCEB44-8	33,2	20,8	186,5
10	EB44-10	EB44-10RP	PCEB44-10	33,2	20,8	237,5
12	EB44-12	EB44-12RP	PCEB44-12	33,2	20,8	288,5

Övergångar

Adapters

Reduzierstücke

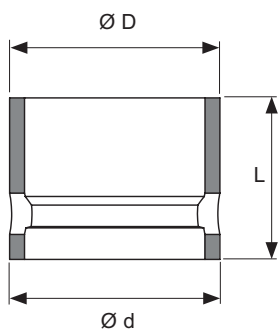

SIZE	FITS ON SOCKET	SOCKET WITH COVER	PLASTIC COVER	Ø d	Ø D	L
<i>INCH</i>						
1/2-3/8	PA41	PA41RP	PCPA41	29,2	29,2	21
1/2-5/8	PA48	PA48RP	PCPA48	33,2	33,2	19
1/2-3/4	PA42	PA42RP	PCPA42	33,2	33,2	19

Momento Gap Cover

Momento Gap Cover

Momento Gap Cover

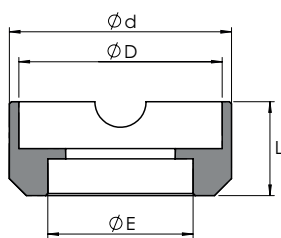

SIZE	FITS ON SOCKET	SOCKET & COVER	PLASTIC COVER	Ø d	Ø D	L	Ø E
8 - 14	4-8 > 4-14	---	PCEB44-D30	33	30,5	11	21,2
14 - 19	4-15 > 4-30	---	PCEB44-D35	38	35,6	11	21,2
32 - 46	4-32 > 4-46	---	PCEB44-D45	47,5	33,2	11	21,2

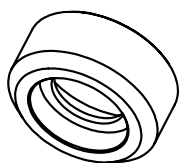

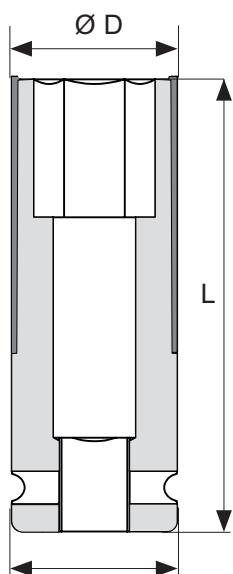

SIZE	SOCKET WITH COVER	PLASTIC COVER	Ø d	Ø D	L
<i>METRIC</i>					
17	4-17LDRP	4-17LDRP-2	30	27	82,5
19	4-19LDRP	4-19LDRP-2	30	30	82,5
21	4-21LDRP	4-21LDRP-2	30	32	82,5
22	4-22LDRP	4-22LDRP-2	30	33,5	82,5
24	4-24LDRP	4-24LDRP-2	30	36	82,5

**LDSRP:1 - SET**

4-17LDRP
4-19LDRP
4-21LDRP



SEE ALL SETS UNDER CHAPTER "SETS"



5/8"



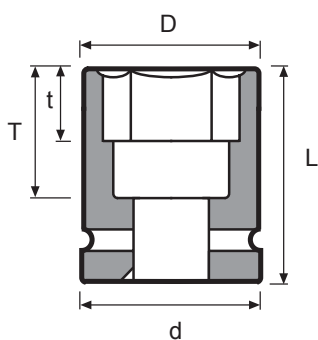

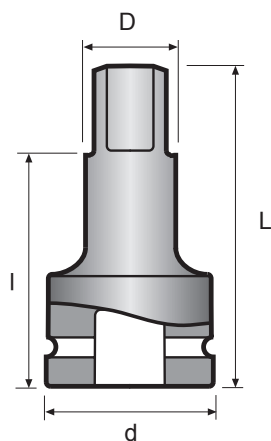

Part No	D mm	d mm	L mm	t mm	T mm	kg	
14	8-14	24	35	38	10	20	0,18
16	8-16	26	35	38	10	20	0,17
17	8-17	28	35	38	10	20	0,17
18	8-18	29	35	38	11	20	0,17
19	8-19=3/4	30	35	38	11	20	0,17
21	8-21	33	35	38	12	20	0,18
22	8-22	34	35	38	12	20	0,18
24	8-24	37	35	40	14	21	0,19
27	8-27=1 1/16	41	35	45	16	25	0,22
28	8-28	42	35	45	16	25	0,25
30	8-30=1 3/16	45	35	50	17	30	0,30
32	8-32	48	35	50	19	30	0,32
35	8-35=1 3/8	51	35	50	20	30	0,43
36	8-36	52	35	50	20	30	0,45

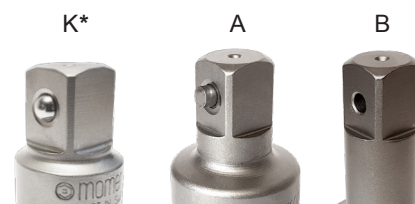

Part No	Model	D mm	d mm	L mm	l mm	kg		
5/8	5/8	EB88-3	A	20,7	35	76	59,7	0,30
5/8	5/8	EB88-6	A	20,7	35	152	135,7	0,50
5/8	5/8	EB88-10	A	20,7	35	254	237,7	0,80



 * K: Våra 1/4", 3/8", 1/2" och 5/8" förlängare kan även fås med fjädrande kula som låsning, lägg till ett "K" efter artikelnumret för utförande med kula.

 * K: Our 1/4", 3/8", 1/2" and 5/8" extensions can also be supplied with spring ball as locking, add a "K" for the part number for the version with ball.

 * K: Unsere 1/4", 3/8", 1/2" und 5/8" verlängerungen können auch mit Federkugel als Verriegelung geliefert werden. Fügen Sie ein "K" für die Teilenummer der Version mit Kugel hinzu.

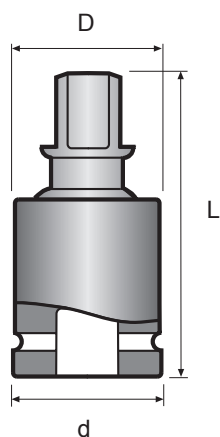

		Part No	Model	D mm	d mm	L mm	kg
5/8	5/8	UK88	A	38	35	70	0,31

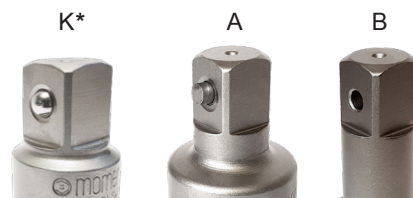

- Momentos 1/4", 3/8" och 1/2" universalknutar är fjäderbelastade och kan ställas i önskad vinkel.
- 1/4", 3/8" and 1/2" Momento universal joints are spring loaded and can be preset at an angle.
- Momento Kugelgelenke mit 1/4", 3/8" und 1/2" Vierkantantrieb sind federbelastet und auf Winkel einstellbar.

* K: Våra 1/4", 3/8", 1/2" och 5/8" universalknutar kan även fås med fjädrande kula som låsning, lägg till ett "K" efter artikelnumret för utförande med kula.

* K: Our 1/4", 3/8", 1/2" and 5/8" universal joints can also be supplied with spring ball as locking, add a "K" for the part number for the version with ball.

* K: Unsere 1/4", 3/8", 1/2" und 5/8" Universalgelenke können auch mit Federkugel als Verriegelung geliefert werden. Fügen Sie ein "K" für die Teilenummer der Version mit Kugel hinzu.



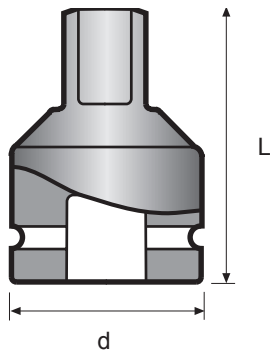

		Part No	Model	d mm	L mm	kg
5/8	1/2	PA84	A	35	49	0,18
5/8	3/4	PA82	B	35	54	0,23

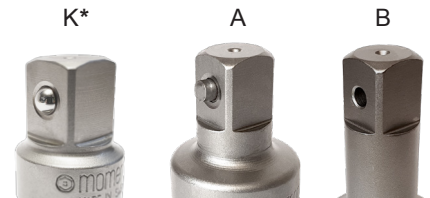

Var försiktig vid övergång till mindre fyrkant. Då mutterdragaren kan ge ett för högt vridmoment för den mindre tappen, lämnas ingen garanti.

Be careful when adapting to a smaller drive. As the power input may be too high for the smaller drive square, there is no guarantee when adapting down.

Seien Sie vorsichtig beim Übergang zu kleinen Antriebsvierkanten. Da das Drehmoment für den kleinen Vierkant zu hoch sein kann, kann keine Garantie übernommen werden.

* K: Våra 1/4", 3/8", 1/2" och 5/8" övergångar kan även fås med fjädrande kula som låsning, lägg till ett "K" efter artikelnumret för utförande med kula.

* K: Our 1/4", 3/8", 1/2" and 5/8" adapters can also be supplied with spring ball as locking, add a "K" for the part number for the version with ball.

* K: Unsere 1/4", 3/8", 1/2" und 5/8" reduzierstücke können auch mit Federkugel als Verriegelung geliefert werden. Fügen Sie ein "K" für die Teilenummer der Version mit Kugel hinzu.

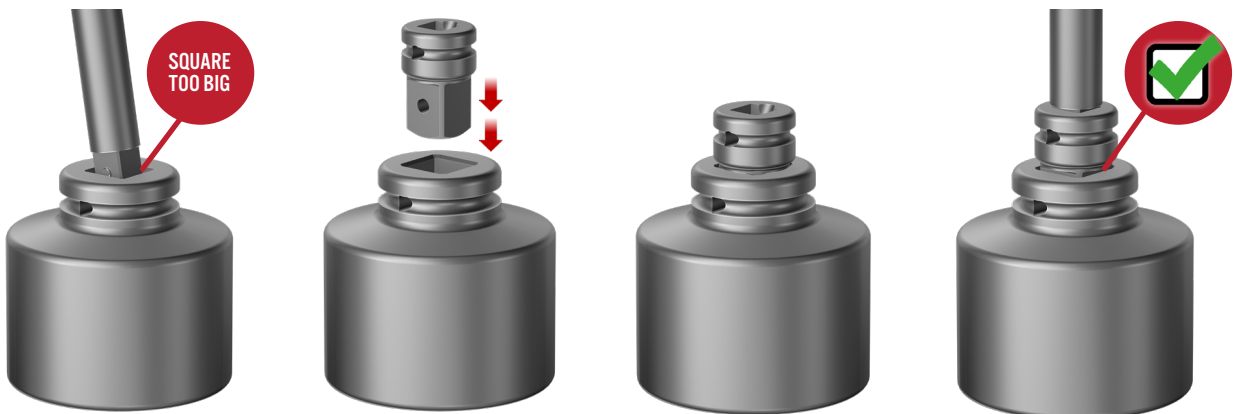

3/4"



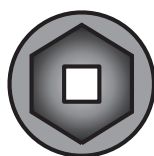
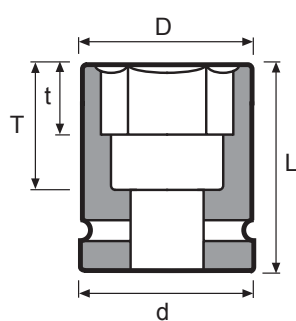

Part No	D mm	d mm	L mm	t mm	T mm	kg	
12	2-12	23	44	50	8	26	0,33
13	2-13	24	44	50	8	26	0,34
14	2-14	26	44	50	10	26	0,34
15	2-15	26	44	50	10	26	0,35
16	2-16	27	44	50	10	24	0,34
17	2-17	30	44	50	10	24	0,34
18	2-18	31	44	50	11	24	0,35
19	2-19=3/4	32	44	50	11	24	0,38
20	2-20	33	44	50	12	24	0,38
21	2-21	35	44	50	12	24	0,39
22	2-22	35	44	50	12	24	0,38
23	2-23	38	44	50	13	24	0,39
24	2-24	38,5	44	50	14	24	0,38
25	2-25	39	44	50	14	25	0,38
26	2-26	41	44	54	15	29	0,41
27	2-27=1 1/16	42	44	54	16	29	0,41
28	2-28	44	44	54	16	29	0,42
29	2-29	44	44	54	17	29	0,42
30	2-30=1 3/16	46	44	54	17	29	0,43
31	2-31	47	44	54	17	28	0,47
32	2-32	48,5	44	56	19	30	0,48
33	2-33	51	44	56	19	30	0,51
34	2-34	52	44	56	20	30	0,52
35	2-35=1 3/8	53	44	56	20	30	0,52
36	2-36	54	44	56	20	30	0,55
37	2-37	56	44	58	21	32	0,60
38	2-38=1 1/2	57	44	58	21	32	0,62
39	2-39	58	44	58	22	30	0,61
40	2-40	59	44	58	22	30	0,63
41	2-41	61	44	63	23	34	0,68
42	2-42	62	44	63	23	34	0,75
43	2-43=1 11/16	64	44	63	24	34	0,78
44	2-44	65	44	63	24	34	0,79
45	2-45	66	44	63	25	34	1,03
46	2-46=1 13/16	67	44	63	25	34	0,85
47	2-47	68,5	44	70	26	38	0,94
48	2-48	69	44	70	26	46	0,92
49	2-49	70	44	70	28	46	0,93
50	2-50	70	44	70	28	38	0,96
51	2-51	71	44	70	30	46	0,99
52	2-52	72	44	70	30	46	1,12
55	2-55	76	44	70	30	38	1,07

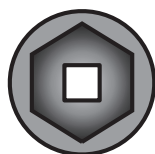
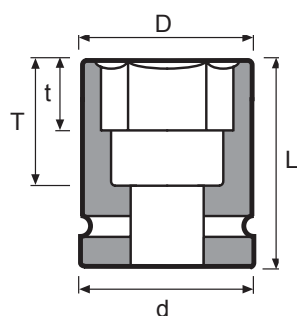

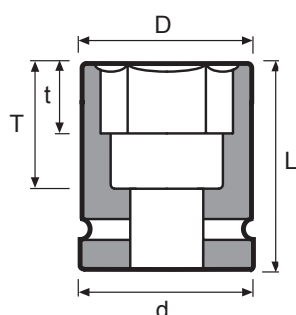

Part No	D mm	d mm	L mm	t mm	T mm	kg	
56	2-56	78	44	80	30	56	1,08
58	2-58	81	44	80	30	53	1,35
60	2-60	83	44	80	35	50	1,36
65	2-65=2 9/16	88	44	80	35	50	1,44
70	2-70=2 3/4	95	44	80	40	50	1,77
75	2-75	100	44	80	40	48	1,72
80	2-80	106	44	80	40	47	1,82
85	2-85	112	44	80	40	46	2,11
12	2-12L	25	44	100	8	76	0,65
13	2-13L	25	44	100	8	76	0,65
14	2-14L	27	44	100	10	76	0,37
15	2-15L	27	44	100	10	76	0,56
16	2-16L	28	44	100	10	74	0,52
17	2-17L	31	44	100	10	74	0,60
18	2-18L	32	44	100	11	74	0,64
19	2-19=3/4L	33	44	100	11	74	0,61
20	2-20L	34	44	100	12	74	0,65
21	2-21L	36	44	100	12	74	0,70
22	2-22L	36	44	100	12	74	0,70
23	2-23L	39	44	100	13	74	0,72
24	2-24L	39,5	44	100	14	74	0,72
25	2-25L	40	44	100	14	75	0,57
26	2-26L	42	44	100	15	74	0,73
27	2-27=1 1/16L	43	44	100	16	74	0,75
28	2-28L	44	44	100	16	74	0,77
29	2-29L	44	44	100	17	74	0,73
30	2-30=1 3/16L	46	44	100	17	74	0,83
31	2-31L	47	44	100	17	74	0,84
32	2-32L	48,5	44	100	19	74	0,89
33	2-33L	51	44	100	19	74	0,99
34	2-34L	52	44	100	20	74	1,00
35	2-35=1 3/8L	53	44	100	20	74	1,00
36	2-36L	54	44	100	20	74	1,04
37	2-37L	56	44	100	21	74	1,12
38	2-38=1 1/2L	57	44	100	21	72	1,18
40	2-40L	59	44	100	22	72	1,28

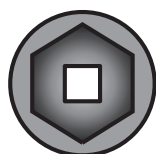
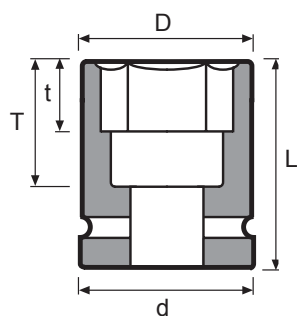

Part No	D mm	d mm	L mm	t mm	T mm	kg	
41	2-41L	61	44	100	23	72	1,27
42	2-42L	62	44	100	23	72	1,23
43	2-43=1 11/16L	64	44	100	24	72	1,35
44	2-44L	65	44	100	24	71	1,35
45	2-45L	66	44	100	25	71	1,35
46	2-46=1 13/16L	67	44	100	25	72	1,50
47	2-47L	68,5	44	100	26	76	1,46
48	2-48L	69	44	100	26	76	1,61
50	2-50L	70	44	100	28	72	1,34
51	2-51L	71	44	100	30	76	1,40
52	2-52L	72	44	100	30	76	1,84
55	2-55L	76	44	100	30	72	1,53
56	2-56L	78	44	100	30	76	1,65
60	2-60L	83	44	125	35	98	2,27
65	2-65=2 9/16L	88	44	125	35	96	2,39
70	2-70=2 3/4L	95	44	125	40	95	2,77
75	2-75L	100	44	125	40	93	
1/2	2-1/2	24	44	50	8	26	0,32
9/16	2-9/16	26	44	50	10	26	0,27
5/8	2-5/8	27	44	50	10	24	0,34
11/16	2-11/16	30	44	50	10	24	0,34
3/4	2-19=3/4	32	44	50	11	24	0,38
13/16	2-13/16	35	44	50	12	24	0,40
7/8	2-7/8	35	44	50	12	24	0,38
15/16	2-15/16	38,5	44	50	14	24	0,39
1	2-1	39	44	50	14	24	0,40
1 1/16	2-27=1 1/16	42	44	54	16	29	0,41
1 1/8	2-1 1/8	44	44	54	16	29	0,42
1 3/16	2-30=1 3/16	46	44	54	17	29	0,43
1 1/4	2-1 1/4	48,5	44	56	19	30	0,48
1 5/16	2-1 5/16	51	44	56	19	30	0,52
1 3/8	2-35=1 3/8	53	44	56	20	30	0,52
1 7/16	2-1 7/16	56	44	58	21	32	0,58
1 1/2	2-38=1 1/2	57	44	58	21	32	0,62
1 9/16	2-1 9/16	59	44	58	22	32	0,65
1 5/8	2-1 5/8	61	44	63	23	34	0,68



	Part No	D mm	d mm	L mm	t mm	T mm	 kg
1 11/16	2-43=1 11/16	64	44	63	24	34	0,78
1 3/4	2-1 3/4	65	44	63	24	34	0,80
1 13/16	2-46=1 13/16	67	44	63	25	34	0,85
1 7/8	2-1 7/8	69	44	70	26	38	0,95
1 15/16	2-1 15/16	70	44	70	28	46	1,15
2	2-2	71	44	70	30	38	0,99
2 1/16	2-2 1/16	72	44	70	30	46	0,92
2 1/8	2-2 1/8	74	44	70	30	46	0,95
2 3/16	2-2 3/16	78	44	80	30	56	1,34
2 1/4	2-2 1/4	80	44	80	30	54	1,32
2 5/16	2-2 5/16	81	44	80	30	53	1,43
2 3/8	2-2 3/8	83	44	80	35	53	1,43
2 1/2	2-2 1/2	86	44	80	35	52	1,41
2 9/16	2-65=2 9/16	88	44	80	35	51	1,44
2 3/4	2-70=2 3/4	95	44	80	40	50	1,77
5/8	2-5/8L	28	44	100	10	74	0,63
11/16	2-11/16L	31	44	100	10	74	0,60
3/4	2-19=3/4L	33	44	100	11	74	0,61
13/16	2-13/16L	36	44	100	12	74	0,68
7/8	2-7/8L	36	44	100	12	74	0,70
15/16	2-15/16L	39,5	44	100	14	74	0,72
1	2-1L	40	44	100	14	74	0,68
1 1/16	2-27=1 1/16L	43	44	100	16	74	0,75
1 1/8	2-1 1/8L	44	44	100	16	74	0,77
1 3/16	2-30=1 3/16L	46	44	100	17	74	0,83
1 1/4	2-1 1/4L	48,5	44	100	19	74	0,85
1 5/16	2-1 5/16L	51	44	100	19	74	1,00
1 3/8	2-35=1 3/8L	53	44	100	20	74	1,00
1 7/16	2-1 7/16L	56	44	100	21	74	1,12
1 1/2	2-38=1 1/2L	57	44	100	21	72	1,18
1 9/16	2-1 9/16L	59	44	100	22	72	1,22
1 5/8	2-1 5/8L	61	44	100	23	72	1,27
1 11/16	2-43=1 11/16L	64	44	100	24	72	1,35
1 3/4	2-1 3/4L	65	44	100	24	71	1,51
1 13/16	2-46=1 13/16L	67	44	100	25	72	1,50
1 7/8	2-1 7/8L	69	44	100	26	72	1,50
2	2-2L	71	44	100	30	72	1,39
2 9/16	2-65=2 9/16L	88	44	125	35	96	2,39
2 3/4	2-70=2 3/4L	95	44	125	40	95	2,77

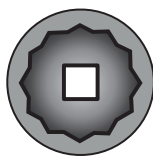
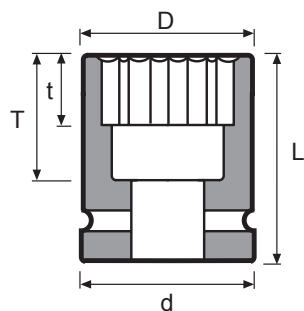



Part No	D mm	d mm	L mm	t mm	T mm	kg	
16	2-D6K16	27	44	50	10	24	0,36
17	2-D6K17	30	44	50	10	24	0,36
18	2-D6K18	31	44	50	11	24	0,36
19	2-D6K19=3/4	32	44	50	11	24	0,37
20	2-D6K20	33	44	50	12	24	0,36
21	2-D6K21	35	44	50	12	24	0,36
22	2-D6K22	35	44	50	12	24	0,38
23	2-D6K23	38	44	50	13	24	0,36
24	2-D6K24	38,5	44	50	14	24	0,38
26	2-D6K26	41	44	54	15	29	0,41
27	2-D6K27=1 1/16	42	44	54	16	29	0,41
28	2-D6K28	44	44	54	16	29	0,42
29	2-D6K29	44	44	54	17	29	0,42
30	2-D6K30=1 3/16	46	44	54	17	29	0,43
32	2-D6K32	48,5	44	56	19	30	0,48
33	2-D6K33	51	44	56	19	30	0,52
34	2-D6K34	52	44	56	20	30	0,36
35	2-D6K35=1 3/8	53	44	56	20	30	0,52
36	2-D6K36	54	44	56	20	30	0,55
37	2-D6K37	56	44	58	21	32	0,60
38	2-D6K38=1 1/2	57	44	58	21	32	0,61
41	2-D6K41	61	44	63	23	34	0,68
42	2-D6K42	62	44	63	23	34	0,75
43	2-D6K43=1 11/16	64	44	63	24	34	0,78
46	2-D6K46=1 13/16	67	44	63	25	34	0,84
47	2-D6K47	68,5	44	70	26	38	0,94
50	2-D6K50	70	44	70	28	38	1,00
55	2-D6K55	76	44	70	30	38	0,97
60	2-D6K60	83	44	80	35	50	1,32
65	2-D6K65=2 9/16	88	44	80	35	50	1,44

**Can't find what
you're looking for?**

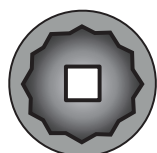
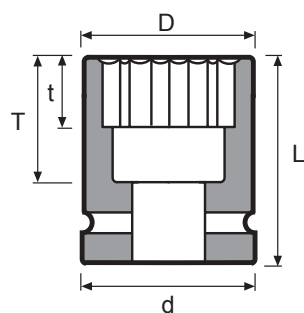
We can manufacture
special tools to meet your
individual requirements.
Contact us and we
will help you!



		Part No	D mm	d mm	L mm	t mm	T mm	 kg
5/8		2-D6K5/8	27	44	50	10	24	0,33
11/16		2-D6K11/16	30	44	50	10	24	0,36
3/4		2-D6K19=3/4	32	44	50	11	24	0,37
13/16		2-D6K13/16	35	44	50	12	24	0,37
7/8		2-D6K7/8	35	44	50	12	24	0,33
15/16		2-D6K15/16	38,5	44	50	14	24	0,37
1		2-D6K1	39	44	50	14	24	0,38
1 1/16		2-D6K27=1 1/16	42	44	54	16	29	0,41
1 1/8		2-D6K1 1/8	44	44	54	16	29	0,39
1 3/16		2-D6K30=1 3/16	46	44	54	17	29	0,43
1 1/4		2-D6K1 1/4	48,5	44	56	19	30	0,45
1 5/16		2-D6K1 5/16	51	44	56	19	30	0,50
1 3/8		2-D6K35=1 3/8	53	44	56	20	30	0,52
1 7/16		2-D6K1 7/16	56	44	58	21	32	0,58
1 1/2		2-D6K38=1 1/2	57	44	58	21	32	0,61
1 9/16		2-D6K1 9/16	59	44	58	22	32	0,65
1 5/8		2-D6K1 5/8	61	44	63	23	34	0,68
1 11/16		2-D6K43=1 11/16	64	44	63	24	34	0,78
1 3/4		2-D6K1 3/4	65	44	63	24	34	0,82
1 13/16		2-D6K46=1 13/16	67	44	63	25	34	0,84
1 7/8		2-D6K1 7/8	69	44	70	26	38	0,91
1 15/16		2-D6K1 15/16	70	44	70	28	38	0,91
2		2-D6K2	71	44	70	30	38	0,94
2 9/16		2-D6K65=2 9/16	88	44	80	35	50	1,44

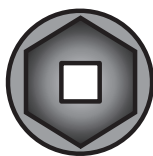
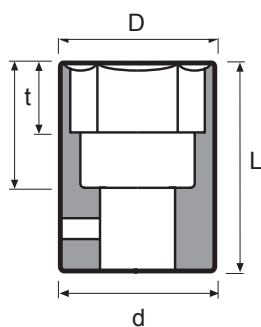

Part No	D mm	d mm	L mm	t mm	T mm	kg
T2-14	24,6	38	50	10	24	0,26
T2-16	25,8	38	50	10	24	0,22
T2-17	27,1	38	50	10	24	0,26
T2-18	28,3	38	50	11	24	0,22
T2-19=3/4	29,6	38	50	11	24	0,23
T2-20	30,8	38	50	12	24	0,30
T2-21	32,1	40	50	12	24	0,26
T2-22	33,3	40	50	12	24	0,31
T2-23	34,6	40	50	13	24	0,34
T2-24	35,8	40	50	14	24	0,36
T2-25	37,1	40	50	14	24	0,29
T2-26	38,5	40	54	15	29	0,38
T2-27=1 1/16	39,6	40	54	16	29	0,39
T2-28	40,8	44	54	16	29	0,40
T2-30=1 3/16	43,3	44	54	17	29	0,41
T2-32	45,8	44	56	19	30	0,44
T2-33	47,1	44	56	19	30	0,48
T2-36	50,8	44	56	20	30	0,52
T2-38=1 1/2	53,3	44	58	21	32	0,52
T2-41	57,1	44	63	23	34	0,65
T2-46=1 13/16	63,3	44	63	25	34	0,71
T2-50	68,3	44	70	28	38	0,93
T2-55	74,6	44	70	30	38	1,03
T2-60	80,8	44	80	35	50	1,25

 Tunnväggiga hylsor har små ytterdiametrar liknande förkromade handhylsor.

De tål därför inte lika stora påfrestningar som normala krafthylsor och bör bara användas när utrymmet är begränsat.

 Thin wall sockets have small outside diameters like hand tool sockets.

They cannot be expected to stand up to the same high loads as normal impact sockets and should only be used when limited clearance is a factor.

 Dünnwandige Steckschlüsselsätze haben kleine Auswendurchmesser ähnlich verchromten Handsteckschlüsseln.

Es kann nicht erwartet werden, dass sie die gleiche hohe Belastung wie normale Kraftsteckschlüssel aushalten. Sie sollten nur bei Platzmangel eingesetzt werden.

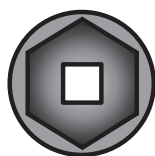
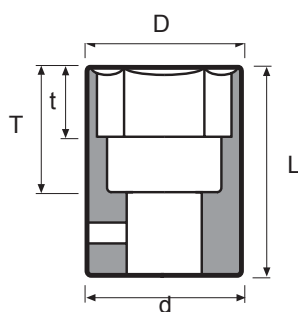
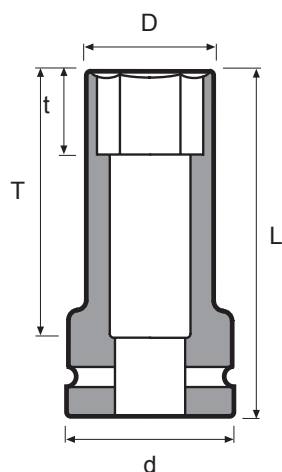

Part No	D mm	d mm	L mm	t mm	T mm	kg
17 T2-17L	27,1	44	100	10	74	0,56
18 T2-18L	28,3	44	100	11	74	0,52
19 T2-19=3/4L	29,6	44	100	11	74	0,54
20 T2-20L	30,8	44	100	12	74	0,56
21 T2-21L	32,1	44	100	12	74	0,56
22 T2-22L	33,3	44	100	12	74	0,58
23 T2-23L	34,6	44	100	13	74	0,59
24 T2-24L	35,8	44	100	14	74	0,61
26 T2-26L	38,5	44	100	15	74	0,62
27 T2-27=1 1/16L	39,6	44	100	16	74	0,67
28 T2-28L	40,8	44	100	16	74	0,70
30 T2-30=1 3/16L	43,3	44	100	17	74	0,74
32 T2-32L	45,8	44	100	19	74	0,80
33 T2-33L	47,5	44	100	19	74	0,87
36 T2-36L	50,8	44	100	20	74	0,97
41 T2-41L	57,1	44	100	23	72	1,14

3/4 T2-19=3/4	29,6	38	50	11	24	0,23
7/8 T2-7/8	33,6	40	50	12	24	0,27
1 1/16 T2-27=1 1/16	39,6	40	54	16	29	0,39
1 3/16 T2-30=1 3/16	43,3	43,3	54	17	29	0,41
1 1/4 T2-1 1/4	45,5	44	56	19	30	0,42
1 7/16 T2-1 7/16	51,5	44	58	21	32	0,52
1 1/2 T2-38=1 1/2	53,3	44	58	21	32	0,52
1 5/8 T2-1 5/8	57,5	44	63	23	34	0,52
1 13/16 T2-46=1 13/16	63,3	44	63	25	34	0,71

3/4 T2-19=3/4L	29,6	44	100	11	74	0,54
1 1/16 T2-27=1 1/16L	39,6	44	100	16	74	0,39
1 3/16 T2-30=1 3/16L	43,3	44	100	17	74	0,41

 Tunnväggiga hylsor har små ytterdiametrar liknande förkromade handhylsor.

De tål därför inte lika stora påfrestningar som normala krafthylsor och bör bara användas när utrymmet är begränsat.

 Thin wall sockets have small outside diameters like hand tool sockets.

They cannot be expected to stand up to the same high loads as normal impact sockets and should only be used when limited clearance is a factor.

 Dünnwandige Steckschlüssel-Einsätze haben kleine Auswendurchmesser ähnlich verchromten Hand-Steckschlüsseln.

Es kann nicht erwartet werden, dass sie die gleiche hohe Belastung wie normale Kraftsteckschlüssel aushalten. Sie sollten nur bei Platzmangel eingesetzt werden.

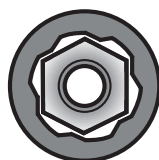
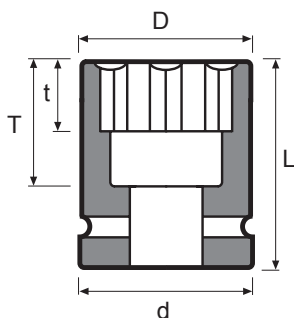

Part No	D mm	d mm	L mm	t mm	T mm	kg	
13	2-SF13	24	44	50	8	24	0,34
14	2-SF14	26	44	50	10	24	0,34
15	2-SF15	26	44	50	10	24	0,35
16	2-SF16	27	44	50	10	24	0,35
17	2-SF17	30	44	50	10	24	0,38
18	2-SF18	31	44	50	11	24	0,37
19	2-SF19=3/4	32	44	50	11	24	0,38
20	2-SF20	33	44	50	12	24	0,39
21	2-SF21	35	44	50	12	24	0,39
22	2-SF22	35	44	50	12	24	0,37
24	2-SF24	38,5	44	50	14	24	0,39
26	2-SF26	41	44	54	15	29	0,40
27	2-SF27=1 1/16	42	44	54	16	29	0,41
28	2-SF28	44	44	54	16	29	0,43
30	2-SF30=1 3/16	46	44	54	17	29	0,43
32	2-SF32	48,5	44	56	19	30	0,48
33	2-SF33	51	44	56	19	30	0,52
34	2-SF34	52	44	56	20	30	0,51
36	2-SF36	54	44	56	20	30	0,55

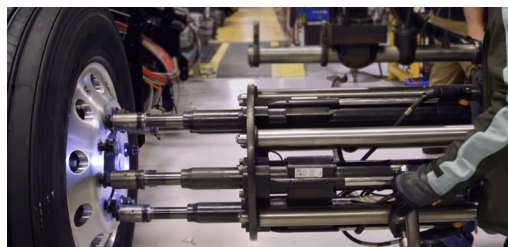

 Surface drive hylsor är avsedda för segdragande mutterdragare. De är i första hand avsedda att underlätta hylsans äntring av skruv/ mutter vid t ex montage med flerspindlig mutterdragare.

Momentos patenterade nyckelgrepp har flat kontaktyta mellan krafthylsan och muttern/skruvskallen.

 Surface drive sockets are intended for stall type nutrunners. Their primary use is to facilitate when the socket is entering the fastener, for example, mounting with a multispindle nut runner.

Momento's patented surface drive opening has flat areas of contact to the nut or bolt.

 Surface drive Steckschlüssel sind für Drehschrauber bestimmt. In erster Linie sollen sie dem Steckschlüssel die Passform der Schraube/ Mutter erleichtern, wenn sie zB mit einem mehrspindel Drehschrauber montiert werden.

Die patentierte Momento Surface-Drive-Öffnung hat flache Kontaktflächen zu Muttern und Bolzen.



 **momento**

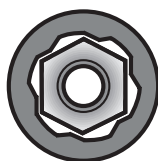
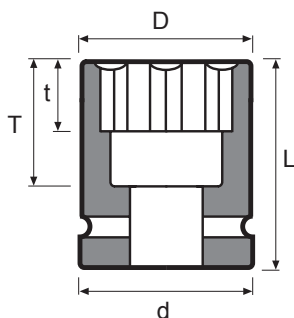

Part No	D mm	d mm	L mm	t mm	T mm	kg
13 2-SF13L	25	44	100	8	75	0,51
14 2-SF14L	27	44	100	10	75	0,55
15 2-SF15L	28	44	100	10	75	0,53
16 2-SF16L	28	44	100	10	75	0,55
17 2-SF17L	31	44	100	10	75	0,60
18 2-SF18L	32	44	100	11	75	0,64
19 2-SF19=3/4L	33	44	100	11	75	0,66
21 2-SF21L	36	44	100	12	75	0,68
22 2-SF22L	36	44	100	12	75	0,66
24 2-SF24L	39,5	44	100	14	75	0,73
27 2-SF27=1 1/16L	43	44	100	16	75	0,78
30 2-SF30=1 3/16L	46	44	100	17	75	0,86
32 2-SF32	48,5	44	100	19	75	0,90

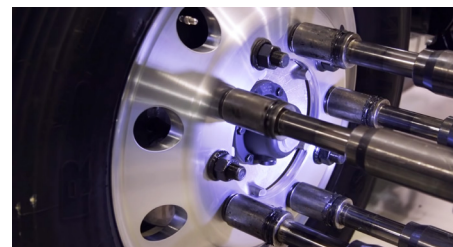
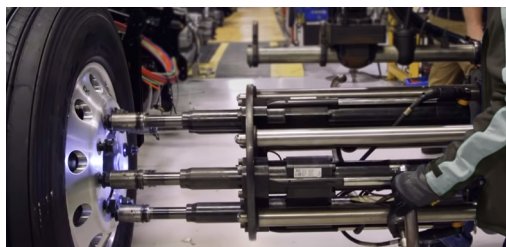

 Surface drive hylsor är avsedda för segdragande mutterdragare. De är i första hand avsedda att underlätta hylsans äntring av skruv/ mutter vid t ex montage med flerspindlig mutterdragare.

Momentos patenterade nyckelgrepp har flat kontaktyta mellan krafthylsan och muttern/skruvskallen.

 Surface drive sockets are intended for stall type nutrunners. Their primary use is to facilitate when the socket is entering the fastener, for example, mounting with a multispindle nut runner.

Momento's patented surface drive opening has flat areas of contact to the nut or bolt.

 Surface drive Steckschlüssel sind für Drehschrauber bestimmt. In erster Linie sollen sie dem Steckschlüssel die Passform der Schraube/ Mutter erleichtern, wenn sie zB mit einem mehrspindel Drehschrauber montiert werden.

Die patentierte Momento Surface-Drive-Öffnung hat flache Kontaktflächen zu Muttern und Bolzen.

Six Lobe krafthylsor

Six Lobe impact sockets

Six Lobe Kraftsteckschlüssel

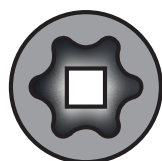
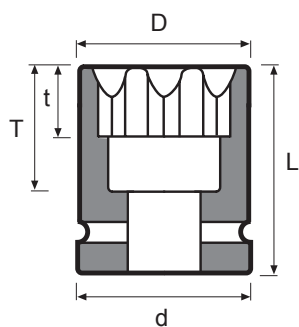

Part No	D mm	d mm	L mm	t mm	T mm	kg
E14 2-E14	19	44	50	9	24	0,32
E16 2-E16	21	44	50	11	24	0,32
E18 2-E18	24	44	50	12	24	0,33
E20 2-E20	26	44	50	13	24	0,38
E24 2-E24	32	44	54	16	28	0,40

 Passar till på marknaden vanligt förekommande skruvar med hexalobulärt grepp.

 Fits on the market commonly used screws with hexalobular driving feature.

 Passend zu den auf dem Markt gängigen Schrauben mit Innensechsrund Antrieb

Fyrkant krafthylsor

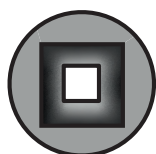
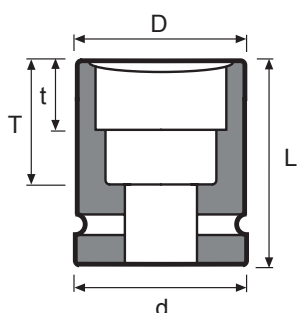

4-point impact sockets

Vierkant Kraftsteckschlüssel



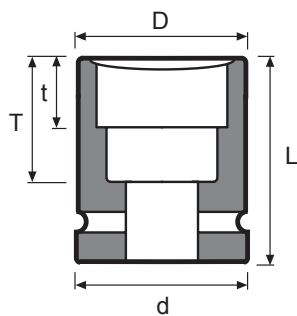

Part No	D mm	d mm	L mm	t mm	T mm	kg
13 2-4K13	25	44	60	13	35	0,27
16 2-4K16	32	44	60	16	35	0,40
17 2-4K17	35	44	60	17	35	0,40
18 2-4K18	36	44	60	18	35	0,42
19 2-4K19=3/4	38	44	60	19	35	0,43
20 2-4K20	40	44	60	20	35	0,46
21 2-4K21	42	44	60	20	35	0,48
22 2-4K22	44	44	60	20	35	0,50
23 2-4K23	46	44	60	22	34	0,51
24 2-4K24	47	44	60	22	35	0,55
25 2-4K25	51	44	60	22	34	0,55
27 2-4K27=1 1/16	52	44	60	22	33	0,55
28 2-4K28	53	44	60	22	33	0,64
30 2-4K30=1 3/16	56	44	65	25	37	0,73
32 2-4K32	58	44	65	25	37	0,76

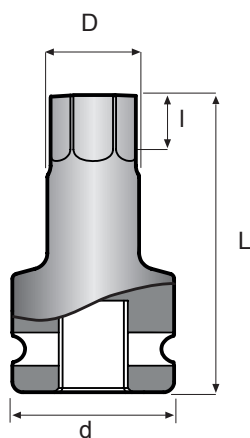
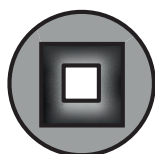

	Part No	D mm	d mm	L mm	t mm	T mm	 kg
5/8	2-4K5/8	32	44	60	16	35	0,39
11/16	2-4K11/16	35	44	60	17	35	0,41
13/16	2-4K13/16	42	44	60	20	35	0,48
7/8	2-4K7/8	44	44	60	20	35	0,41
1	2-4K1	51	44	60	22	35	0,55



		Part No	D mm	d mm	L mm	I mm	 kg
3/4	14	2-U6K14	17	44	62	10	0,31
3/4	17	2-U6K17	21	44	62	12	0,33
3/4	19	2-U6K19	23	44	62	14	0,35
3/4	22	2-U6K22	26	44	62	18	0,37
3/4	24	2-U6K24	29	54	62	20	0,57
3/4	27	2-U6K27	32	54	62	22	0,60
3/4	32	2-U6K32	38	54	62	26	0,67



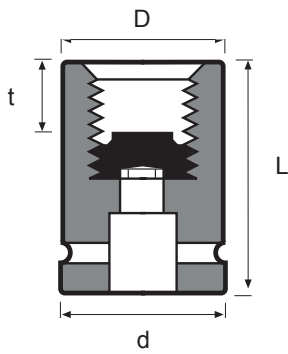

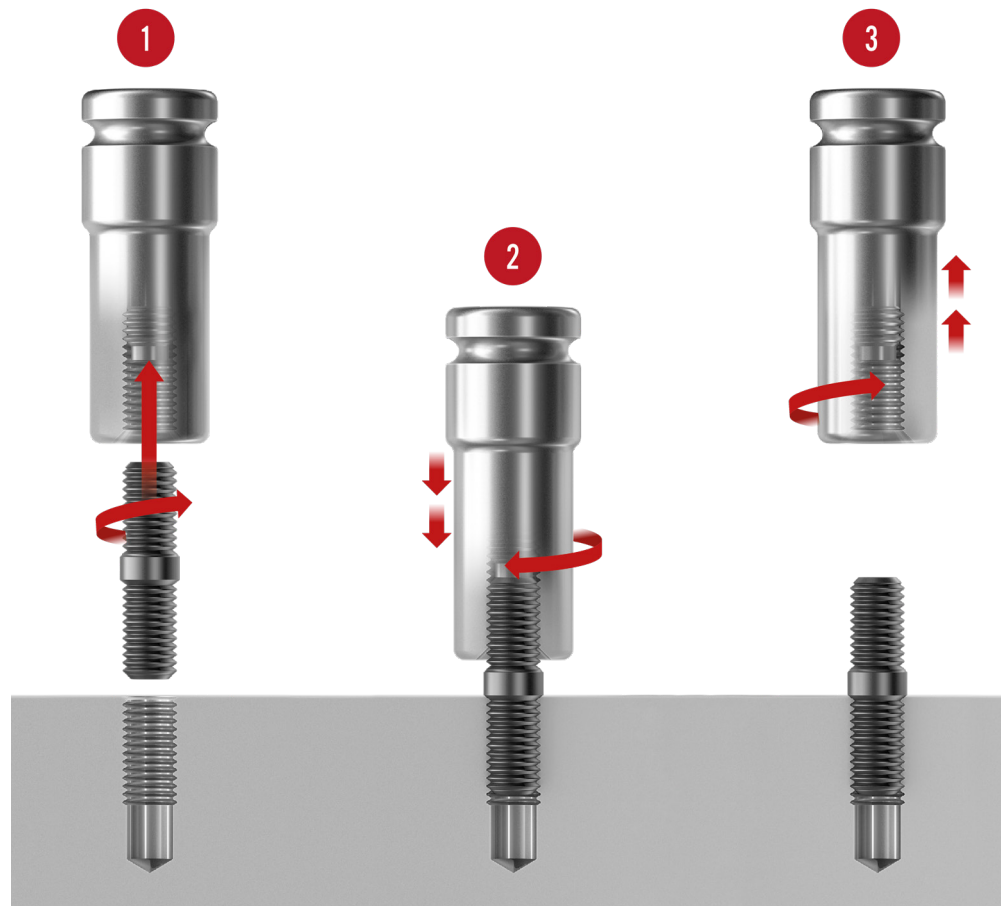

Hexagon	Part No	Stigning Pitch Steigung	D mm	d mm	L mm	t mm	kg
M14	2-M14	2	32	44	80	18	0,60
M16	2-M16	2	32	44	80	20	0,58
M18	2-M18	2,5	36	44	80	22	0,65
M20	2-M20	2,5	38	44	80	25	0,65
M22	2-M22	2,5	40	44	80	25	0,69
M24	2-M24	3	44	44	80	25	0,73
M27	2-M27	3	48	44	100	30	1,08
M30	2-M30	3,5	52	44	100	32	1,25
M33	2-M33	3,5	55	44	100	36	0,35
M36	2-M36	4	58	44	110	40	1,62
M39	2-M39	4	62	44	110	44	1,83
M42	2-M42	4,5	67	44	120	47	2,31
1/2" - 13 UNC	2-UNC1/2		30	44	80	16	0,57
5/8" - 11 UNC	2-UNC5/8		32	44	80	20	0,60
3/4" - 10 UNC	2-UNC3/4		38	44	80	22	0,66
1" - 8 UNC	2-UNC1		44	44	100	30	0,94

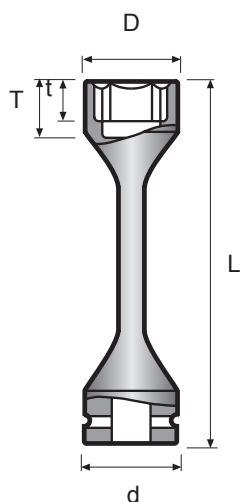

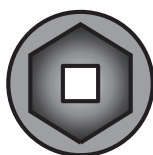

Part No	D mm	d mm	L mm	t mm	kg
24 2-24-300NM	38,5	44	305	30	1,08
27 2-27-400-NM	42,0	44	305	30	1,24
30 2-30-550NM	46,0	44	305	30	1,44
32 2-32-600NM	49,0	44	305	30	1,56
33 2-33-650NM	51	44	305	30	1,61



 Momenthylsorna är konstruerade för åtdragning av bilhjul med slående mutterdragare. Den långa och smala midjan dämpar över-skottskraften i mutterdragaren.

Det faktiska åtdragningsmomentet beror på mutterdragarens kondition och lufttrycket. Kontrollera därför regelbundet med momentnyckel.

 Torque sockets are designed for tightening wheel nuts using an impact wrench. The long and narrow waistline absorbs the excess power of the impact wrench.

The actual torque depends on the condition of the impact wrench and the pneumatic equipment. Regularly check by means of a torque wrench.

 Drehmoment-Steckschlüssel sind für das Festziehen von Radmutter mit Schlagschraubern konstruiert. Das dünne Mittelteil verhindert überschüssiges Drehmoment des Schlagschraubers.

Das tatsächliche Drehmoment hängt von der Leistung des Schlagschraubers ab. Regelmässige Kontrollen mit Drehmoment-Schlüsseln sind empfehlenswert.

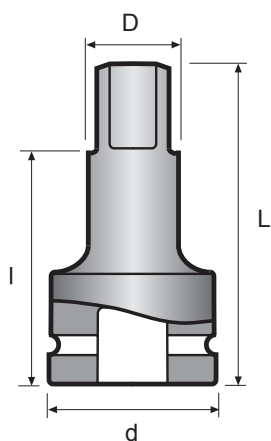

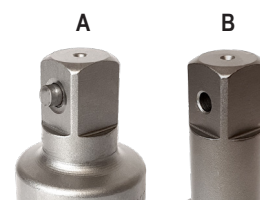

□	■	Part No	Model	D mm	d mm	L mm	I mm	kg
3/4	3/4	EB22-4	B	25,1	44	102	79	0,61
3/4	3/4	EB22-7	B	25,1	44	178	155	0,90
3/4	3/4	EB22-10	B	25,1	44	254	231	1,19
3/4	3/4	EB22-13	B	25,1	44	330	307	1,50
3/4	3/4	EB22-15	B	25,1	44	381	358	1,70
3/4	1/2	EB24-4	B	25,1	44	102	86,5	0,56
3/4	1/2	EB24-7	B	25,1	44	178	162,5	0,87
3/4	1/2	EB24-10	B	25,1	44	254	238,5	1,16
3/4	1/2	EB24-13	B	25,1	44	330	285,9	1,36
3/4	1/2	EB24-15	B	25,1	44	381	165,5	1,65

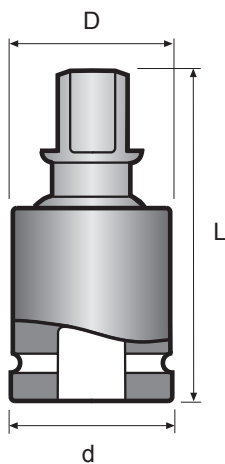

Need another size?

We can manufacture special tools to meet your individual requirements. Contact us and we will help you!



		Part No	Model	D mm	d mm	L mm	kg
3/4	3/4	UK22	B	46	44	90	0,59
3/4	3/4	UK22-IMP*	B	60	44	103	1,05

* Heavy duty version for use with impact tool

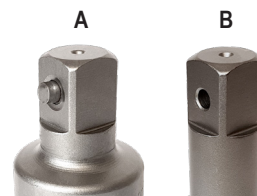

3/4"



NON-IMPACT

UK22



IMPACT

UK22-IMP

Can't find what you're looking for?

We can manufacture special tools to meet your individual requirements. Contact us and we will help you!

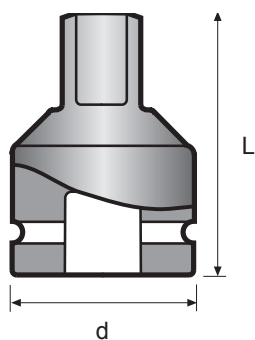

		Part No	Model	d mm	L mm	kg
3/4	1/2	PA24	A	44	52	0,29
3/4	5/8	PA28	A	44	52	0,30
3/4	1	PA29	B	44	60	0,40

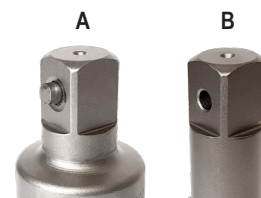

Var försiktig vid övergång till mindre fyrkant. Då mutterdragaren kan ge ett för högt vridmoment för den mindre tappen, lämnas ingen garanti.

Be careful when adapting to a smaller drive. As the power input may be too high for the smaller drive square, there is no guarantee when adapting down.

Seien Sie vorsichtig beim Übergang zu kleinen Antriebsvierkanten. Da das Drehmoment für den kleinen Vierkant zu hoch sein kann, kann keine Garantie übernommen werden.

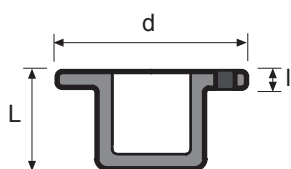
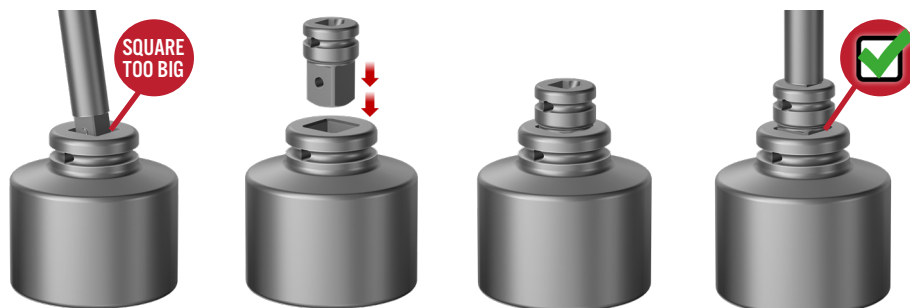

		Part No	d mm	L mm	l mm	kg
3/4	1	IPA29	54	33	5	0,16

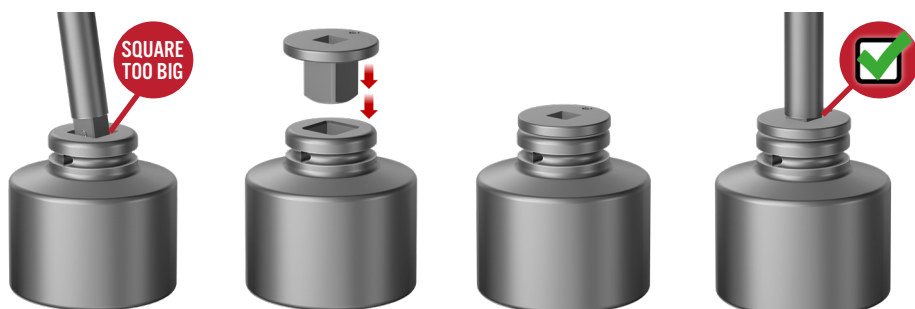

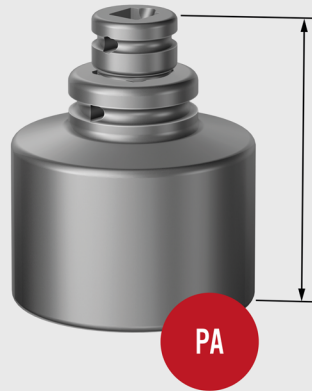
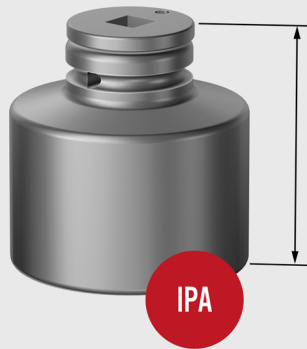
The total heightSecured with

i Info about different types of securing in the beginning of the catalogue.

The differens between IPA and PA adapters

There are some facts that you need to know to be able to pick the best adapter for your job.



- Säkras med Momento Locking, Ret ring eller Pinne och O-ring.
- Kräver större utrymme än IPA
- Secured with Momento Locking, Ret ring or Pin and O-ring.
- Requires more space than IPA
- Mit Momento Locking, Ret-Ring oder Sicherungsstifte und O-Ringe gesichert.
- Benötigt mehr Platz als IPA



- Används när utrymmet är begränsat
- Kan inte säkras med pinne och O-ring (Insatsövergången hålls kvar i hylsan med hjälp av en magnet)
- Used when space is limited
- Cannot be secured with pin and O-ring (The insert adapter sticks to the socket by means of a magnet)
- Wird verwendet, wenn der Platz begrenzt ist
- Kann nicht mit Sicherungsstifte und O-Ringe gesichert werden (Ein Magnet hält das Reduzierstück am Kraftsteckschlüssel)

Krafthylsor

Impact sockets

Kraftsteckschlüssel

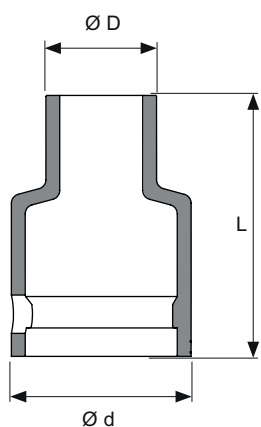

SIZE	FITS ON SOCKET	SOCKET WITH COVER	PLASTIC COVER	Ø d	Ø D	L
<i>METRIC</i>						
12	2-12	2-12RP	PC2-12	48,4	27,4	51
13	2-13	2-13RP	PC2-13	49,6	29,6	50,5
14	2-14	2-14RP	PC2-14	49,6	31,6	50,5
15	2-15	2-15RP	PC2-15	49,6	31,6	50,5
17	2-17	2-17RP	PC2-17	49,6	35,6	50,5
18	2-18	2-18RP	PC2-18	49,6	36,6	50,5
19	2-19=3/4	2-19=3/4RP	PC2-19	49,6	37,6	50,5
21	2-21	2-21RP	PC2-21	49,6	40,6	50,5
24	2-24	2-24RP	PC2-24	48,4	42,9	51

METRIC LONG

17	2-17L	2-17LRP	PC2-17L	49,6	36,6	101
19	2-19=3/4L	2-19=3/4LRP	PC2-19L	49,6	38,6	101
21	2-21L	2-21LRP	PC2-21L	49,6	41,1	101
24	2-24L	2-24LRP	PC2-24L	48,4	43,9	101

INCH

1/2	2-1/2	2-1/2RP	PC2-1/2	49,6	29,6	50,5
9/16	2-9/16	2-9/16RP	PC2-9/16	49,6	31,6	50,5
11/16	2-11/16	2-11/16RP	PC2-11/16	49,6	35,6	50,5
3/4	2-19=3/4	2-19=3/4RP	PC2-19	49,6	37,6	50,5
13/16	2-13/16	2-13/16RP	PC2-13/16	49,6	40,6	50,5
15/16	2-15/16	2-15/16RP	PC2-15/16	48,4	42,9	51

INCH LONG

11/16	2-11/16L	2-11/16LRP	PC2-11/16L	49,6	36,6	101
3/4	2-19=3/4L	2-19=3/4LRP	PC2-19L	49,6	38,6	101
13/16	2-13/16L	2-13/16LRP	PC2-13/16L	49,6	41,1	101
15/16	2-15/16L	2-15/16LRP	PC2-15/16L	48,4	43,9	101

SILVERLINE™ COVER

Read more about the plastic covers on page 21

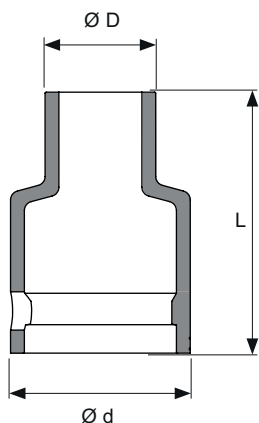

3/4"



SIZE	FITS ON SOCKET	SOCKET WITH COVER	PLASTIC COVER	Ø d	Ø D	L
<i>METRIC</i>						
17	2-D6K17	2-D6K17RP	PC2-D6K17	49,6	35,6	50,5
18	2-D6K18	2-D6K18RP	PC2-D6K18	49,6	36,6	50,5
19	2-D6K19=3/4	2-D6K19=3/4RP	PC2-D6K19	49,6	37,6	50,5
21	2-D6K21	2-D6K21RP	PC2-D6K21	49,6	40,6	50,5
24	2-D6K24	2-D6K24RP	PC2-D6K24	48,4	42,9	51

INCH

1/2"	2-D6K1/2	2-D6K1/2RP	PC2-D6K1/2	49,6	29,6	50,5
9/16"	2-D6K9/16	2-D6K9/16RP	PC2-D6K9/16	49,6	31,6	50,5
11/16"	2-D6K11/16	2-D6K11/16RP	PC2-D6K11/16	49,6	35,6	50,5
3/4"	2-D6K19=3/4	2-D6K19=3/4RP	PC2-D6K19	49,6	37,6	50,5
13/16"	2-D6K13/16	2-D6K13/16RP	PC2-D6K13/16	49,6	40,6	50,5
15/16"	2-D6K15/16	2-D6K15/16RP	PC2-D6K15/16	48,4	42,9	51

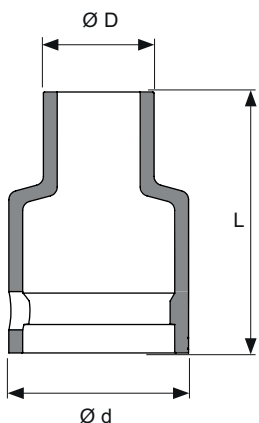

SIZE	FITS ON SOCKET	SOCKET WITH COVER	PLASTIC COVER	Ø d	Ø D	L
<i>METRIC</i>						
13	2-SF13	2-SF13RP	PC2-SF13	49,6	29,6	50,5
14	2-SF14	2-SF14RP	PC2-SF14	49,6	31,6	50,5
15	2-SF15	2-SF15RP	PC2-SF15	49,6	31,6	50,5
17	2-SF17	2-SF17RP	PC2-SF17	49,6	35,6	50,5
18	2-SF18	2-SF18RP	PC2-SF18	49,6	36,6	50,5
19	2-SF19=3/4	2-SF19=3/4RP	PC2-SF19	49,6	37,6	50,5
21	2-SF21	2-SF21RP	PC2-SF21	49,6	40,6	50,5
24	2-SF24	2-SF24RP	PC2-SF24	48,4	42,9	51

METRIC LONG

17	2-SF17L	2-SF17LRP	PC2-SF17L	49,6	36,6	101
19	2-SF19=3/4L	2-SF19=3/4LRP	PC2-SF19L	49,6	38,6	101
21	2-SF21L	2-SF21LRP	PC2-SF21L	49,6	41,1	101
24	2-SF24L	2-SF24LRP	PC2-SF24L	48,4	43,9	101

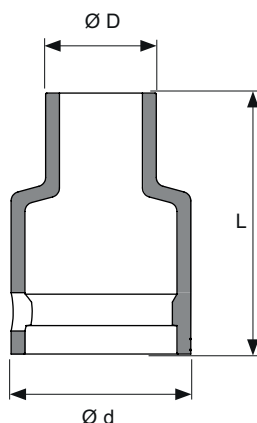

SIZE	FITS ON SOCKET	SOCKET WITH COVER	PLASTIC COVER	Ø d	Ø D	L
<i>METRIC</i>						
E18	2-E18	2-E18RP	PC2-E18	49,6	29,6	50,5
E20	2-E20	2-E20RP	PC2-E20	49,6	31,6	50,5
E22	2-E22	2-E22RP	PC2-E22	49,6	33,6	54,5
E24	2-E24	2-E24RP	PC2-E24	49,6	37,6	54,5



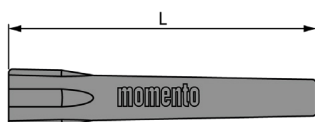

3/4"



SIZE	FITS ON SOCKET	ITEM NUMBER	L
3/4"	Fits all 3/4" sockets	P-35-3/4	35



 Elastisk Låspinne till 3/4"-hylsor med plastskydd, Silverline Cover. OBS! Skall endast användas på hylsor med Silverline Cover. Ingår i ovanstående artikelnummer för 3/4" Silverline Cover.

 Elastic locking pin for 3/4" sockets with plastic protection, Silverline Cover. N.B. Only to be used on sockets together with Silverline Cover. Included in the above part numbers for Silverline Cover.

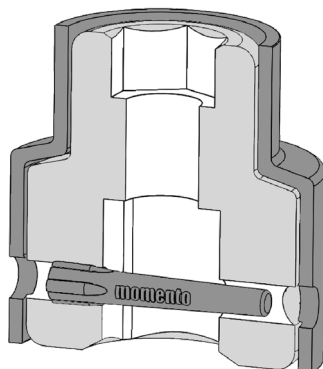

 Elastischer Sicherungsstift für 3/4" Steckschlüssel mit Kunststoffschutz, Silverline Cover. N.B. Nur zur Verwendung mit Steckschlüsseln zusammen mit Silverline Cover. In den obigen Teilenummern für Silverline Cover enthalten.



1"

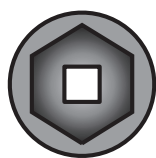
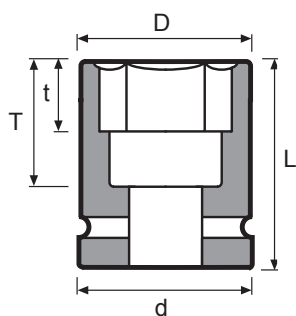



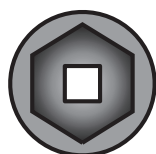
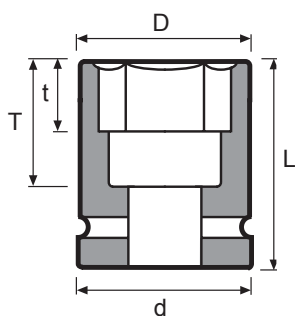

	Part No	D mm	d mm	L mm	t mm	T mm	 kg
17	9-17	33	54	59	10	30	0,63
18	9-18	34	54	59	11	30	0,63
19	9-19=3/4	35	54	59	11	27	0,63
20	9-20	36	54	59	12	30	0,62
21	9-21	36	54	59	12	27	0,67
22	9-22	37	54	59	12	27	0,66
23	9-23	38	54	59	14	27	0,64
24	9-24	38	54	59	14	27	0,62
25	9-25	41	54	59	14	30	0,64
26	9-26	43	54	59	15	27	0,63
27	9-27=1 1/16	44	54	59	16	27	0,65
28	9-28	47	54	61	16	29	0,68
29	9-29	47	54	61	17	29	0,68
30	9-30=1 3/16	50	54	61	17	29	0,69
31	9-31	50	54	61	17	32	0,67
32	9-32	52	54	61	19	29	0,68
33	9-33	54	54	61	19	29	0,69
34	9-34	54	54	61	20	29	0,67
35	9-35=1 3/8	57	54	65	20	33	0,79
36	9-36	57	54	65	20	33	0,79
37	9-37	58	54	65	21	33	0,80
38	9-38=1 1/2	59	54	65	21	33	0,82
39	9-39	59	54	65	22	34	0,74
40	9-40	61	54	65	22	34	0,80
41	9-41	63	54	70	23	38	0,95
42	9-42	64	54	70	23	38	0,97
43	9-43=1 11/16	64	54	70	24	40	0,95
44	9-44	67	54	70	24	38	1,00
45	9-45	68	54	70	25	38	1,00
46	9-46=1 13/16	69	54	75	25	42	1,12
47	9-47	71	54	75	26	43	1,18
48	9-48	72	54	75	26	43	1,20
49	9-49	73	54	75	28	46	1,16
50	9-50	75	54	80	28	48	1,36
51	9-51	76	54	80	30	51	1,38
52	9-52	78	54	80	30	48	1,45
53	9-53	79	62	83	30	54	1,79
54	9-54	80	62	83	30	54	1,78
55	9-55	81	62	83	30	50	1,74
56	9-56	82	62	83	30	52	1,78
57	9-57	85	62	83	30	54	1,88
58	9-58	86	62	83	30	54	1,84

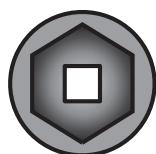
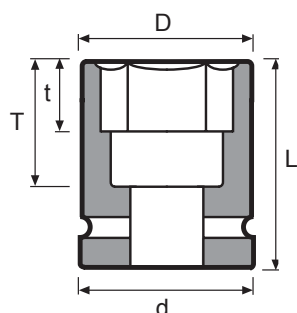

Part No	D mm	d mm	L mm	t mm	T mm	kg	
60	9-60	87	62	83	33	52	1,80
61	9-61	88	62	83	33	54	1,84
62	9-62	91	62	86	35	53	2,07
63	9-63	92	62	86	35	53	2,08
64	9-64	92	62	86	35	53	2,04
65	9-65=2 9/16	94	62	86	35	54	2,10
66	9-66	95	62	86	38	52	2,13
70	9-70=2 3/4	100	62	86	38	54	2,27
71	9-71	102	76	86	38	50	2,72
74	9-74	106	76	86	38	50	2,85
75	9-75	107	76	86	38	54	2,87
76	9-76	108	76	86	38	49	2,92
77	9-77	109	76	86	38	49	1,08
80	9-80	113	76	90	38	58	3,42
82	9-82	115	76	90	38	51	3,30
84	9-84	116	76	90	38	51	3,25
85	9-85	117	76	90	38	58	3,46
87	9-87	120	76	90	38	50	3,41
88	9-88	120	76	90	38	50	3,35
90	9-90	124	76	100	45	67	4,30
94	9-94	128	76	100	45	58	4,13
95	9-95=3 3/4	129	76	100	45	66	4,40
96	9-96	132	76	100	45	57	4,40
100	9-100	136	76	100	45	65	4,50
105	9-105=4 1/8	142	76	100	50	55	4,75
110	9-110	147	76	100	50	53	4,91
115	9-115	153	76	100	50	52	5,20
120	9-120	161	76	100	50	50	5,69
19	9-19=3/4L	36	54	100	11	71	1,30
21	9-21L	37	54	100	12	71	1,31
22	9-22L	38	54	100	12	71	0,88
23	9-23L	39	54	100	14	68	0,88
24	9-24L	39	54	100	14	68	0,89
25	9-25L	42	54	100	14	71	1,29
26	9-26L	44	54	100	15	71	0,99
27	9-27=1 1/16L	45	54	100	16	68	0,99
28	9-28L	48	54	100	16	68	1,07
29	9-29L	48	54	100	17	71	1,03
30	9-30=1 3/16L	51	54	100	17	68	1,15
31	9-31L	51	54	100	17	71	1,20
32	9-32L	53	54	100	19	68	1,17



	Part No	D mm	d mm	L mm	t mm	T mm	 kg
33	9-33L	54	54	100	19	68	1,19
34	9-34L	54	54	100	20	68	1,13
35	9-35=1 3/8L	57	54	100	20	68	1,25
36	9-36L	57	54	100	20	68	1,18
37	9-37L	58	54	100	21	68	1,26
38	9-38=1 1/2L	59	54	100	21	67	1,32
39	9-39L	59	54	100	22	69	1,30
40	9-40L	61	54	100	22	69	1,33
41	9-41L	63	54	100	23	67	1,41
42	9-42L	64	54	100	23	67	1,44
43	9-43=1 11/16L	64	54	100	24	67	1,46
44	9-44L	67	54	115	24	83	1,97
45	9-45L	68	54	115	25	83	1,98
46	9-46=1 13/16L	69	54	115	25	82	1,85
47	9-47L	71	54	115	26	83	1,93
48	9-48L	72	54	115	26	86	1,94
49	9-49L	73	54	115	28	86	1,16
50	9-50L	75	54	125	28	93	2,22
51	9-51L	76	54	125	30	96	2,26
52	9-52L	78	54	125	30	93	2,38
55	9-55L	81	62	125	30	93	2,67
56	9-56L	82	62	125	30	93	2,80
57	9-57L	85	62	125	30	96	2,80
60	9-60L	87	62	125	33	93	2,90
65	9-65=2 9/16L	94	62	135	35	105	3,63
70	9-70=2 3/4L	100	62	135	38	105	3,83
75	9-75L	107	76	135	38	105	4,80
80	9-80L	113	76	140	38	108	5,15
85	9-85L	117	76	140	38	100	5,90
90	9-90L	124	76	140	45	99	5,74
95	9-95=3 3/4L	129	76	140	45	98	5,83

**Can't find what
you're looking for?**

We can manufacture
special tools to meet your
individual requirements.
Contact us and we
will help you!

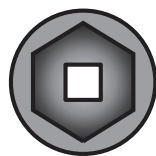
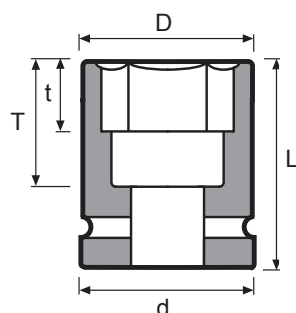

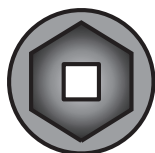
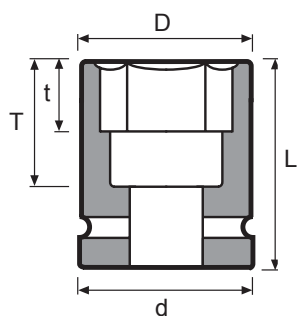

Part No	D mm	d mm	L mm	t mm	T mm	kg	
3/4	9-19=3/4	35	54	59	11	27	0,63
13/16	9-13/16	36	54	59	12	30	0,65
7/8	9-7/8	37	54	59	12	27	0,66
15/16	9-15/16	38	54	59	14	27	0,62
1	9-1	41	54	59	14	27	0,64
1 1/16	9-27=1 1/16	44	54	59	16	27	0,65
1 1/8	9-1 1/8	47	54	59	16	29	0,68
1 3/16	9-30=1 3/16	50	54	61	17	29	0,69
1 1/4	9-1 1/4	52	54	61	19	29	0,68
1 5/16	9-1 5/16	54	54	61	19	29	0,69
1 3/8	9-35=1 3/8	57	54	65	20	33	0,79
1 7/16	9-1 7/16	58	54	65	21	33	0,78
1 1/2	9-38=1 1/2	59	54	65	21	33	0,82
1 9/16	9-1 9/16	61	54	65	22	33	0,86
1 5/8	9-1 5/8	63	54	70	23	38	0,95
1 11/16	9-43=1 11/16	64	54	70	24	40	0,95
1 3/4	9-1 3/4	67	54	70	24	40	1,02
1 13/16	9-46=1 13/16	69	54	75	25	42	1,12
1 7/8	9-1 7/8	72	54	75	26	43	1,21
1 15/16	9-1 15/16	73	54	75	28	43	1,30
2	9-2	76	54	80	30	48	1,40
2 1/16	9-2 1/16	78	54	80	30	48	1,45
2 1/8	9-2 1/8	80	62	83	30	50	1,70
2 3/16	9-2 3/16	82	62	83	30	52	1,80
2 1/4	9-2 1/4	85	62	83	30	52	1,88
2 5/16	9-2 5/16	86	62	83	30	52	1,90
2 3/8	9-2 3/8	87	62	83	33	52	1,80
2 7/16	9-2 7/16	91	62	86	35	53	2,00
2 1/2	9-2 1/2	92	62	86	35	53	2,00
2 9/16	9-65=2 9/16	94	62	86	35	54	2,10
2 5/8	9-2 5/8	96	62	86	38	54	2,28
2 11/16	9-2 11/16	99	62	86	38	54	2,35
2 3/4	9-70=2 3/4	100	62	86	38	54	2,27
2 13/16	9-2 13/16	102	76	86	38	54	2,68
2 7/8	9-2 7/8	104	76	86	38	54	2,90
2 15/16	9-2 15/16	107	76	86	38	54	3,00
3	9-3	108	76	86	38	54	3,04
3 1/16	9-3 1/16	109	76	86	38	54	3,10
3 1/8	9-3 1/8	113	76	90	38	58	3,40
3 3/16	9-3 3/16	114	76	90	38	52	3,28
3 1/4	9-3 1/4	115	76	90	38	58	3,24
3 5/16	9-3 5/16	116	76	90	38	51	3,27

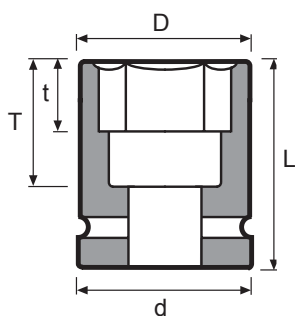

	Part No	D mm	d mm	L mm	t mm	T mm	 kg
3 3/8	9-3 3/8	117	76	90	38	58	3,40
3 7/16	9-3 7/16	120	76	90	38	50	3,37
3 1/2	9-3 1/2	122	76	90	38	57	3,60
3 5/8	9-3 5/8	126	76	100	45	66	4,05
3 3/4	9-95=3 3/4	129	76	100	45	66	4,40
3 7/8	9-3 7/8	134	76	100	45	65	4,40
4	9-4	138	76	100	45	56	4,63
4 1/8	9-105=4 1/8	142	76	100	50	55	4,75
4 5/8	9-4 5/8	157	76	100	50	51	5,43
4 3/4	9-4 3/4	161	76	100	50	50	5,73
3/4	9-19=3/4L	35	54	100	11	71	1,30
13/16	9-13/16L	37	54	100	12	71	0,86
7/8	9-7/8L	38	54	100	12	71	0,87
15/16	9-15/16L	39	54	100	14	68	0,89
1	9-1L	42	54	100	14	68	0,93
1 1/16	9-27=1 1/16L	44	54	100	16	68	0,99
1 1/8	9-1 1/8L	48	54	100	24	68	1,07
1 3/16	9-30=1 3/16L	50	54	100	17	68	1,15
1 1/4	9-1 1/4L	53	54	100	19	68	1,17
1 5/16	9-1 5/16L	54	54	100	19	68	1,19
1 3/8	9-35=1 3/8L	57	54	100	20	68	1,25
1 7/16	9-1 7/16L	58	54	100	21	68	1,31
1 1/2	9-38=1 1/2L	59	54	100	21	68	1,32
1 9/16	9-1 9/16L	61	54	100	22	67	1,38
1 5/8	9-1 5/8L	63	54	100	23	67	1,41
1 11/16	9-43=1 11/16L	64	54	100	24	67	1,46
1 3/4	9-1 3/4L	67	54	115	24	82	1,85
1 13/16	9-46=1 13/16L	69	54	115	25	82	1,85
1 7/8	9-1 7/8L	72	54	115	26	82	2,00
1 15/16	9-1 15/16L	73	54	115	28	82	2,10
2	9-2L	76	54	125	30	93	2,30
2 1/16	9-2 1/16L	78	54	125	30	93	2,40
2 1/8	9-2 1/8L	80	62	125	30	93	2,60
2 3/16	9-2 3/16L	82	62	125	30	93	2,80
2 1/4	9-2 1/4L	85	62	125	30	93	2,80
2 5/16	9-2 5/16L	86	62	125	30	93	2,90
2 3/8	9-2 3/8L	87	62	125	33	93	2,90
2 7/16	9-2 7/16L	91	62	135	35	107	3,30
2 1/2	9-2 1/2L	92	62	135	35	107	3,55
2 9/16	9-65=2 9/16L	94	62	135	35	107	3,63
2 5/8	9-2 5/8L	96	62	135	38	107	3,70



	Part No	D mm	d mm	L mm	t mm	T mm	 kg
2 11/16	9-2 11/16L	99	62	135	38	107	3,80
2 3/4	9-70=2 3/4L	100	62	135	38	107	3,83
2 13/16	9-2 13/16L	102	76	135	38	100	4,25
2 7/8	9-2 7/8L	104	76	135	38	99	4,42
2 15/16	9-2 15/16L	107	76	135	38	99	4,62
3	9-3L	108	76	135	38	98	4,82
3 1/16	9-3 1/16L	109	76	135	38	98	4,71
3 1/8	9-3 1/8L	113	76	140	38	102	5,30
3 1/4	9-3 1/4L	115	76	140	35	101	5,31
3 3/4	9-95=3 3/4L	129	76	140	45	98	5,83
3 7/8	9-3 7/8L	134	76	140	45	97	6,40





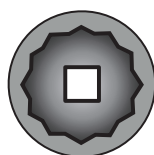
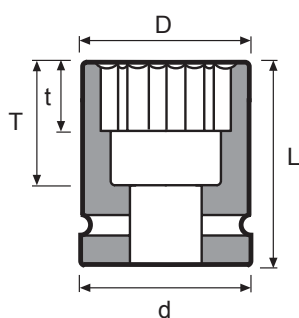



Part No	D mm	d mm	L mm	t mm	T mm	kg	
22	9-D6K22	37	54	59	12	27	0,62
24	9-D6K24	38	54	59	14	27	0,61
26	9-D6K26	43	54	59	15	27	0,63
27	9-D6K27=1 1/16	44	54	59	16	27	0,64
28	9-D6K28	47	54	61	16	29	0,68
29	9-D6K29	47	54	61	17	29	0,66
30	9-D6K30=1 3/16	50	54	61	17	29	0,68
32	9-D6K32	52	54	61	19	29	0,68
35	9-D6K35=1 3/8	57	54	65	20	33	0,79
36	9-D6K36	57	54	65	20	33	0,79
37	9-D6K37	58	54	65	21	33	0,80
38	9-D6K38=1 1/2	59	54	65	21	33	0,82
41	9-D6K41	63	54	70	23	38	0,95
42	9-D6K42	64	54	70	23	38	0,97
43	9-D6K43=1 11/16	64	54	70	24	40	0,95
46	9-D6K46=1 13/16	69	54	75	25	42	1,12
50	9-D6K50	75	54	80	28	48	1,36
55	9-D6K55	81	62	83	30	50	1,74
56	9-D6K56	82	62	83	30	52	1,78
60	9-D6K60	87	62	83	33	52	1,90
65	9-D6K65=2 9/16	94	62	86	35	54	2,26
70	9-D6K70=2 3/4	100	62	86	38	54	2,44
75	9-D6K75	107	76	86	38	54	3,02
80	9-D6K80	113	76	90	38	58	3,11

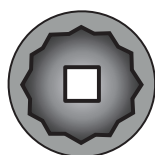
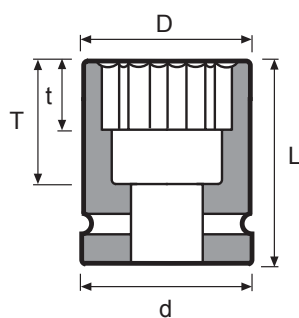



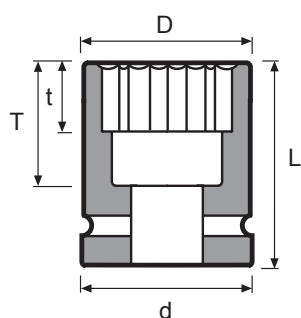

	Part No	D mm	d mm	L mm	t mm	T mm	kg
	85 9-D6K85	117	76	90	38	58	3,46
	90 9-D6K90	124	76	100	45	67	4,30
	95 9-D6K95=3 3/4	129	76	100	45	66	4,40
	100 9-D6K100	136	76	100	45	65	4,50

	Part No	D mm	d mm	L mm	t mm	T mm	kg
	7/8 9-D6K7/8	37	54	59	12	27	0,66
	15/16 9-D6K15/16	38	54	59	14	27	0,62
	1 9-D6K1	41	54	59	14	27	0,64
	1 1/16 9-D6K27=1 1/16	44	54	59	16	27	0,65
	1 1/8 9-D6K1 1/8	47	54	59	16	29	0,68
	1 3/16 9-D6K30=1 3/16	50	54	61	17	29	0,69
	1 1/4 9-D6K1 1/4	52	54	61	19	29	0,68
	1 5/16 9-D6K1 5/16	54	54	61	19	29	0,69
	1 3/8 9-D6K35=1 3/8	57	54	65	20	33	0,79
	1 7/16 9-D6K1 7/16	58	54	65	21	33	0,78
	1 1/2 9-D6K38=1 1/2	59	54	65	21	33	0,82
	1 9/16 9-D6K1 9/16	61	54	65	22	33	0,86
	1 5/8 9-D6K1 5/8	63	54	70	23	38	0,95
	1 11/16 9-D6K43=1 11/16	64	54	70	24	40	0,95
	1 3/4 9-D6K1 3/4	67	54	70	24	40	1,02
	1 13/16 9-D6K46=1 13/16	69	54	75	25	42	1,12
	1 7/8 9-D6K1 7/8	72	54	75	26	43	1,21
	1 15/16 9-D6K1 15/16	73	54	75	28	43	1,30
	2 9-D6K2	76	54	80	30	48	1,40
	2 1/16 9-D6K2 1/16	78	54	80	30	48	1,45
	2 1/8 9-D6K2 1/8	80	62	83	30	50	1,70
	2 3/16 9-D6K2 3/16	82	62	83	30	52	1,80
	2 1/4 9-D6K2 1/4	85	62	83	30	52	1,88
	2 5/16 9-D6K2 5/16	86	62	83	30	52	1,90
	2 3/8 9-D6K2 3/8	87	62	83	33	52	1,80
	2 7/16 9-D6K2 7/16	91	62	86	35	53	2,00
	2 1/2 9-D6K2 1/2	92	62	86	35	53	2,00
	2 9/16 9-D6K65=2 9/16	94	62	86	35	54	2,10
	2 5/8 9-D6K2 5/8	96	62	86	38	54	2,28
	2 11/16 9-D6K2 11/16	99	62	86	38	54	2,35
	2 3/4 9-D6K70=2 3/4	100	62	86	38	54	2,27
	2 13/16 9-D6K2 13/16	102	76	86	38	54	2,68
	2 7/8 9-D6K2 7/8	104	76	86	38	54	2,90



	Part No	D mm	d mm	L mm	t mm	T mm	 kg
2 15/16	9-D6K2 15/16	107	76	86	38	54	3,00
3	9-D6K3	108	76	86	38	54	3,04
3 1/16	9-D6K3 1/16	109	76	86	38	54	3,10
3 1/8	9-D6K3 1/8	113	76	90	38	58	3,40
3 1/4	9-D6K3 1/4	115	76	90	38	58	3,24
3 3/8	9-D6K3 3/8	117	76	90	38	58	3,40
3 1/2	9-D6K3 1/2	122	76	90	38	57	3,60
3 5/8	9-D6K3 5/8	126	76	100	45	66	4,05
3 3/4	9-D6K95=3 3/4	129	76	100	45	66	4,40
3 7/8	9-D6K3 7/8	134	76	100	45	65	4,40

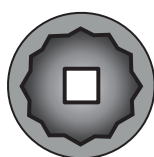



Tunnväggiga hylsor

Thin wall sockets

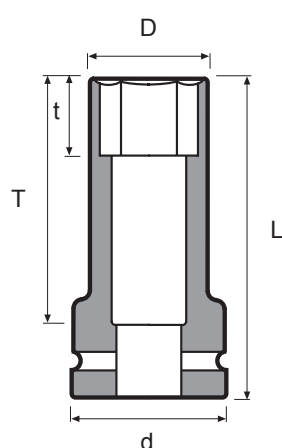
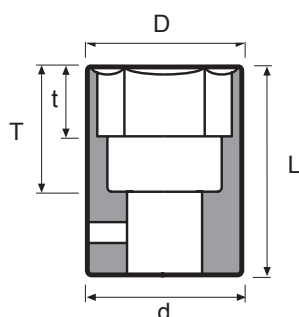

Dünnwandige steckschlüssel

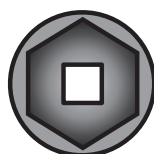

	Part No	D mm	d mm	L mm	t mm	T mm	 kg
32	T9-32	48	54	61	19	29	0,61
36	T9-36	53	54	65	20	33	0,67
38	T9-38=1 1/2	56	54	65	21	33	0,72
46	T9-46=1 13/16	66	54	75	25	42	1,01
22	T9-22L	36	54	100	12	68	0,84
24	T9-24L	38	54	100	14	68	0,84
27	T9-27=1 1/16L	41,5	54	100	16	68	0,88
30	T9-30=1 3/16L	46	54	100	17	68	0,97
32	T9-32L	48	54	100	19	68	1,00
33	T9-33L	50	54	100	19	68	1,06
36	T9-36L	53	54	100	20	68	1,12
41	T9-41L	59	54	100	23	67	1,26

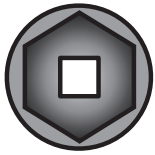
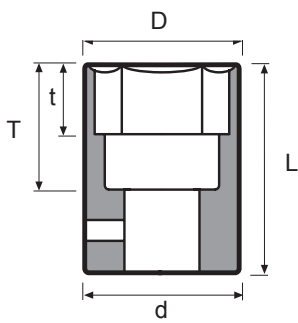



	Part No	D mm	d mm	L mm	t mm	T mm	 kg
1 1/2	T9-38=1 1/2		54	65	21	33	0,72
1 13/16	T9-46=1 13/16	66	54	75	25	42	1,01
1 1/16	T9-27=1 1/16L	41,5	54	100	16	68	0,88
1 3/16	T9-30=1 3/16L	46	54	100	17	68	0,97



Tunnväggiga hylsor har små ytterdiametrar liknande förkromade handhylsor.

De tål därför inte lika stora påfrestningar som normala krafthylsor och bör bara användas när utrymmet är begränsat.



Thin wall sockets have small outside diameters like hand tool sockets.

They cannot be expected to stand up to the same high loads as normal impact sockets and should only be used when limited clearance is a factor.



Dünnwandige Steckschlüssel-Einsätze haben kleine Auswendurchmesser ähnlich verchromten Hand Steckschlüsseln.

Es kann nicht erwartet werden, dass sie die gleiche hohe Belastung wie normale Kraftsteckschlüssel aushalten. Sie sollten nur bei Platzmangel eingesetzt werden.

Can't find what you're looking for?

We can manufacture special tools to meet your individual requirements. Contact us and we will help you!

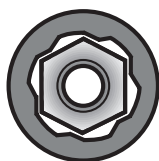
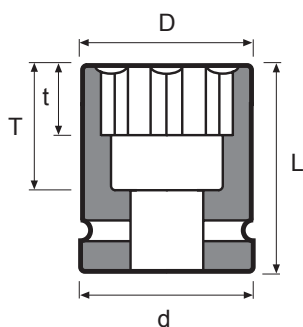

Part No	D mm	d mm	L mm	t mm	T mm	kg
18 9-SF18	34	54	59	11	27	0,61
19 9-SF19=3/4	35	54	59	11	27	0,63
21 9-SF21	36	54	59	12	27	0,62
22 9-SF22	37	54	59	12	27	0,63
24 9-SF24	38	54	59	14	29	0,62
27 9-SF27=1 1/16	44	54	59	16	29	0,65
30 9-SF30=1 3/16	50	54	61	17	31	0,69
32 9-SF32	52	54	61	19	31	0,65
33 9-SF33	54	54	61	19	31	0,68
34 9-SF34	54	54	61	20	27	0,65
36 9-SF36	57	54	65	20	35	0,77
24 9-SF24L	39	54	100	15	70	0,90
27 9-SF27=1 1/16L	44	54	100	16	70	0,97
30 9-SF30=1 3/16L	50	54	100	17	70	1,15
32 9-SF32L	52,5	54	100	19	70	1,19



 Surface drive hylsor är avsedda för segdragande mutterdragare. De är i första hand avsedda att underlätta hylsans äntring av skruv/ mutter vid t ex montage med flerspindlig mutterdragare.

Momentos patenterade nyckelgrepp har flat kontaktyta mellan krafthylsan och muttern/skruvskallen.

 Surface drive sockets are intended for stall type nutrunners. Their primary use is to facilitate when the socket is entering the fastener, for example, mounting with a multispindle nut runner.

Momento's patented surface drive opening has flat areas of contact to the nut or bolt.

 Surface drive Steckschlüssel sind für Drehschrauber bestimmt. In erster Linie sollen sie dem Steckschlüssel die Passform der Schraube/ Mutter erleichtern, wenn sie zB mit einem mehrspindel Drehschrauber montiert werden.

Die patentierte Momento Surface-Drive-Öffnung hat flache Kontaktflächen zu Muttern und Bolzen.

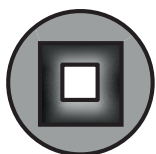
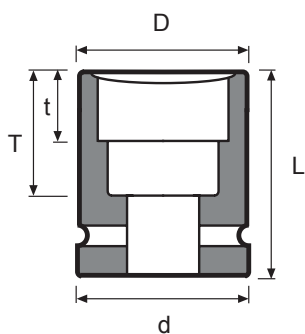

Part No	D mm	d mm	L mm	t mm	T mm	kg
16 9-4K16	35	54	64	16	34	0,63
17 9-4K17	36	54	64	17	32	0,63
18 9-4K18	38	54	64	18	34	0,63
19 9-4K19=3/4	40	54	64	19	32	0,65
20 9-4K20	42	54	64	20	32	0,69
21 9-4K21	44	54	64	20	32	0,69
22 9-4K22	46	54	64	20	32	0,70
24 9-4K24	52	54	70	35	38	0,84
25 9-4K25	53	54	70	37	40	0,84
27 9-4K27=1 1/16	54	54	70	40	40	0,85
28 9-4K28	57	54	70	25	40	0,93
29 9-4K29	57	54	75	25	45	0,93
30 9-4K30=1 3/16	58	54	75	30	44	0,97
32 9-4K32	62	54	75	30	44	1,06
33 9-4K33	64	54	75	30	43	1,21
35 9-4K35=1 3/8	67	54	75	30	43	1,19
36 9-4K36	69	54	75	30	43	1,25
38 9-4K38=1 1/2	72	54	75	30	43	1,32
40 9-4K40	76	54	80	35	47	1,56
41 9-4K41	78	54	80	35	47	1,63
42 9-4K42	80	62	80	35	46	1,87
46 9-4K46=1 13/16	86	62	80	35	45	2,05
5/8 9-4K5/8	35	54	64	16	34	0,62
1 9-4K1	53	54	70	22	40	0,84

Need another size?

We can manufacture special tools to meet your individual requirements. Contact us and we will help you!

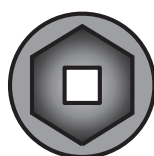
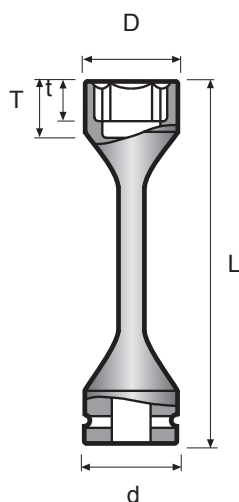

Part No	D mm	d mm	L mm	t mm	T mm	kg
24 9-24-300NM	40	54	305	27	48	1,02
27 9-27-350NM	46	54	305	27	48	1,24
27 9-27-400NM	46	54	305	27	48	1,28
30 9-30-450NM	49	54	305	27	48	1,39
30 9-30-550NM	49	54	305	27	48	1,46
32 9-32-500NM	53	54	305	27	48	1,71
32 9-32-600NM	53	54	305	27	48	1,76
32 9-32-650NM	53	54	305	27	48	1,84
32 9-32-700NM	53	54	305	27	48	1,85
33 9-33-500NM	54	54	305	27	48	1,70
33 9-33-600NM	54	54	305	27	48	1,82
33 9-33-650NM	54	54	305	27	48	1,87
33 9-33-700NM	54	54	305	27	48	1,90
1 5/16 9-1 5/16-650NM	54	54	305	27	48	1,83



Momenthylsorna är konstruerade för åtdragning av bilhjul med slående mutterdragare. Den långa och smala midjan dämpar över-skottskraften i mutterdragaren.

Det faktiska åtdragningsmomentet beror på mutterdragarens kondition och lufttrycket. Kontrollera därför regelbundet med momentnyckel.



Torque sockets are designed for tightening wheel nuts using an impact wrench. The long and narrow waistline absorbs the excess power of the impact wrench.

The actual torque depends on the condition of the impact wrench and the pneumatic equipment. Regularly check by means of a torque wrench.





Drehmoment-Steckschlüssel sind für das Festziehen von Radmutter mit Schlagschraubern konstruiert. Das dünne Mittelteil verhindert überschüssiges Drehmoment des Schlagschraubers.

Das tatsächliche Drehmoment hängt von der Leistung des Schlagschraubers ab. Regelmäßige Kontrollen mit Drehmoment-Schlüsseln sind empfehlenswert.

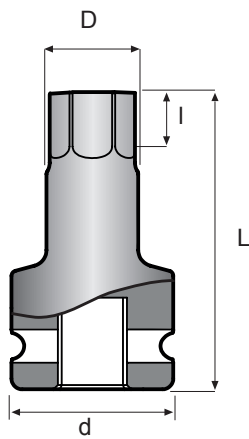



			Part No	D mm	d mm	L mm	l mm		kg
1	17	9-U6K17	21	54	75	12	0,59		
1	19	9-U6K19	23	54	75	14	0,60		
1	22	9-U6K22	26	54	75	18	0,63		
1	24	9-U6K24	29	54	75	20	0,65		
1	27	9-U6K27	32	54	75	22	0,69		
1	30	9-U6K30	36	62	75	24	0,96		
1	32	9-U6K32	38	62	75	26	0,99		
1	36	9-U6K36	42	62	75	30	1,06		

Can't find what
you're looking for?

We can manufacture
special tools to meet your
individual requirements.
Contact us and we
will help you!

Specialhylsor för lastbilsservice
Långa midjehylsor för fjäderbygel

Special sockets for truck service
Long sockets for suspension frame

Spezialsteckschlüssel für LKW-Service
Lange Steckschlüssel für Federbügel

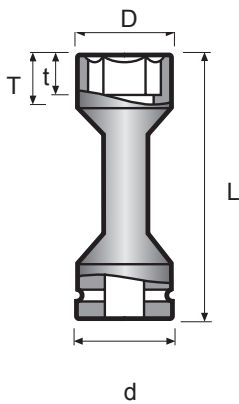

		Part No	D mm	d mm	L mm	t mm	T mm		kg
24	9-24LS	41	54	170	30	43	1,27		
27	9-27LS	44	54	170	30	43	1,28		
30	9-30LS	49	54	170	30	43	1,40		
32	9-32LS	52	54	170	30	43	1,47		
33	9-33LS	53	54	170	30	43	1,49		
34	9-34LS	54	54	170	30	43	1,52		
36	9-36LS	56	54	170	30	43	1,54		



Specialhylsor för lastbilsservice
För portabla, elektriska, slående mutterdragare

Special sockets for truck service
For portable, electrical, impact wrenches

Spezialsteckschlüssel für LKW-Service
Für fahrbare elektrische Schlagschrauber

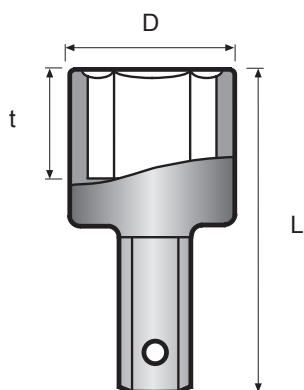

Part No	D mm	d mm	L mm	t mm	T mm	kg
9-24E	42	33,5	105	27	33	0,62
9-27=1 1/16E	47	33,5	110	27	35	0,72
9-30=1 3/16E	51,5	33,5	118	32	43	0,85
9-32E	54	33,5	118	32	43	0,93
9-33E	54	33,5	118	32	43	0,90
9-34E	54	33,5	118	32	43	0,90
9-36E	58	33,5	125	34	45	1,04
9-38=1 1/2E	58	33,5	125	34	45	1,00
9-32EL	54	33,5	155	32	80	1,43
9-33EL	54	33,5	155	32	80	1,43

Specialhylsor för lastbilsservice
Övergång för användning av standardhylsor

Special sockets for truck service
Adapters enabling the use of
standard impact sockets

Spezialsteckschlüssel für LKW-Service
Übergangsstücke ermöglichen den
Einsatz normaler Kraftsteckschlüssel

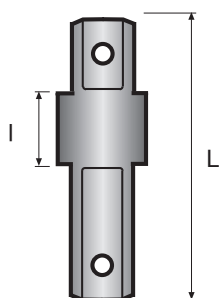

Part No	d mm	L mm	kg
1 PA99E	33,5	125	0,66
3/4 PA92E	33,5	120	0,57



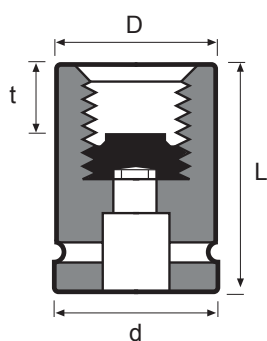

⊙	Part No	Stigning Pitch Steigung	D mm	d mm	L mm	t mm	kg	
	M20	9-M20	2,5	42	54	100	25	0,96
	M22	9-M22	2,5	42	54	100	25	1,05
	M24	9-M24	3	44	54	100	25	1,07
	M27	9-M27	3	48	54	100	28	1,19
	M30	9-M30	3,5	52	54	100	30	1,30
	M33	9-M33	3,5	57	54	110	38	1,63
	M36	9-M36	4	60	54	110	40	1,79
	M39	9-M39	4	65	54	110	44	2,00
	M42	9-M42	4,5	68	54	115	47	2,25
	M48	9-M48	5	74	54	115	50	2,51

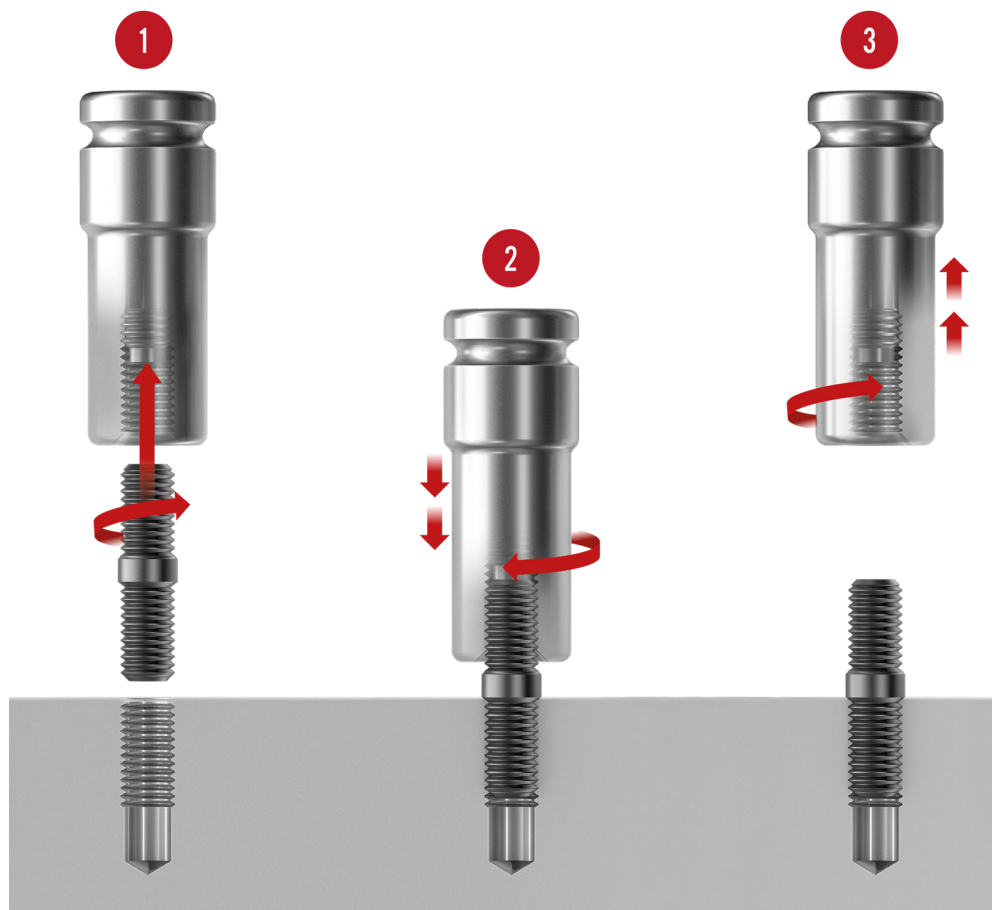

Förlängare

Extensions

Verlängerungen

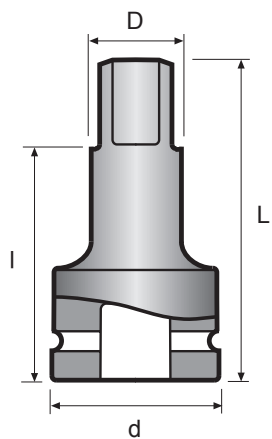

□	■	Artikel nr	Model	D mm	d mm	L mm	l mm	kg
1	1	EB99-4	B	33,5	54	102	74	0,95
1	1	EB99-7	B	33,5	54	178	150	1,46
1	1	EB99-10	B	33,5	54	254	226	2,00
1	1	EB99-13	B	33,5	54	330	302	2,50
1	1	EB99-15	B	33,5	54	381	353	2,85

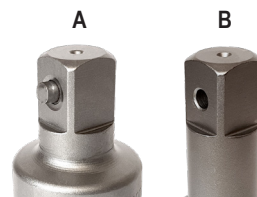

Universalknutar

Universal joints

Kugelgelenke

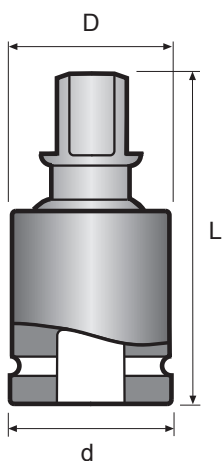

□	■	Part No	Model	D mm	d mm	L mm	kg
1	1	UK99	B	60	54	113	1,22

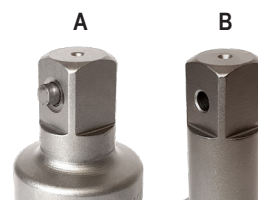

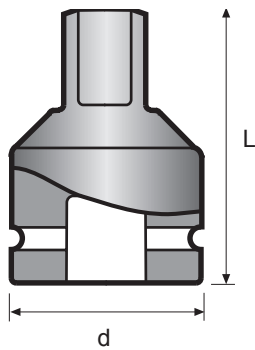

□	■	Part No	Model	d mm	L mm	kg
1	3/4	PA92	B	54	67	0,53
1	1 1/4	PA93	B	64	82	1,12
1	1 1/2	PA95	B	64	85	1,26

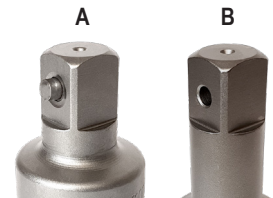

Var försiktig vid övergång till mindre fyrkant. Då mutterdragaren kan ge ett för högt vridmoment för den mindre tappen, lämnas ingen garanti.

Be careful when adapting to a smaller drive. As the power input may be too high for the smaller drive square, there is no guarantee when adapting down.

Seien Sie vorsichtig beim Übergang zu kleinen Antriebsvierkanten. Da das Drehmoment für den kleinen Vierkant zu hoch sein kann, kann keine Garantie übernommen werden.

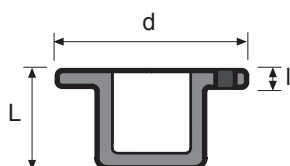
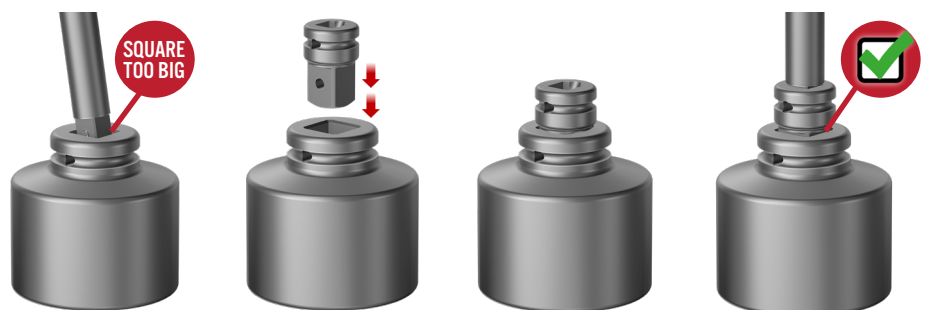

□	■	Artikel nr	d mm	L mm	l mm	kg
1	1 1/2	IPA95	84	45	6	0,53

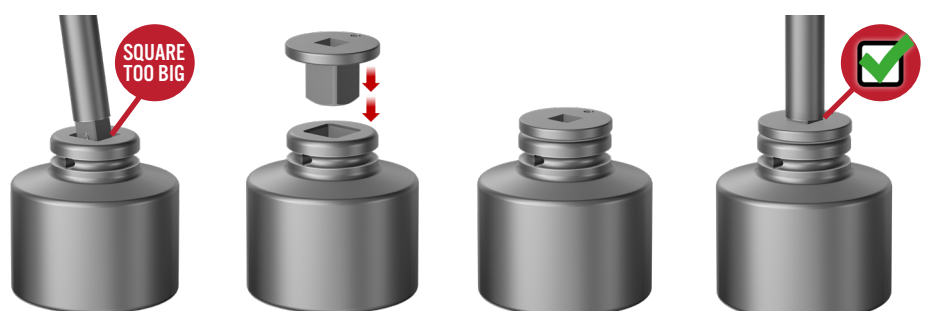

The total height

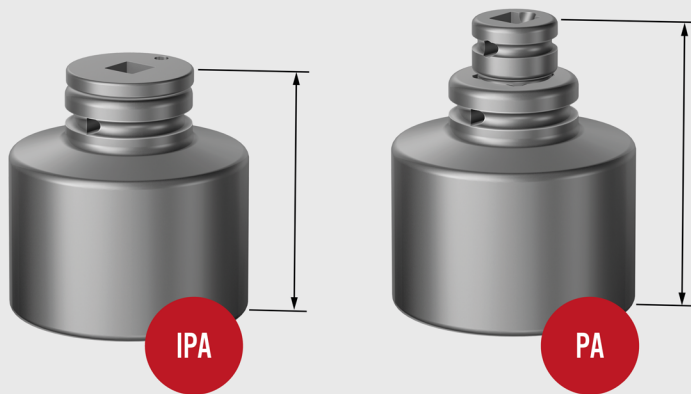

Secured with

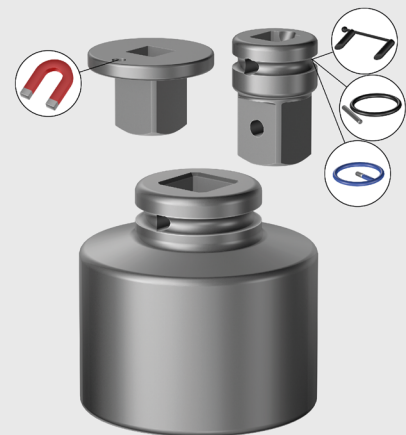

i Info about different types of securing in the beginning of the catalogue.

The differens between IPA and PA adapters

There are some facts that you need to know to be able to pick the best adapter for your job.



- Säkras med Momento Locking, Ret ring eller Pinne och O-ring.
- Kräver större utrymme än IPA
- Secured with Momento Locking, Ret ring or Pin and O-ring.
- Requires more space than IPA
- Mit Momento Locking, Ret-Ring oder Sicherungsstifte und O-Ringe gesichert.
- Benötigt mehr Platz als IPA





- Används när utrymmet är begränsat
- Kan inte säkras med pinne och O-ring (Insatsövergången hålls kvar i hylsan med hjälp av en magnet)
- Used when space is limited
- Cannot be secured with pin and O-ring (The insert adapter sticks to the socket by means of a magnet)
- Wird verwendet, wenn der Platz begrenzt ist
- Kann nicht mit Sicherungsstifte und O-Ringe gesichert werden (Ein Magnet hält das Reduzierstück am Kraftsteckschlüssel)

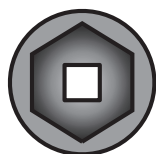
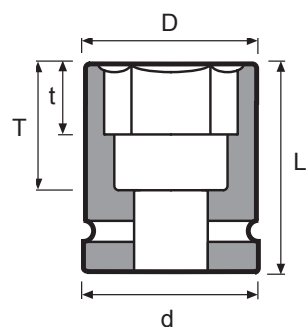

1 1/2"



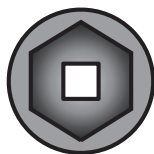
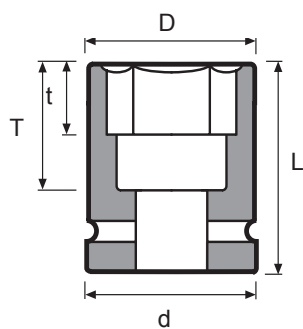

	Part No	D mm	d mm	L mm	t mm	T mm	 kg
22	5-22	46	84	80	14	38	1,95
24	5-24	48	84	80	14	38	1,96
25	5-25	50	84	80	14	38	2,00
27	5-27=1 1/16	54	84	80	16	38	2,07
30	5-30=1 3/16	56	84	80	17	38	2,07
32	5-32	59	84	80	19	38	2,13
33	5-33	59	84	80	19	38	2,13
34	5-34	61	84	80	20	38	2,15
35	5-35=1 3/8	61	84	80	20	36	2,10
36	5-36	63	84	84	21	36	2,30
37	5-37	65	84	84	21	42	2,19
38	5-38=1 1/2	65	84	84	21	36	2,30
41	5-41	70	84	84	23	36	2,29
42	5-42	71	84	84	23	36	2,26
43	5-43=1 11/16	73	84	84	24	36	2,40
46	5-46=1 13/16	76	84	87	25	40	2,40
47	5-47	78	84	87	26	40	2,40
48	5-48	79	84	87	26	40	2,40
50	5-50	81	84	90	28	43	2,40
52	5-52	83	84	90	30	43	2,50
54	5-54	84	84	90	30	44	2,38
55	5-55	86	86	90	30	47	2,52
56	5-56	87	86	95	30	51	2,90
57	5-57	90	86	95	30	53	2,90
58	5-58	92	86	95	30	53	2,97
60	5-60	94	86	95	35	51	3,03
63	5-63	97	86	100	35	58	3,16
64	5-64	97	86	100	35	58	3,24
65	5-65=2 9/16	99	86	100	35	56	3,38
70	5-70=2 3/4	105	86	105	40	61	4,00
75	5-75	112	86	110	42	66	4,60
77	5-77	118	86	110	42	60	5,00
80	5-80	119	86	110	42	66	5,30
85	5-85	125	86	120	50	75	5,67
90	5-90	131	86	120	50	75	6,04
95	5-95=3 3/4	141	102	130	55	83	8,30
100	5-100	146	102	130	55	83	8,63
105	5-105=4 1/8	151	102	130	55	83	9,40





	Part No	D mm	d mm	L mm	t mm	T mm	 kg
110	5-110	157	102	140	70	92	10,00
115	5-115	163	102	140	72	92	10,60
120	5-120	170	102	140	77	90	11,20
125	5-125	175	102	140	77	90	11,80
130	5-130	180	102	150	80	100	12,90
135	5-135	186	102	150	80	100	13,60
140	5-140	192	102	150	80	100	15,00
145	5-145	198	102	150	80	97	17,20
150	5-150	203	102	150	85	97	18,00
155	5-155	209	102	150	85	97	19,00

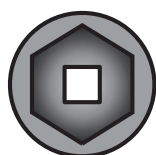
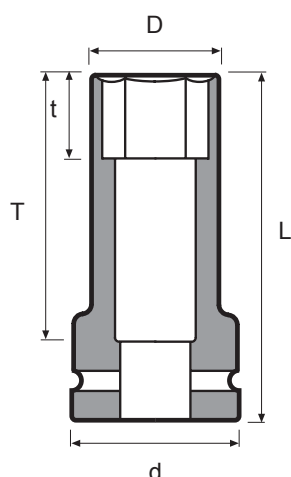

Can't find what you're looking for?

We can manufacture special tools to meet your individual requirements. Contact us and we will help you!

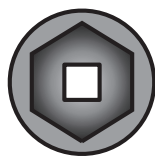
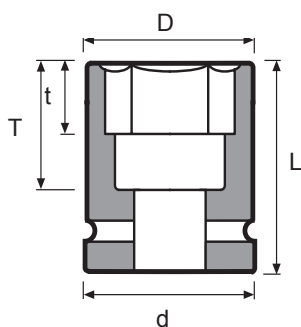

	Part No	D mm	d mm	L mm	t mm	T mm	 kg
30	5-30=1 3/16L	56	84	150	17	108	3,30
35	5-35=1 3/8L	61	84	150	20	108	3,79
36	5-36L	63	84	150	23	108	3,81
38	5-38=1 1/2L	65	84	150	24	108	3,86
41	5-41L	70	84	150	27	106	3,70
42	5-42L	71	84	150	27	106	3,70
43	5-43=1 11/16L	73	84	150	27	106	3,90
46	5-46=1 13/16L	77	84	150	29	106	3,90
47	5-47L	78	84	150	30	106	4,26
48	5-48L	79	84	150	30	105	4,18
50	5-50L	81	84	150	32	106	3,90
52	5-52L	83	84	150	33	106	3,90
55	5-55L	86	86	150	35	106	4,10
56	5-56L	87	86	150	35	108	4,18
57	5-57L	90	86	150	36	108	4,40
58	5-58L	92	86	150	37	108	4,70
60	5-60L	94	86	150	39	106	4,70
63	5-63L	97	86	150	41	108	4,94
64	5-64L	97	86	150	41	108	4,86
65	5-65=2 9/16L	99	86	150	41	106	4,90
70	5-70=2 3/4L	105	86	170	45	126	6,40
75	5-75L	112	86	170	47	126	6,90
80	5-80L	119	86	170	51	126	7,60
85	5-85L	125	86	180	54	135	9,40
90	5-90L	131	86	180	58	135	10,00
95	5-95=3 3/4L	141	102	190	61	143	12,10
100	5-100L	146	102	190	46	143	12,60
105	5-105=4 1/8L	151	102	190	66	143	13,20
110	5-110L	157	102	200	70	152	14,50
115	5-115L	163	102	200	72	152	15,10
120	5-120L	170	102	200	77	150	16,00
125	5-125L	175	102	200	77	136	17,12
130	5-130L	180	102	210	80	145	18,59
135	5-135L	186	102	210	80	144	19,50
140	5-140L	192	102	210	80	142	20,80
145	5-145L	198	102	210	80	141	21,74
150	5-150L	203	102	210	85	139	22,33
155	5-155L	209	102	210	85	138	23,35





		Part No	D mm	d mm	L mm	t mm	T mm	 kg
	1	5-1	50	84	80	14	38	1,98
	1 1/16	5-27=1 1/16	54	84	80	16	38	2,07
	1 1/8	5-1 1/8	54	84	80	16	38	1,98
	1 3/16	5-30=1 3/16	56	84	80	17	38	2,07
	1 1/4	5-1 1/4	59	84	80	19	38	2,15
	1 5/16	5-1 5/16	59	84	80	19	38	1,98
	1 3/8	5-35=1 3/8	61	84	80	20	36	2,10
	1 7/16	5-1 7/16	63	84	84	21	42	2,17
	1 1/2	5-38=1 1/2	65	84	84	21	36	2,30
	1 9/16	5-1 9/16	68	84	84	22	42	2,25
	1 5/8	5-1 5/8	70	84	84	23	36	2,40
	1 11/16	5-43=1 11/16	73	84	84	24	36	2,40
	1 3/4	5-1 3/4	75	84	87	25	40	2,40
	1 13/16	5-46=1 13/16	76	84	87	25	40	2,40
	1 7/8	5-1 7/8	78	84	87	26	40	2,40
	1 15/16	5-1 15/16	80	84	90	28	43	2,40
	2	5-2	82	84	90	30	43	2,42
	2 1/16	5-2 1/16	83	84	90	30	43	2,50
	2 1/8	5-2 1/8	84	84	90	30	43	2,60
	2 3/16	5-2 3/16	87	86	95	30	51	2,90
	2 1/4	5-2 1/4	90	86	95	30	51	2,90
	2 5/16	5-2 5/16	92	86	95	30	51	3,00
	2 3/8	5-2 3/8	94	86	95	35	51	3,10
	2 7/16	5-2 7/16	96	86	100	35	56	3,30
	2 1/2	5-2 1/2	97	86	100	35	56	3,30
	2 9/16	5-65=2 9/16	99	86	100	35	56	3,38
	2 5/8	5-2 5/8	102	86	105	40	61	3,80
	2 11/16	5-2 11/16	104	86	105	40	61	3,90
	2 3/4	5-70=2 3/4	105	86	105	40	61	4,00
	2 13/16	5-2 13/16	107	86	110	42	66	4,20
	2 7/8	5-2 7/8	110	86	110	42	66	4,40
	2 15/16	5-2 15/16	112	86	110	42	66	4,60
	3	5-3	116	86	110	42	66	4,90
	3 1/16	5-3 1/16	118	86	110	42	66	5,10
	3 1/8	5-3 1/8	119	86	110	42	66	5,40

**Can't find what
you're looking for?**

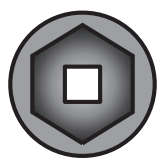
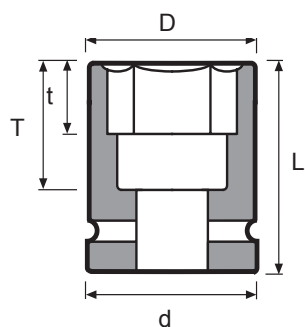
We can manufacture
special tools to meet your
individual requirements.
Contact us and we
will help you!



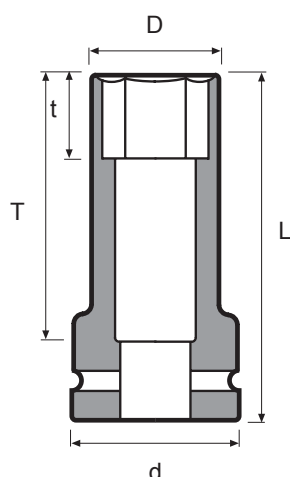

	Part No	D mm	d mm	L mm	t mm	T mm		kg
3 3/16	5-3 3/16	121	86	120	50	75		5,70
3 1/4	5-3 1/4	123	86	120	50	75		6,00
3 5/16	5-3 5/16	125	86	120	50	68		6,01
3 3/8	5-3 3/8	125	86	120	50	75		6,20
3 7/16	5-3 7/16	129	86	120	50	67		6,26
3 1/2	5-3 1/2	130	86	120	50	75		6,70
3 9/16	5-3 9/16	131	86	120	50	67		6,34
3 5/8	5-3 5/8	136	102	120	50	75		7,00
3 11/16	5-3 11/16	138	102	120	50	66		7,35
3 3/4	5-95=3 3/4	141	102	130	55	83		8,30
3 13/16	5-3 13/16	142	102	130	55	75		8,29
3 7/8	5-3 7/8	144	102	130	55	83		8,48
3 15/16	5-3 15/16	146	102	130	55	83		9,00
4	5-4	148	102	130	55	83		9,10
4 1/16	5-4 1/16	149	102	130	55	73		8,80
4 1/8	5-105=4 1/8	151	102	130	55	83		9,40
4 3/16	5-4 3/16	153	102	130	55	83		9,60
4 1/4	5-4 1/4	155	102	140	70	92		9,97
4 5/16	5-4 5/16	157	102	140	70	81		10,14
4 3/8	5-4 3/8	158	102	140	70	92		10,30
4 1/2	5-4 1/2	163	102	140	72	92		10,67
4 5/8	5-4 5/8	166	102	140	77	90		10,82
4 3/4	5-4 3/4	170	102	140	77	90		11,10
4 7/8	5-4 7/8	173	102	140	77	90		11,50
5	5-5	178	102	150	77	100		12,30
5 1/8	5-5 1/8	180	102	150	80	100		12,90
5 3/16	5-5 3/16	182	102	150	80	100		13,10
5 1/4	5-5 1/4	185	102	150	80	100		13,40
5 3/8	5-5 3/8	188	102	150	80	100		14,00
5 1/2	5-5 1/2	192	102	150	80	100		15,00
5 9/16	5-5 9/16	193	102	150	80	97		15,90
5 3/4	5-5 3/4	199	102	150	85	97		17,40
5 7/8	5-5 7/8	203	102	150	85	97		18,20
6	5-6	206	102	150	85	97		15,45
6 1/8	5-6 1/8	209	102	150	85	97		19,00

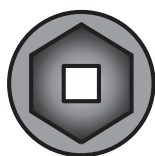
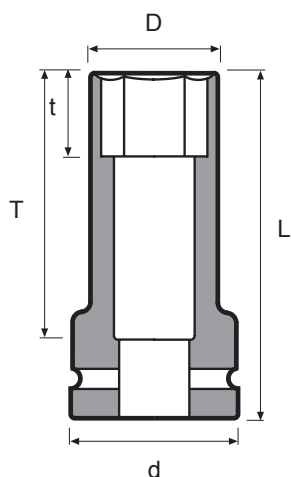

Part No	D mm	d mm	L mm	t mm	T mm	kg
1 3/16 5-30=1 3/16L	56	84	150	17	108	3,30
1 3/8 5-35=1 3/8L	61	84	150	20	108	3,79
1 1/2 5-38=1 1/2L	65	84	150	24	108	3,86
1 5/8 5-1 5/8L	70	84	150	27	106	3,70
1 11/16 5-43=1 11/16L	73	84	150	27	102	3,90
1 3/4 5-1 3/4L	75	84	150	29	102	3,70
1 13/16 5-46=1 13/16L	77	84	150	29	102	3,90
1 7/8 5-1 7/8L	78	84	150	30	102	3,80
1 15/16 5-1 15/16L	80	84	150	31	102	3,90
2 5-2L	82	84	150	32	102	3,90
2 1/16 5-2 1/16L	83	84	150	33	102	3,90
2 1/8 5-2 1/8L	84	84	150	35	102	4,00
2 3/16 5-2 3/16L	87	86	150	35	102	4,20
2 1/4 5-2 1/4L	90	86	150	36	102	4,40
2 5/16 5-2 5/16L	92	86	150	37	102	4,60
2 3/8 5-2 3/8L	94	86	150	39	102	4,80
2 7/16 5-2 7/16L	96	86	150	40	102	4,80
2 1/2 5-2 1/2L	97	86	150	41	102	4,90
2 9/16 5-65=2 9/16L	99	86	150	41	102	4,90
2 5/8 5-2 5/8L	102	86	170	43	126	6,10
2 11/16 5-2 11/16L	104	86	170	43	126	6,30
2 3/4 5-70=2 3/4L	105	86	170	45	126	6,40
2 13/16 5-2 13/16L	107	86	170	46	126	6,60
2 7/8 5-2 7/8L	110	86	170	46	126	6,80
2 15/16 5-2 15/16L	112	86	170	47	126	6,90
3 5-3L	116	86	170	48	126	7,60
3 1/16 5-3 1/16L	118	86	170	49	126	7,60
3 1/8 5-3 1/8L	119	86	170	51	126	7,60
3 3/16 5-3 3/16L	121	86	180	51	135	9,00
3 1/4 5-3 1/4L	123	86	180	52	135	9,20
3 3/8 5-3 3/8L	125	86	180	54	135	9,40
3 7/16 5-3 7/16L	129	86	180	55	127	9,31
3 1/2 5-3 1/2L	130	86	180	58	135	9,90
3 5/8 5-3 5/8L	136	102	180	58	135	10,30
3 3/4 5-95=3 3/4L	141	102	190	61	143	12,10
3 13/16 5-3 13/16L	142	102	190	61	136	12,42
3 7/8 5-3 7/8L	144	102	190	64	143	12,40
4 5-4L	148	102	190	64	143	12,80
4 1/16 5-4 1/16L	149	102	190	66	133	13,06
4 1/8 5-105=4 1/8L	151	102	190	66	143	13,20
4 3/16 5-4 3/16L	153	102	190	67	143	13,60
4 1/4 5-4 1/4L	155	102	200	70	150	14,70



	Part No	D mm	d mm	L mm	t mm	T mm	 kg
4 5/16	5-4 5/16L	157	102	200	70	141	14,78
4 3/8	5-4 3/8L	158	102	200	70	141	14,88
4 1/2	5-4 1/2L	163	102	200	72	150	15,10
4 5/8	5-4 5/8L	166	102	200	77	150	15,80
4 3/4	5-4 3/4L	170	102	200	77	138	16,14
4 7/8	5-4 7/8L	173	102	200	77	137	17,84
5	5-5L	178	102	210	77	146	18,93
5 1/8	5-5 1/8L	180	102	210	80	145	18,86
5 3/16	5-5 3/16L	182	102	210	80	145	19,09
5 1/4	5-5 1/4L	185	102	210	80	144	19,66
5 3/8	5-5 3/8L	188	102	210	80	143	20,34
5 1/2	5-5 1/2L	192	102	210	80	142	20,61
5 3/4	5-5 3/4L	199	102	210	85	140	21,42
5 7/8	5-5 7/8L	203	102	210	85	140	22,33
6	5-6L	206	102	210	85	139	22,99



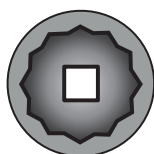
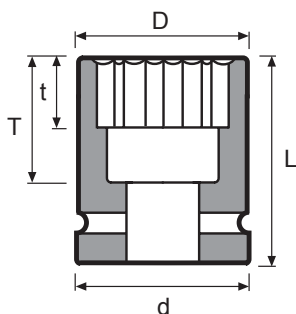

Artikel nr	D mm	d mm	L mm	t mm	T mm	kg
41 5-D6K41	70	84	84	23	36	2,25
43 5-D6K43=1 11/16	73	84	84	24	36	2,27
46 5-D6K46=1 13/16	76	84	87	25	40	2,32
50 5-D6K50	81	84	90	28	43	2,37
55 5-D6K55	86	86	90	30	47	2,70
60 5-D6K60	94	86	95	35	51	3,10
65 5-D6K65=2 9/16	99	86	100	35	56	3,50
70 5-D6K70=2 3/4	105	86	105	40	61	4,00
75 5-D6K75	112	86	110	42	66	4,60
80 5-D6K80	119	86	110	42	66	5,30
85 5-D6K85	125	86	120	50	75	6,40
90 5-D6K90	131	86	120	50	75	6,70
95 5-D6K95=3 3/4	141	102	130	55	83	8,70
100 5-D6K100	146	102	130	55	83	9,00
105 5-D6K105=4 1/8	151	102	130	55	83	9,40

**Can't find what
you're looking for?**

We can manufacture
special tools to meet your
individual requirements.

Contact us and we
will help you!

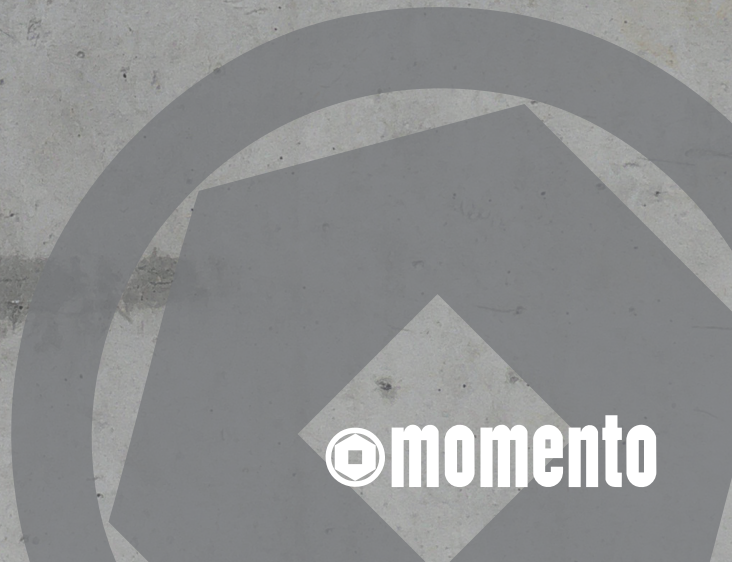

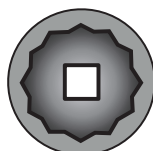
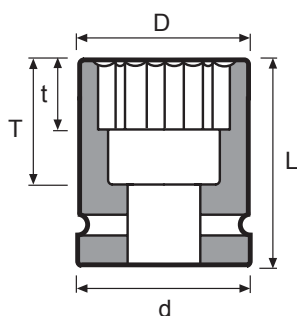

 momento



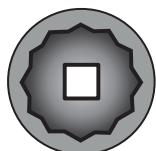
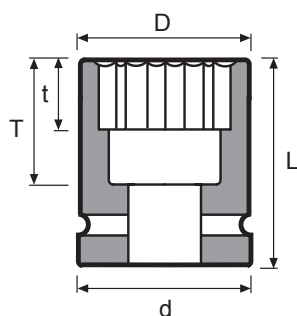

Part No	D mm	d mm	L mm	t mm	T mm	kg
1 5/8 5-D6K1 5/8	70	84	84	23	36	2,25
1 11/16 5-D6K43=1 11/16	73	84	84	24	36	2,27
1 3/4 5-D6K1 3/4	75	84	87	25	40	2,40
1 13/16 5-D6K46=1 13/16	76	84	87	25	40	2,32
1 7/8 5-D6K1 7/8	78	84	87	26	40	2,40
1 15/16 5-D6K1 15/16	80	84	90	28	43	2,40
2 5-D6K2	82	84	90	30	43	2,36
2 1/16 5-D6K2 1/16	83	84	90	30	43	2,50
2 1/8 5-D6K2 1/8	84	84	90	30	43	2,29
2 3/16 5-D6K2 3/16	87	86	95	30	51	2,90
2 1/4 5-D6K2 1/4	90	86	95	30	51	2,90
2 5/16 5-D6K2 5/16	92	86	95	30	51	3,00
2 3/8 5-D6K2 3/8	94	86	95	35	51	3,10
2 7/16 5-D6K2 7/16	96	86	100	35	56	3,30
2 1/2 5-D6K2 1/2	97	86	100	35	56	3,30
2 9/16 5-D6K65=2 9/16	99	86	100	35	56	3,50
2 5/8 5-D6K2 5/8	102	86	105	40	61	3,80
2 11/16 5-D6K2 11/16	104	86	105	40	61	3,90
2 3/4 5-D6K70=2 3/4	105	86	105	40	61	4,00
2 13/16 5-D6K2 13/16	107	86	110	42	66	4,20
2 7/8 5-D6K2 7/8	110	86	110	42	66	4,23
2 15/16 5-D6K2 15/16	112	86	110	42	66	4,60
3 5-D6K3	116	86	110	42	66	4,90
3 1/16 5-D6K3 1/16	118	86	110	42	66	5,10
3 1/8 5-D6K3 1/8	119	86	110	42	66	4,79
3 3/16 5-D6K3 3/16	121	86	120	50	75	5,70
3 1/4 5-D6K3 1/4	123	86	120	50	75	6,00
3 3/8 5-D6K3 3/8	125	86	120	50	75	6,20
3 1/2 5-D6K3 1/2	130	86	120	50	75	6,70
3 5/8 5-D6K3 5/8	136	102	120	50	75	7,00
3 3/4 5-D6K95=3 3/4	141	102	130	55	83	8,70
3 7/8 5-D6K3 7/8	144	102	130	55	83	8,15
3 15/16 5-D6K3 15/16	146	102	130	55	83	8,34
4 5-D6K4	148	102	130	55	83	9,10
4 1/8 5-D6K105=4 1/8	151	102	130	55	83	9,40
4 3/16 5-D6K4 3/16	153	102	130	55	83	11,10
4 1/4 5-D6K4 1/4	155	102	140	70	92	9,90
4 3/8 5-D6K4 3/8	158	102	140	70	92	10,30
4 1/2 5-D6K4 1/2	163	102	140	72	92	10,80
4 5/8 5-D6K4 5/8	166	102	140	77	90	10,90
4 3/4 5-D6K4 3/4	170	102	140	77	90	11,10
4 7/8 5-D6K4 7/8	173	102	140	77	90	11,50

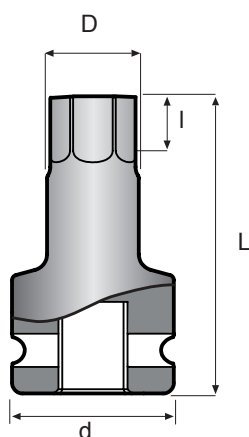

	Part No	D mm	d mm	L mm	t mm	T mm	 kg
5	5-D6K5	178	102	150	77	100	12,30
5 1/8	5-D6K5 1/8	180	102	150	80	100	12,90
5 3/16	5-D6K5 3/16	182	102	150	80	100	13,10
5 1/4	5-D6K5 1/4	185	102	150	80	100	13,40
5 3/8	5-D6K5 3/8	188	102	150	80	100	14,00
5 1/2	5-D6K5 1/2	192	102	150	80	100	15,00
5 9/16	5-D6K5 9/16	193	102	150	80	97	15,90
5 3/4	5-D6K5 3/4	199	102	150	85	97	17,40
5 7/8	5-D6K5 7/8	203	102	150	85	97	18,20
6	5-D6K6	206	102	150	85	97	18,60
6 1/8	5-D6K6 1/8	209	102	150	85	97	19,00



		Part No	D mm	d mm	L mm	I mm	 kg
5	22	5-U6K22	26	54	105	18	2,00
5	24	5-U6K24	29	54	105	20	2,05
5	27	5-U6K27	35	54	105	22	2,10
5	32	5-U6K32	38	54	105	26	2,22
5	36	5-U6K36	42	54	105	30	2,31
5	41	5-U6K41	48	62	105	36	2,45
5	46	5-U6K46	54	62	105	40	2,61
5	55	5-U6K55	64	62	105	46	2,95



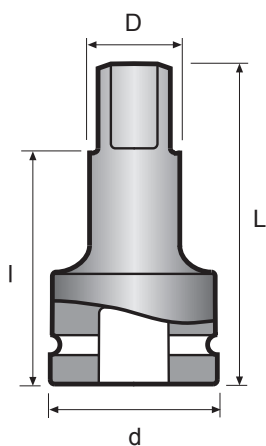

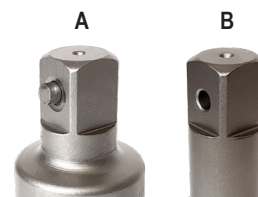

□	■	Part No	Model	D mm	d mm	L mm	I mm	kg
1 1/2	1 1/2	EB55-7	B	49,5	84	178	138,7	3,77
1 1/2	1 1/2	EB55-10	B	49,5	84	254	214,7	4,92
1 1/2	1 1/2	EB55-12	B	49,5	84	305	265,7	5,69
1 1/2	1 1/2	EB55-13	B	49,5	84	330	290,7	6,07
1 1/2	1 1/2	EB55-15	B	49,5	84	381	341,7	6,84

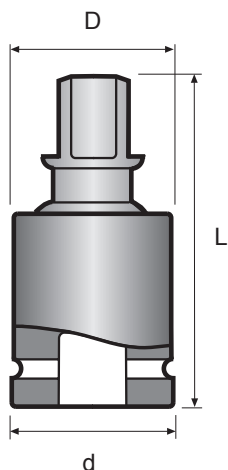



		Artikel nr	Model	D mm	d mm	L mm	kg
1 1/2	1 1/2	UK55	B	84	84	166	3,75

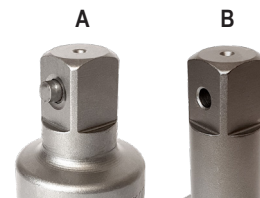

Can't find what you're looking for?
 We can manufacture special tools to meet your individual requirements. Contact us and we will help you!



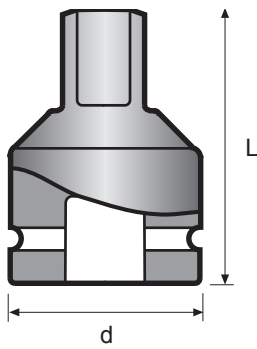

		Part No	Model	d mm	L mm	kg
1 1/2	1	PA59	B	84	88	1,75
1 1/2	1 1/4	PA53	B	84	88	1,76
1 1/2	2 1/2	PA56	B	102	120	5,00

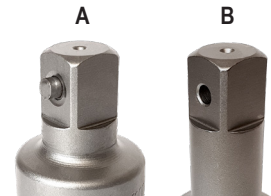

Var försiktig vid övergång till mindre fyrkant. Då mutterdragaren kan ge ett för högt vridmoment för den mindre tappen, lämnas ingen garanti.

Be careful when adapting to a smaller drive. As the power input may be too high for the smaller drive square, there is no guarantee when adapting down.

Seien Sie vorsichtig beim Übergang zu kleinen Antriebsvierkanten. Da das Drehmoment für den kleinen Vierkant zu hoch sein kann, kann keine Garantie übernommen werden.

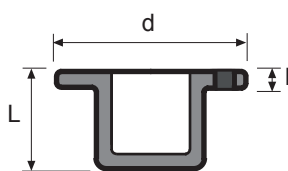
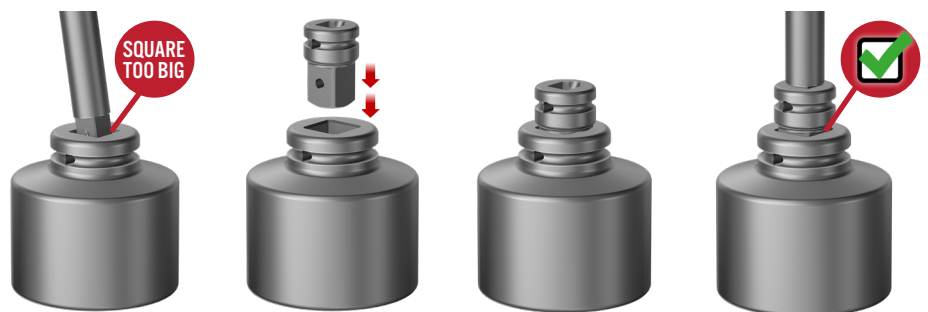

		Part No	d mm	L mm	l mm	kg
1 1/2	2 1/2	IPA56	137	65	10	2,35

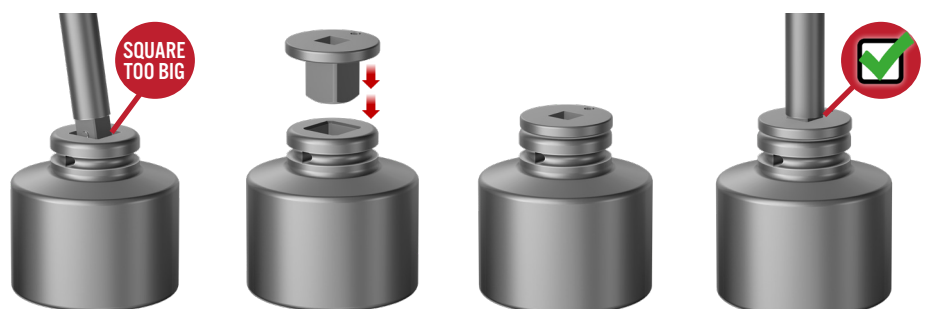

The total height

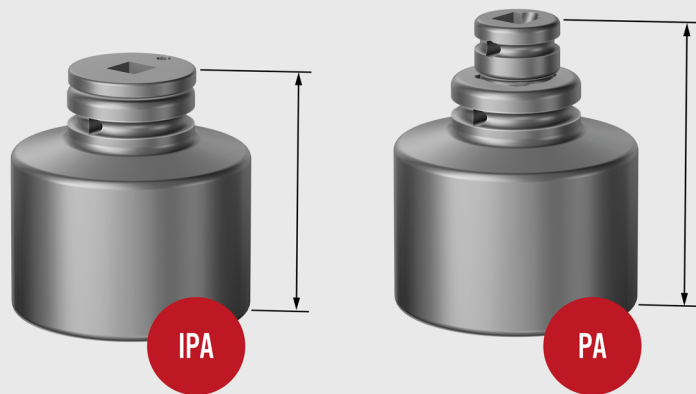

Secured with



i Info about different types of securing in the beginning of the catalogue.

The differens between IPA and PA adapters

There are some facts that you need to know to be able to pick the best adapter for your job.



- Säkras med Momento Locking, Ret ring eller Pinne och O-ring.
- Kräver större utrymme än IPA
- Secured with Momento Locking, Ret ring or Pin and O-ring.
- Requires more space than IPA
- Mit Momento Locking, Ret-Ring oder Sicherungsstifte und O-Ringe gesichert.
- Benötigt mehr Platz als IPA





- Används när utrymmet är begränsat
- Kan inte säkras med pinne och O-ring (Insatsövergången hålls kvar i hylsan med hjälp av en magnet)
- Used when space is limited
- Cannot be secured with pin and O-ring (The insert adapter sticks to the socket by means of a magnet)
- Wird verwendet, wenn der Platz begrenzt ist
- Kann nicht mit Sicherungsstifte und O-Ringe gesichert werden (Ein Magnet hält das Reduzierstück am Kraftsteckschlüssel)

2 1/2"

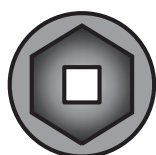
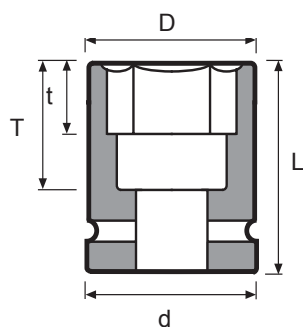



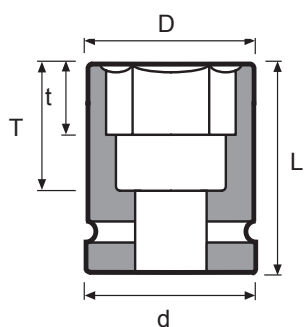
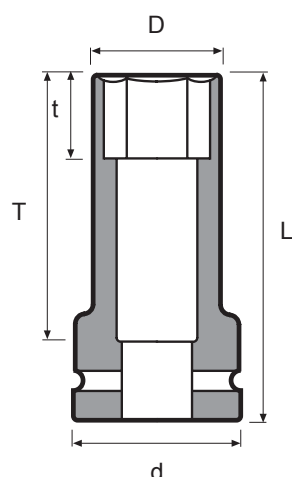

	Part No	D mm	d mm	L mm	t mm	T mm	 kg
50	6-50	86	127	130	28	70	6,75
55	6-55	93	127	130	30	70	6,89
60	6-60	99	127	130	35	70	6,98
65	6-65=2 9/16	105	127	130	35	70	7,09
70	6-70=2 3/4	112	127	130	40	70	7,27
75	6-75	118	127	130	45	70	7,38
80	6-80	124	127	130	45	70	7,52
85	6-85	130	127	130	50	70	7,74
90	6-90	137	127	140	50	80	8,89
95	6-95=3 3/4	143	127	140	55	80	9,26
100	6-100	149	127	140	55	80	9,69
105	6-105=4 1/8	155	127	150	60	90	10,85
110	6-110	162	127	150	65	90	11,46
115	6-115	168	127	150	65	90	11,89
120	6-120	181	160	150	70	90	16,75
125	6-125	187	160	150	75	90	17,50
130	6-130	195	160	170	75	110	21,50
135	6-135	202	160	170	80	110	22,10
140	6-140	208	160	170	80	110	23,00
145	6-145	214	160	170	80	110	23,50
150	6-150	219	160	170	85	110	24,00
155	6-155	224	160	180	90	120	26,40
160	6-160	229	160	180	90	120	26,90
165	6-165=6 1/2	235	160	180	95	120	27,65
170	6-170	240	160	180	95	120	28,11
175	6-175	247	160	180	95	120	29,34
180	6-180	253	160	225	110	145	41,40
185	6-185	258	160	225	110	145	42,30
190	6-190	264	160	225	120	145	43,60
200	6-200	276	160	225	120	145	46,60
210	6-210	287	160	225	120	145	49,20
215	6-215	293	160	225	120	145	50,80
225	6-225	304	160	225	120	145	53,30
230	6-230	310	160	225	120	145	54,70
235	6-235	316	160	225	120	145	56,40
250	6-250	333	160	225	120	145	61,20
255	6-255	339	160	225	120	145	63,20

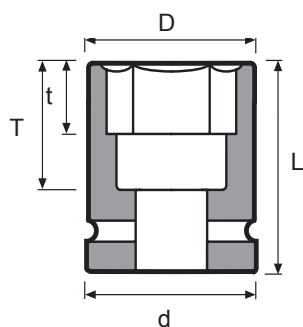

Part No	D mm	d mm	L mm	t mm	T mm	kg	
60	6-60L	99	127	180	35	120	8,93
65	6-65=2 9/16L	105	127	180	35	120	9,20
70	6-70=2 3/4L	112	127	180	40	120	9,57
75	6-75L	118	127	180	45	120	9,86
80	6-80L	124	127	180	45	120	10,28
85	6-85L	130	127	180	50	120	10,70
90	6-90L	137	127	200	50	120	12,86
95	6-95=3 3/4L	143	127	200	55	140	13,47
100	6-100L	149	127	200	55	140	14,17
105	6-105=4 1/8L	155	127	220	60	160	16,44
110	6-110L	162	127	220	65	160	17,53
115	6-115L	168	127	220	65	160	18,36
120	6-120L	181	160	220	70	160	24,95
125	6-125L	187	160	220	75	160	25,90
130	6-130L	195	160	250	75	190	31,44
135	6-135L	202	160	250	80	190	33,17
140	6-140L	208	160	250	80	190	34,50
145	6-145L	214	160	250	80	190	35,70
150	6-150L	219	160	250	85	190	36,50
155	6-155L	224	160	250	90	190	37,50
160	6-160L	229	160	250	90	190	38,50
165	6-165L	235	160	250	95	190	40,00
170	6-170L	240	160	250	95	190	40,60

2	6-2	88	127	130	30	70	6,80
2 3/16	6-2 3/16	94	127	130	30	70	6,85
2 5/16	6-2 5/16	96	127	130	30	70	6,90
2 3/8	6-2 3/8	99	127	130	35	70	6,98
2 7/16	6-2 7/16	102	127	130	35	70	7,00
2 1/2	6-2 1/2	103	127	130	35	70	7,00
2 9/16	6-65=2 9/16	105	127	130	35	70	7,09
2 5/8	6-2 5/8	108	127	130	40	70	7,10
2 11/16	6-2 11/16	109	127	130	40	70	7,15
2 3/4	6-70=2 3/4	112	127	130	40	70	7,27
2 13/16	6-2 13/16	113	127	130	45	70	7,30
2 7/8	6-2 7/8	115	127	130	45	70	7,30
2 15/16	6-2 15/16	118	127	130	45	70	7,38
3	6-3	119	127	130	45	70	7,38
3 1/16	6-3 1/16	120	127	130	45	70	7,40



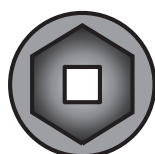
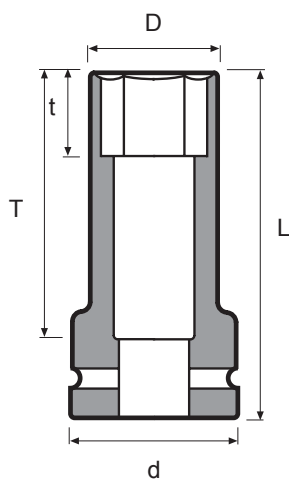
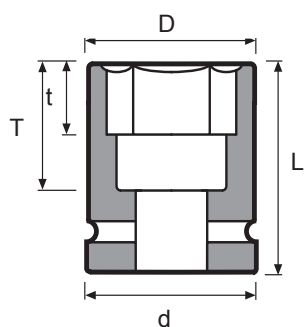

		Part No	D mm	d mm	L mm	t mm	T mm	 kg
	3 1/8	6-3 1/8	124	127	130	45	70	7,52
	3 1/4	6-3 1/4	127	127	130	50	70	7,63
	3 5/16	6-3 5/16	129	127	130	50	70	7,70
	3 3/8	6-3 3/8	130	127	130	50	70	7,74
	3 1/2	6-3 1/2	135	127	140	50	80	8,80
	3 9/16	6-3 9/16	137	127	140	50	80	8,89
	3 5/8	6-3 5/8	139	127	140	55	80	9,00
	3 3/4	6-95=3 3/4	143	127	140	55	80	9,26
	3 7/8	6-3 7/8	147	127	140	55	80	9,50
	4	6-4	151	127	140	60	80	9,69
	4 1/8	6-105=4 1/8	155	127	150	60	90	10,85
	4 3/16	6-4 3/16	157	127	150	65	90	11,10
	4 1/4	6-4 1/4	159	127	150	65	90	11,30
	4 3/8	6-4 3/8	163	127	150	65	90	11,60
	4 1/2	6-4 1/2	167	127	150	65	90	11,80
	4 9/16	6-4 9/16	176	160	150	70	90	11,90
	4 5/8	6-4 5/8	178	160	150	70	90	15,20
	4 3/4	6-4 3/4	181	160	150	70	90	16,90
	4 7/8	6-4 7/8	186	160	150	75	90	17,30
	5	6-5	190	160	170	75	110	21,00
	5 1/8	6-5 1/8	195	160	170	75	110	22,00
	5 3/16	6-5 3/16	198	160	170	80	110	22,00
	5 1/4	6-5 1/4	200	160	170	80	110	22,50
	5 3/8	6-5 3/8	204	160	170	80	110	23,00
	5 1/2	6-5 1/2	208	160	170	80	110	23,00
	5 9/16	6-5 9/16	210	160	170	80	110	24,00
	5 3/4	6-5 3/4	216	160	170	85	110	25,00
	5 7/8	6-5 7/8	219	160	170	85	110	26,00
	6	6-6	221	160	180	85	120	30,00
	6 1/8	6-6 1/8	224	160	180	90	120	30,00
	6 1/4	6-6 1/4	228	160	180	90	120	30,50
	6 3/8	6-6 3/8	232	160	180	90	120	31,00
	6 1/2	6-165=6 1/2	235	160	180	95	120	32,00
	6 3/4	6-6 3/4	243	160	180	95	120	33,00
	6 7/8	6-6 7/8	247	160	180	95	120	33,50
	7	6-7	250	160	180	95	120	35,50
	7 1/8	6-7 1/8	253	160	225	110	145	41,40
	7 1/4	6-7 1/4	258	160	225	110	145	42,00
	7 5/16	6-7 5/16	260	160	225	120	145	42,40
	7 1/2	6-7 1/2	264	160	225	120	145	43,60
	7 5/8	6-7 5/8	269	160	225	120	145	44,00
	7 13/16	6-7 13/16	273	160	225	120	145	46,00



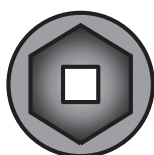
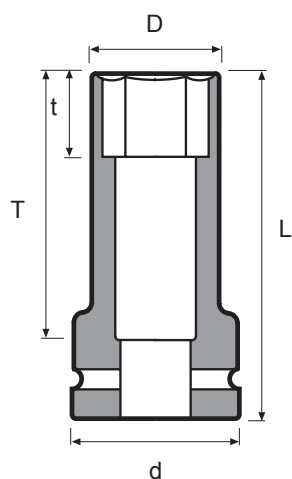



Part No	D mm	d mm	L mm	t mm	T mm	kg
8 3/8	291	160	225	120	145	50,00
8 7/16	304	160	225	120	145	53,30
9 1/8	312	160	225	120	145	54,70
9 7/16	322	160	225	120	145	59,00
10	338	160	225	120	145	63,50
2 3/8	99	127	180	35	120	8,90
2 7/16	102	127	180	35	120	9,00
2 1/2	103	127	180	35	120	9,10
2 9/16	105	127	180	35	120	9,20
2 5/8	108	127	180	40	120	9,30
2 11/16	109	127	180	40	120	9,40
2 3/4	112	127	180	40	120	9,57
2 13/16	113	127	180	45	120	9,70
2 7/8	115	127	180	45	120	9,80
2 15/16	118	127	180	45	120	9,86
3	119	127	180	45	120	9,95
3 1/16	120	127	180	45	120	10,00
3 1/8	124	127	180	45	120	10,20
3 1/4	127	127	180	50	120	10,50
3 3/8	130	127	180	50	140	10,75
3 1/2	135	127	200	50	140	12,80
3 5/8	139	127	200	55	140	13,17
3 3/4	143	127	200	55	140	13,47
3 7/8	147	127	200	55	140	13,80
4	151	127	200	60	140	14,30
4 1/8	155	127	220	60	160	16,44
4 3/16	157	127	220	65	160	16,70
4 1/4	159	127	220	65	160	17,00
4 3/8	163	127	220	65	160	17,80
4 1/2	167	127	220	65	160	18,20
4 5/8	178	160	220	70	160	24,50
4 3/4	181	160	220	70	160	24,90
4 7/8	186	160	220	75	160	25,77
5	190	160	250	75	190	30,19
5 1/8	195	160	250	75	190	31,44
5 3/16	198	160	250	80	190	32,25
5 1/4	200	160	250	80	190	32,88
5 3/8	204	160	250	80	190	33,47
5 1/2	208	160	250	80	190	34,40
5 3/4	216	160	250	85	190	36,00
5 7/8	219	160	250	85	190	36,30

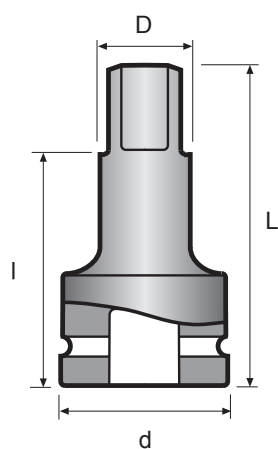

	Part No	D mm	d mm	L mm	t mm	T mm	 kg
6	6-6L	221	160	250	85	190	36,68
6 1/8	6-6 1/8L	224	160	250	90	190	36,90
6 1/4	6-6 1/4L	228	160	250	90	190	38,30
6 3/8	6-6 3/8L	232	160	250	90	190	38,74
6 1/2	6-6 1/2L	235	160	250	95	190	38,74
6 3/4	6-6 3/4L	243	160	250	95	190	40,80
6 7/8	6-6 7/8L	247	160	250	95	190	42,50
7	6-7L	250	160	250	95	190	43,00

2 1/2"



		Part No	Model	D mm	d mm	L mm	I mm	 kg
2 1/2	2 1/2	EB66-7	B	83,5	127	178	122,4	9,44
2 1/2	2 1/2	EB66-10	B	83,5	127	254	198,4	12,70
2 1/2	2 1/2	EB66-13	B	83,5	127	330	274,4	16,00
2 1/2	2 1/2	EB66-15	B	83,5	127	384	328,4	18,30

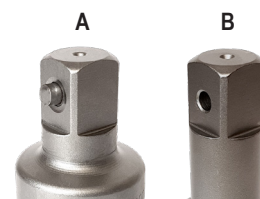

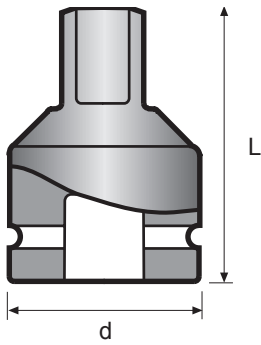

		Part No	Model	d mm	L mm	kg
2 1/2	1 1/2	PA65	B	127	125	5,57

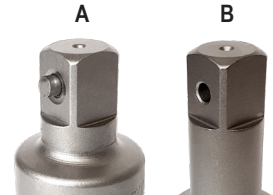

- Var försiktig vid övergång till mindre fyrkant. Då mutterdragaren kan ge ett för högt vridmoment för den mindre tappen, lämnas ingen garanti.
- Be careful when adapting to a smaller drive. As the power input may be too high for the smaller drive square, there is no guarantee when adapting down.
- Seien Sie vorsichtig beim Übergang zu kleinen Antriebsvierkanten. Da das Drehmoment für den kleinen Vierkant zu hoch sein kann, kann keine Garantie übernommen werden.

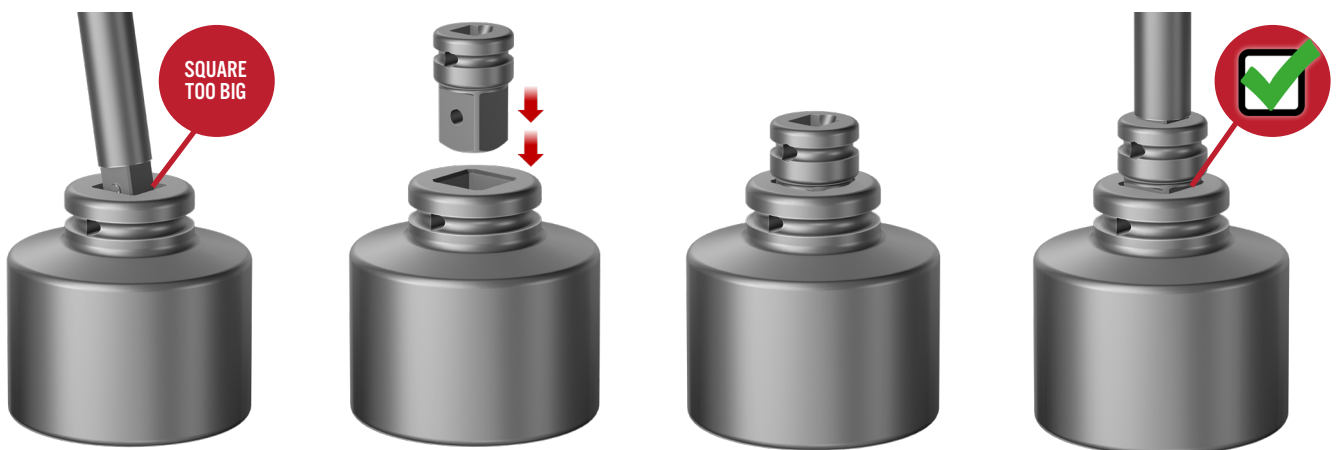



3 1/2"

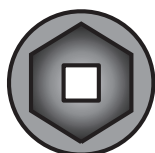
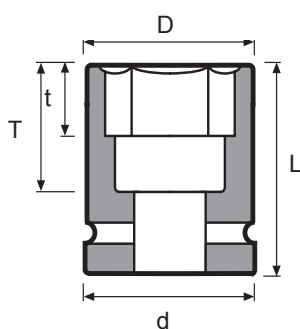

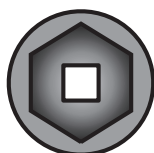
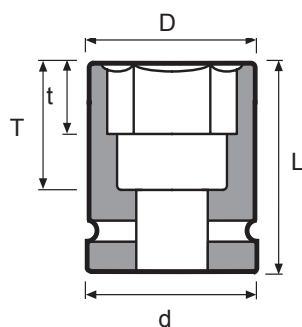

Part No	D mm	d mm	L mm	t mm	T mm	kg	
105	12-105=4 1/8	180	195	205	60	118	30,00
110	12-110	186	195	205	65	118	31,00
115	12-115	192	195	205	65	118	32,00
120	12-120	199	195	205	75	118	33,00
125	12-125	203	195	205	75	118	34,00
130	12-130	209	195	205	75	118	35,00
135	12-135	215	195	205	80	118	36,00
140	12-140	221	195	205	80	118	37,00
145	12-145	227	195	205	80	118	38,00
150	12-150	233	195	205	85	118	39,00
155	12-155	239	195	205	85	118	40,00
160	12-160	245	195	230	90	142	43,00
165	12-165=6 1/2	251	195	230	95	142	48,00
170	12-170	257	195	230	95	142	49,00
175	12-175	263	195	230	100	142	50,00
180	12-180	270	230	250	120	162	69,00
185	12-185	275	230	250	120	162	62,50
190	12-190	281	230	250	120	162	71,00
200	12-200	292	230	250	120	162	73,00
210	12-210	304	230	250	120	162	77,00
215	12-215	310	230	250	120	162	80,00
235	12-235	334	230	275	140	158	94,00
255	12-255	358	230	275	140	158	102,00
4	12-4	176	195	205	60	118	28,00
4 1/8	12-105=4 1/8	180	195	205	60	118	30,00
4 3/16	12-4 3/16	182	195	205	60	118	30,00
4 1/4	12-4 1/4	184	195	205	60	118	31,00
4 3/8	12-4 3/8	187	195	205	60	118	31,00
4 1/2	12-4 1/2	192	195	205	60	118	32,00
4 5/8	12-4 5/8	196	195	205	75	118	33,00
4 3/4	12-4 3/4	199	195	205	75	118	32,00
4 7/8	12-4 7/8	203	195	205	75	118	33,00
5	12-5	207	195	205	75	118	34,00
5 1/8	12-5 1/8	209	195	205	75	118	34,00
5 3/16	12-5 3/16	212	195	205	80	118	35,00
5 1/4	12-5 1/4	214	195	205	80	118	36,00
5 3/8	12-5 3/8	217	195	205	80	118	36,00
5 1/2	12-5 1/2	221	195	205	80	118	37,00



	Part No	D mm	d mm	L mm	t mm	T mm		kg
5 9/16	12-5 9/16	223	195	205	80	118		38,00
5 3/4	12-5 3/4	228	195	205	85	118		38,00
5 7/8	12-5 7/8	233	195	205	85	118		39,00
6	12-6	235	195	205	85	118		39,00
6 1/8	12-6 1/8	239	195	205	85	118		40,00
6 1/4	12-6 1/4	244	195	230	90	142		43,00
6 3/8	12-6 3/8	247	195	230	95	142		45,00
6 1/2	12-165=6 1/2	251	195	230	95	142		48,00
6 3/4	12-6 3/4	259	195	230	95	142		49,00
6 7/8	12-6 7/8	263	195	230	100	142		50,00
7	12-7	268	230	250	120	162		67,00
7 1/8	12-7 1/8	270	230	250	120	162		69,00
7 1/4	12-7 1/4	275	230	250	120	162		70,00
7 5/16	12-7 5/16	277	230	250	120	162		70,00
7 1/2	12-7 1/2	281	230	250	120	162		71,00
7 5/8	12-7 5/8	285	230	250	120	162		72,00
7 13/16	12-7 13/16	290	230	250	120	162		73,00
8 3/8	12-8 3/8	308	230	250	120	162		78,00
8 7/8	12-8 7/8	322	230	250	120	162		84,00
9 1/8	12-9 1/8	329	230	250	120	162		86,00
9 7/16	12-9 7/16	339	230	275	140	158		90,00
10	12-10	358	230	275	140	158		102,00

Need another size?

We can manufacture special tools to meet your individual requirements. Contact us and we will help you!



Bits och tillbehör

Vi har ett utökat program med bits och tillbehör. Vårt bitprogram är, som våra andra produkter, av hög kvalitet som uppfyller krav enligt gällande standarder.



Bits and accessories

We have an expanded program of bits and accessories. Our bit program, like our other products, is of a high quality that meets the requirements of current standards.



Bits und Zubehör

Wir haben ein breites Sortiment an Bits und Zubehör. Wir sparen auch nicht an Qualität mit unseren Bits. Hierbei garantieren wir eine stets gleichbleibende Qualität, die den DIN- und Marktanforderungen jederzeit standhalten können.



Don't miss out!

Scan the QR code to access the catalog with bits and accessories.



NUTSETTERS



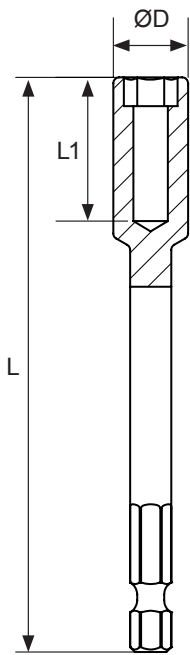

Part No	L mm	L1 mm	D mm	With Plastic cover	D mm
7 PNS1-7L75	75	40	11	PNS1-7L75RP	15
7 PNS1-7L100	100	40	11	PNS1-7L100RP	15
7 PNS1-7L150	150	40	11	PNS1-7L150RP	15
7 PNS1-7L200	200	40	11	PNS1-7L200RP	15
8 PNS1-8L75	75	40	12	PNS1-8L75RP	16,6
8 PNS1-8L100	100	40	12	PNS1-8L100RP	16,6
8 PNS1-8L150	150	40	12	PNS1-8L150RP	16,6
8 PNS1-8L200	200	40	12	PNS1-8L200RP	16,6
10 PNS1-10L75	75	40	14,5	PNS1-10L75RP	18,5
10 PNS1-10L100	100	40	14,5	PNS1-10L100RP	18,5
10 PNS1-10L150	150	40	14,5	PNS1-10L150RP	18,5
10 PNS1-10L200	200	40	14,5	PNS1-10L200RP	18,5
12 PNS1-12L75	75	40	17	PNS1-12L75RP	21,25
12 PNS1-12L100	100	40	17	PNS1-12L100RP	21,25
12 PNS1-12L150	150	40	17	PNS1-12L150RP	21,25
12 PNS1-12L200	200	40	17	PNS1-12L200RP	21,25
13 PNS1-13L75	75	40	18	PNS1-13L75RP	22
13 PNS1-13L100	100	40	18	PNS1-13L100RP	22
13 PNS1-13L150	150	40	18	PNS1-13L150RP	22
13 PNS1-13L200	200	40	18	PNS1-13L200RP	22
14 PNS1-14L75	75	40	19	PNS1-14L75RP	23
14 PNS1-14L100	100	40	19	PNS1-14L100RP	23
14 PNS1-14L150	150	40	19	PNS1-14L150RP	23
14 PNS1-14L200	200	40	19	PNS1-14L200RP	23



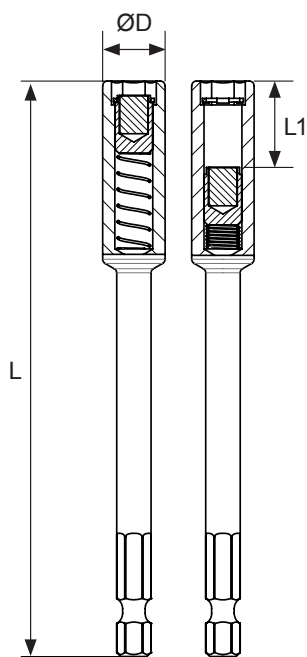



Part No	L mm	L1 mm	D mm	With Plastic cover	D mm
7 PNS1-7RML75	75	20	11	PNS1-7RML75RP	15
7 PNS1-7RML100	100	20	11	PNS1-7RML100RP	15
7 PNS1-7RML150	150	20	11	PNS1-7RML150RP	15
7 PNS1-7RML200	200	20	11	PNS1-7RML200RP	15
8 PNS1-8RML75	75	20	12	PNS1-8RML75RP	16,6
8 PNS1-8RML100	100	20	12	PNS1-8RML100RP	16,6
8 PNS1-8RML150	150	20	12	PNS1-8RML150RP	16,6
8 PNS1-8RML200	200	20	12	PNS1-8RML200RP	16,6
10 PNS1-10RML75	75	20	14,5	PNS1-10RML75RP	18,5
10 PNS1-10RML100	100	20	14,5	PNS1-10RML100RP	18,5
10 PNS1-10RML150	150	20	14,5	PNS1-10RML150RP	18,5
10 PNS1-10RML200	200	20	14,5	PNS1-10RML200RP	18,5
12 PNS1-12RML75	75	20	17	PNS1-12RML75RP	21,25
12 PNS1-12RML100	100	20	17	PNS1-12RML100RP	21,25
12 PNS1-12RML150	150	20	17	PNS1-12RML150RP	21,25
12 PNS1-12RML200	200	20	17	PNS1-12RML200RP	21,25
13 PNS1-13RML75	75	20	18	PNS1-13RML75RP	22
13 PNS1-13RML100	100	20	18	PNS1-13RML100RP	22
13 PNS1-13RML150	150	20	18	PNS1-13RML150RP	22
13 PNS1-13RML200	200	20	18	PNS1-13RML200	22
14 PNS1-14RML75	75	20	19	PNS1-14RML75RP	23
14 PNS1-14RML100	100	20	19	PNS1-14RML100RP	23
14 PNS1-14RML150	150	20	19	PNS1-14RML150RP	23
14 PNS1-14RML200	200	20	19	PNS1-14RML200RP	23

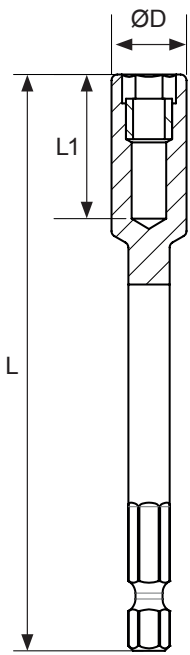

If you need a plastic cover for your nutsetter, just add "RP" to the part. no.



	Part No	L mm	L1 mm	D mm	With Plastic cover	D mm
7	PNS1-7MRL75	75	40	11	PNS1-7MRL75RP	15
7	PNS1-7MRL100	100	40	11	PNS1-7MRL100RP	15
7	PNS1-7MRL150	150	40	11	PNS1-7MRL150RP	15
7	PNS1-7MRL200	200	40	11	PNS1-7MRL200RP	15
8	PNS1-8MRL75	75	40	12	PNS1-8MRL75RP	16,6
8	PNS1-8MRL100	100	40	12	PNS1-8MRL100RP	16,6
8	PNS1-8MRL150	150	40	12	PNS1-8MRL150RP	16,6
8	PNS1-8MRL200	200	40	12	PNS1-8MRL200RP	16,6
10	PNS1-10MRL75	75	40	14,5	PNS1-10MRL75RP	18,5
10	PNS1-10MRL100	100	40	14,5	PNS1-10MRL100RP	18,5
10	PNS1-10MRL150	150	40	14,5	PNS1-10MRL150RP	18,5
10	PNS1-10MRL200	200	40	14,5	PNS1-10MRL200RP	18,5
12	PNS1-12MRL75	75	40	17	PNS1-12MRL75RP	21,25
12	PNS1-12MRL100	100	40	17	PNS1-12MRL100RP	21,25
12	PNS1-12MRL150	150	40	17	PNS1-12MRL150RP	21,25
12	PNS1-12MRL200	200	40	17	PNS1-12MRL200RP	21,25
13	PNS1-13MRL75	75	40	18	PNS1-13MRL75RP	22
13	PNS1-13MRL100	100	40	18	PNS1-13MRL100RP	22
13	PNS1-13MRL150	150	40	18	PNS1-13MRL150RP	22
13	PNS1-13MRL200	200	40	18	PNS1-13MRL200RP	22
14	PNS1-14MRL75	75	40	19	PNS1-14MRL75RP	23
14	PNS1-14MRL100	100	40	19	PNS1-14MRL100RP	23
14	PNS1-14MRL150	150	40	19	PNS1-14MRL150RP	23
14	PNS1-14MRL200	200	40	19	PNS1-14MRL200RP	23

Can't find what
you're looking for?

We can manufacture
special tools to meet your
individual requirements.
Contact us and we
will help you!



INSERT BITS





Hållare

Holders

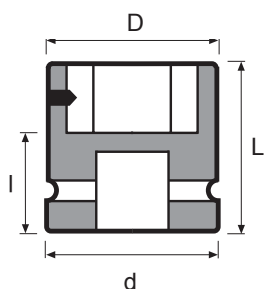
Halter





		Part No	D mm	d mm	L mm	l mm	 kg
3/8	1/4	H1-1/4	15	19	34	20,5	0,05
3/8	7/16	H1-7/16	22,6	22,6	34	22	0,08
1/2	7/16	H4-7/16	22,6	25	38	26	0,10
1/2	7/8	H4-7/8	38	30	50	30	0,29
5/8	7/8	H8-7/8	38	35	55	35	0,33
3/4	7/8	H2-7/8	44	44	55	35	0,46
1	7/8	H9-7/8	48	54	60	40	0,70
1	1 1/4	H9-1 1/4	63	54	75	45	1,20
1 1/2	1 1/4	H5-1 1/4	68	84	88	58	2,33
1 1/2	1 3/4	H5-1 3/4	84	84	110	70	3,24

Insatsmejslar

Insert bits

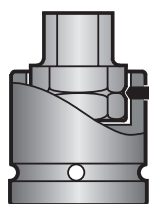
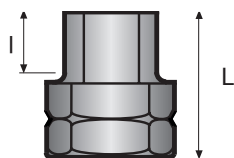
Einsatzklingen

7/16" 

	Part No	L mm	l mm	 kg
5	7/16-5	28	6	0,02
6	7/16-6	28	7	0,02
8	7/16-8	28	8	0,02
10	7/16-10	28	10	0,02
12	7/16-12	28	13	0,03
14	7/16-14	28	13	0,03
17	7/16-17	28	13	0,04



Insatsmejslarna låses med en spetsig skruv mot ett v-format spår i insatsmejselns hörn. Vid behov kan skruven säkras ytterligare med gänglåsningsmedel.



The insert bit is secured by means of a pointed screw against a v-shaped groove in the corners of the insert bit. If necessary the screw can be further secured by a threadlocking material.



Die Einsatzklinge wird durch eine Spitzschraube in einer V-förmigen Nut im Eckbereich der Klinge gesichert. Wenn erforderlich, kann die Schraube mit einem Klebstoff weiter gesichert werden. Marktanforderungen jederzeit standhalten können.

7/16" 

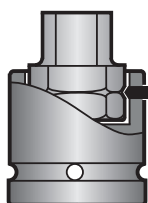
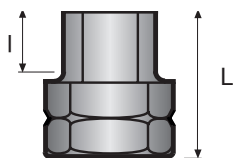

Part No

L
mm

l
mm

kg

5	7/16-5L	100	6	0,04
6	7/16-6L	100	6	0,05
8	7/16-8L	100	9	0,06
10	7/16-10L	100	10	0,06
12	7/16-12L	100	13	0,10
14	7/16-14L	100	14	0,10
17	7/16-17L	100	14	0,11

1/4	7/16-1/4	28	7	0,02
5/16	7/16-5/16	28	8	0,02
3/8	7/16-3/8	28	10	0,02
7/16	7/16-7/16	28	10	0,02
1/2	7/16-1/2	28	13	0,03
9/16	7/16-9/16	28	13	0,03



Insatsmejslarna låses med en spetsig skruv mot ett v-format spår i insatsmejselns hörn. Vid behov kan skruven säkras ytterligare med gänglåsningmedel.





The insert bit is secured by means of a pointed screw against a v-shaped groove in the corners of the insert bit. If necessary the screw can be further secured by a threadlocking material.

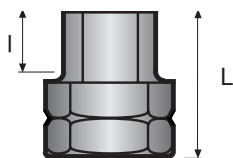

Die Einsatzklinge wird durch eine Spitzschraube in einer V-förmigen Nut im Eckbereich der Klinge gesichert. Wenn erforderlich, kann die Schraube mit einem Klebstoff weiter gesichert werden. Marktanforderungen jederzeit standhalten können.

7/8" 



	Part No	L mm	l mm	 kg
10	7/8-10	44	7	0,10
12	7/8-12	44	10	0,11
14	7/8-14	44	12	0,11
16	7/8-16	44	13	0,12
17	7/8-17	44	13	0,12
18	7/8-18	44	16	0,13
19	7/8-19	44	16	0,13
20	7/8-20	44	16	0,14
22	7/8-22	44	16	0,15
24	7/8-24	44	19	0,16
10	7/8-10L	100	10	0,15
12	7/8-12L	100	13	0,18
14	7/8-14L	100	14	0,21
16	7/8-16L	100	16	0,24
17	7/8-17L	100	16	0,26
18	7/8-18L	100	18	0,30
19	7/8-19L	100	18	0,30
20	7/8-20L	100	18	0,34
22	7/8-22L	100	18	0,38
24	7/8-24L	100	22	0,43
3/8	7/8-3/8	44	7	0,10
1/2	7/8-1/2	44	10	0,11
9/16	7/8-9/16	44	13	0,11
5/8	7/8-5/8	44	13	0,12
11/16	7/8-11/16	44	13	0,12
3/4	7/8-3/4	44	16	0,13
13/16	7/8-13/16	44	16	0,14
7/8	7/8-7/8	44	16	0,15
1	7/8-1	44	19	0,17

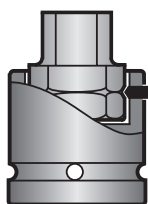

Insatsmejslarna låses med en spetsig skruv mot ett v-format spår i insatsmejselns hörn. Vid behov kan skruven säkras ytterligare med gänglåsningsmedel.



The insert bit is secured by means of a pointed screw against a v-shaped groove in the corners of the insert bit. If necessary the screw can be further secured by a threadlocking material.



Die Einsatzklinge wird durch eine Spitzschraube in einer V-förmigen Nut im Eckbereich der Klinge gesichert. Wenn erforderlich, kann die Schraube mit einem Klebstoff weiter gesichert werden. Marktanforderungen jederzeit standhalten können.

1 1/4" 

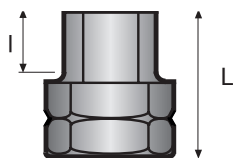

Part No

L
mm

l
mm

kg

19	1 1/4-19	60	18	0,30
22	1 1/4-22	60	20	0,32
24	1 1/4-24	60	22	0,34
27	1 1/4-27	60	22	0,36
30	1 1/4-30	60	26	0,38
32	1 1/4-32	60	28	0,41
33	1 1/4-33	60	28	0,42
36	1 1/4-36	65	33	0,50
1	1 1/4-1	60	22	0,34
1 1/16	1 1/4-1 1/16	60	22	0,36
1 1/8	1 1/4-1 1/8	60	26	0,37
1 3/16	1 1/4-1 3/16	60	26	0,39
1 1/4	1 1/4-1 1/4	60	28	0,41
1 5/16	1 1/4-1 5/16	60	28	0,43

1 3/4" 

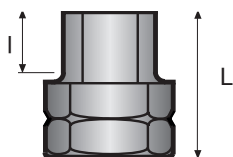

Part No

L
mm

l
mm

kg

36	1 3/4-36	80	35	0,90
41	1 3/4-41	80	35	0,64
46	1 3/4-46	85	40	1,17
50	1 3/4-50	90	45	1,36
1 3/8	1 3/4-1 3/8	80	30	0,47
1 1/2	1 3/4-1 1/2	80	35	0,94
1 5/8	1 3/4-1 5/8	80	35	0,98
1 3/4	1 3/4-1 3/4	80	35	1,06
1 7/8	1 3/4-1 7/8	85	40	0,90
2	1 3/4-2	90	45	1,40

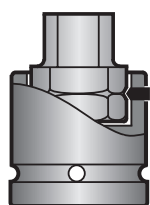

Insatsmejslarna låses med en spetsig skruv mot ett v-format spår i insatsmejslens hörn. Vid behov kan skruven säkras ytterligare med gänglåsningmedel.



The insert bit is secured by means of a pointed screw against a v-shaped groove in the corners of the insert bit. If necessary the screw can be further secured by a threadlocking material.



Die Einsatzklinge wird durch eine Spitzschraube in einer V-förmigen Nut im Eckbereich der Klinge gesichert. Wenn erforderlich, kann die Schraube mit einem Klebstoff weiter gesichert werden. Marktanforderungen jederzeit standhalten können.

SOCKETS FOR AXIAL NUTS



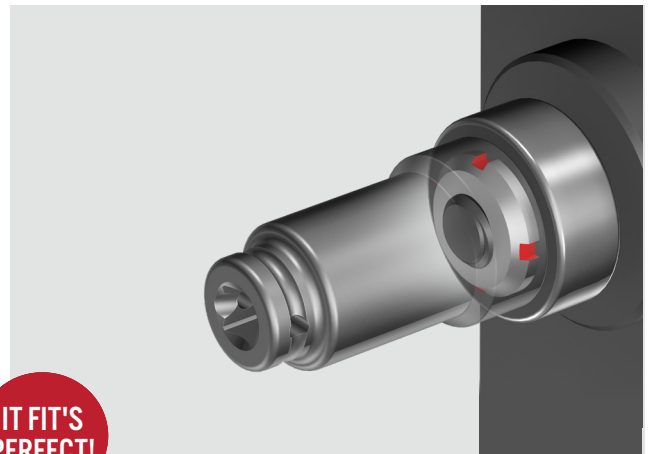
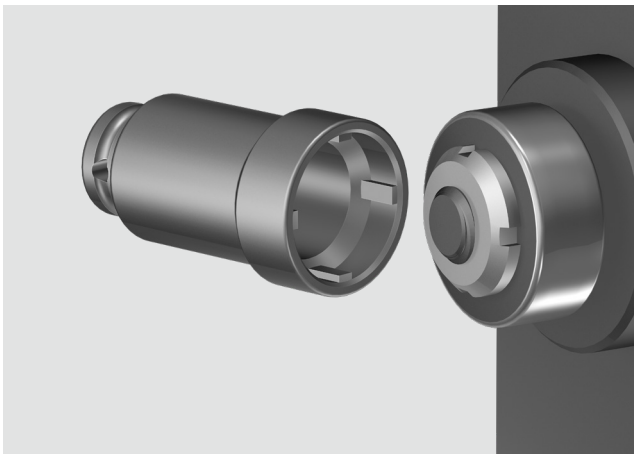

IT FIT'S
PERFECT!



 Dessa hylsor för kullagermuttrar ersätter haknycklar och gör det möjligt att använda mutterdragare eller momentnyckel.

 These sockets for axial nuts replace hook spanners making the use of power tools or torque wrenches possible.

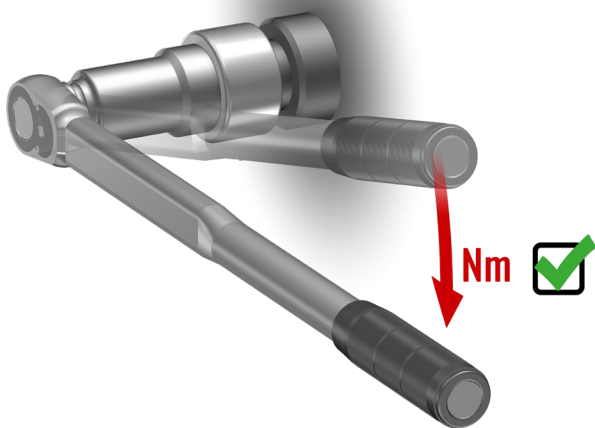
 Steckschlüssel für Wellenmuttern ersetzen Hakenschlüssel und ermöglichen den Einsatz von Schraubern oder Drehmomentschlüsseln.



YOU WILL HAVE FULL CONTROL

-  Drar åt kullagermuttrarna med precision till föreskrivet moment.
-  Tighten the axial nuts accurately according to factory specs.
-  Sie können Wellenmuttern exakt und gemäß den Werksangaben anziehen.



3/8" □



Part No

D
mmd
mmid
mmL
mmt
mmT
mm

kg

Tänder
Teeth
Zähne

KM0	1-KM0	22	22	18,3	57	5	44	0,11	4
KM1	1-KM1	28	22	22,4	57	5	44	0,11	4

1/2" □



Part No

D
mmd
mmid
mmL
mmt
mmT
mm

kg

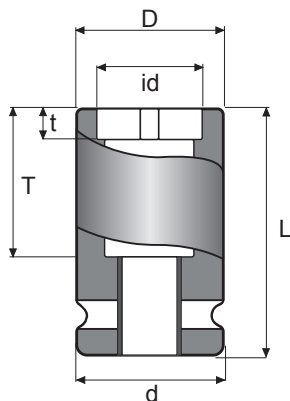
Tänder
Teeth
Zähne

KM2	4-KM2	33	30	25,4	82	6	65	0,27	4
KM3	4-KM3	36	30	28,4	82	6	65	0,24	4
KM4	4-KM4	38	30	32,5	82	9	56	0,28	4
KM5	4-KM5	46	30	38,5	82	9	56	0,38	4
KM6	4-KM6	53	30	45,5	82	9	56	0,42	4
KM7	4-KM7	60	30	52,5	82	9	56	0,47	4
KM8	4-KM8	68	30	58,5	82	9	56	0,61	4

3/4" □



Part No

D
mmd
mmid
mmL
mmt
mmT
mm

kg

Tänder
Teeth
Zähne

KM9	2-KM9	74,0	44	65,8	90	14,0	65	0,80	4
KM10	2-KM10	79,0	44	70,8	90	14,0	65	0,90	4
KM11	2-KM11	84,0	44	75,8	90	14,0	65	0,90	4
KM12	2-KM12	89,0	44	80,8	90	14,0	65	1,04	4
KM13	2-KM13	94	44	85,8	90	14,0	65	1,12	4

1" □



Part No

D
mmd
mmid
mmL
mmt
mmT
mm

kg

Tänder
Teeth
Zähne

KM14	9-KM14	103	62	92,6	110	12	75	1,90	4
KM15	9-KM15	109	62	98,6	110	13	75	2,05	4
KM16	9-KM16	116	62	105,8	110	15	75	2,20	4
KM17	9-KM17	121	62	110,8	110	16	75	2,25	4
KM18	9-KM18	131	62	120,8	110	16	75	2,50	4
KM19	9-KM19	137	62	125,8	110	17	75	2,65	4
KM20	9-KM20	143	62	130,8	110	18	72	2,95	4
KM21	9-KM21	153	62	140,8	110	18	72	3,20	4
KM22	9-KM22	158	62	145,8	110	18	72	3,35	4
KM23	9-KM23	165	62	150,8	110	18	72	3,60	4



3/8" □

Part No	D mm	d mm	id mm	L mm	t mm	T mm	kg	Tänder Teeth Zähne
GU0 1-GU0	22	22	18,3	57	8	44	0,10	4
GU1 1-GU1	26	22	21,4	57	8	44	0,11	4

1/2" □

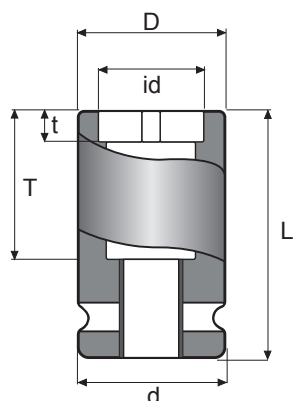

Part No	D mm	d mm	id mm	L mm	t mm	T mm	kg	Tänder Teeth Zähne
GU2 4-GU2	30	30	24,4	82	10	61	0,24	4
GU3 4-GU3	34	30	28,4	82	10	61	0,24	4
GU4 4-GU4	40	30	32,5	82	12	60	0,28	4
GU5 4-GU5	46	30	38,5	82	13	60	0,38	4
GU6 4-GU6	52	30	44,5	82	14	60	0,42	4
GU7 4-GU7	59	30	50,5	82	14	60	0,45	4
GU8 4-GU8	66	30	56,5	82	15	60	0,61	4

3/4" □

Part No	D mm	d mm	id mm	L mm	t mm	T mm	kg	Tänder Teeth Zähne
GU9 2-GU9	73	44	62,6	90	12	65	0,90	4
GU10 2-GU10	79	44	68,6	90	14	65	0,98	4
GU11 2-GU11	86	44	75,6	90	14	65	1,06	6
GU12 2-GU12	91	44	80,6	90	14	62	1,14	6
GU13 2-GU13	96	44	85,6	90	14	62	1,21	6

1" □





Part No	D mm	d mm	id mm	L mm	t mm	T mm	kg	Spår Slots Nuten
GU14 9-GU14	103	62	92,7	110	14	75	1,95	6
GU15 9-GU15	109	62	98,7	110	15	75	2,06	6
GU16 9-GU16	116	62	105,8	110	15	75	2,20	8
GU17 9-GU17	121	62	110,8	110	16	75	2,32	8
GU18 9-GU18	131	62	120,8	110	16	75	2,66	8
GU19 9-GU19	137	62	125,8	110	16	72	2,83	8
GU20 9-GU20	143	62	130,8	110	18	70	3,00	8

SPLINE DRIVE IMPACT SOCKETS

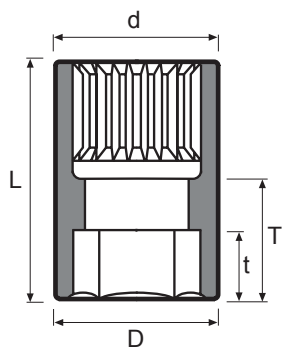

No. 5 Spline



		Part No	D mm	d mm	L mm	t mm	T mm	 kg
	30	7-30=1 3/16	48	60	80	17	38	1,00
	32	7-32	50	60	80	19	38	1,00
	33	7-33	53	60	80	19	38	1,00
	34	7-34	54	60	80	20	38	1,00
	36	7-36	57	60	80	20	38	1,00
	37	7-37	58	60	80	21	38	1,15
	38	7-38=1 1/2	59	60	80	21	38	1,15
	41	7-41	64	60	80	23	38	1,08
	43	7-43=1 11/16	66	60	100	24	58	1,48
	46	7-46=1 13/16	72	60	100	25	58	1,42
	47	7-47	74	60	100	26	58	1,44
	50	7-50	78	60	100	28	58	1,70
	52	7-52	80	60	100	30	58	1,80
	55	7-55	84	60	100	30	58	2,00
	56	7-56	84	60	100	30	58	2,10
	60	7-60	90	80	110	35	68	2,20
	65	7-65=2 9/16	97	80	120	35	78	2,70
	70	7-70=2 3/4	103	80	120	40	78	3,00
	1 3/16	7-30=1 3/16	48	60	80	17	38	1,00
	1 1/2	7-38=1 1/2	59	60	80	21	38	1,15
	1 11/16	7-43=1 11/16	66	60	100	24	58	1,48
	1 13/16	7-46=1 13/16	72	60	100	25	58	1,42
	2 9/16	7-65=2 9/16	97	80	120	35	78	2,70
	2 3/4	7-70=2 3/4	103	80	120	40	78	3,00

No. 5 Spline

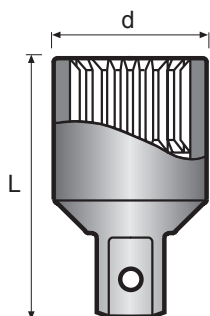

Part No

d
mmL
mm

kg

1 5/8

1

PA79

60

89

0,85

Mellanstycken

Adapters

Zwischenstücke

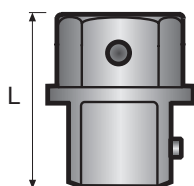

Part No

L
mm

kg

3/8

3/8

MS11

24

0,01

3/8

1/2

MS14

25

0,02

1/2

1/2

MS44

29,4

0,03



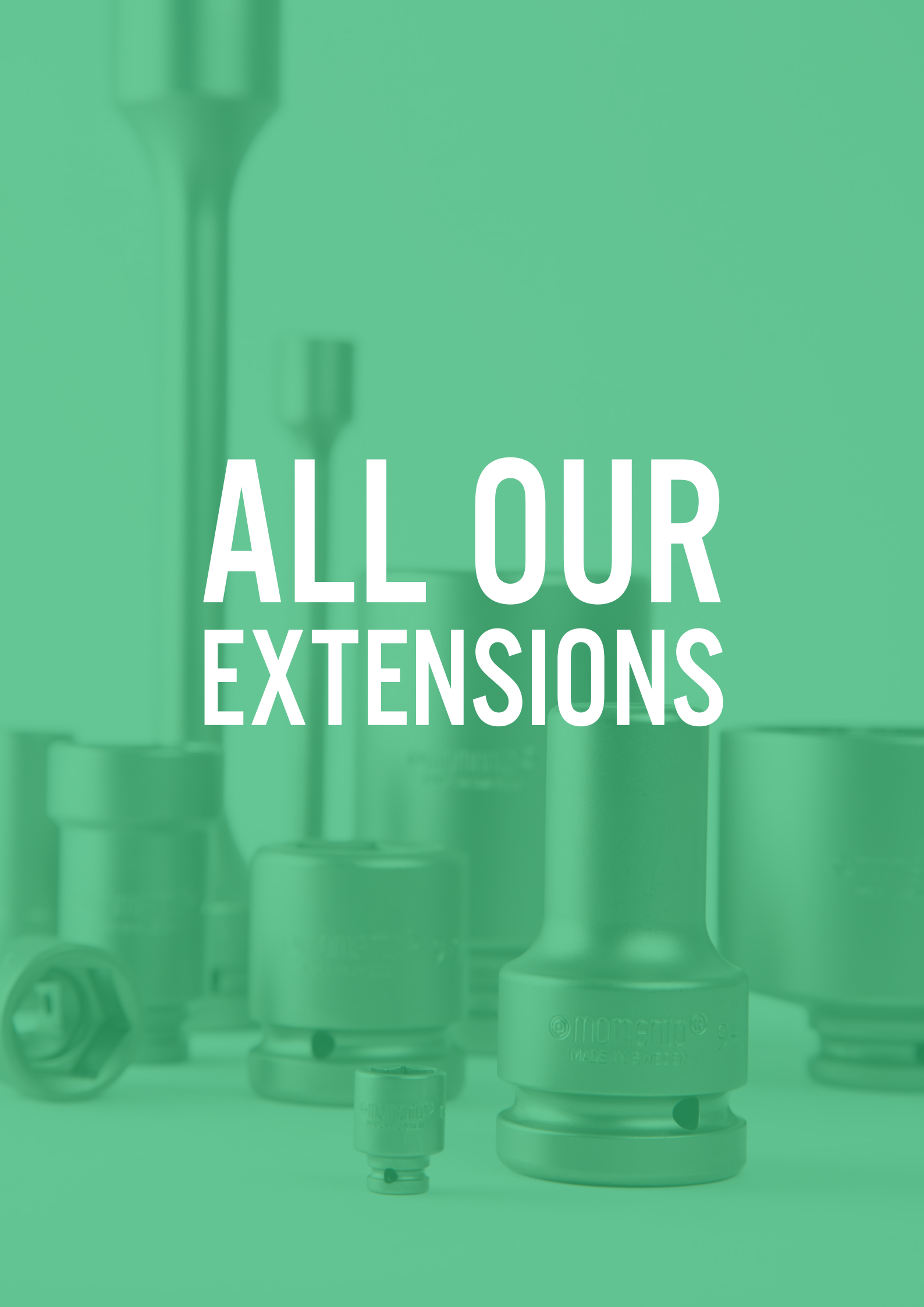

ALL OUR EXTENSIONS

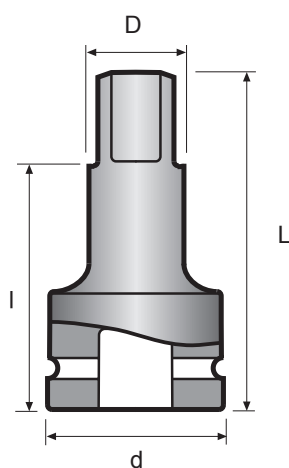



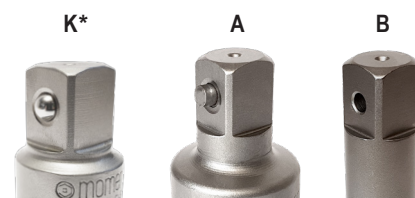

□	■	Part No	Model	D mm	d mm	L mm	l mm	kg
1/4	1/4	EB00-2	A	8,2	13	51	43,5	0,03
1/4	1/4	EB00-3	A	8,2	13	76	68,5	0,04
1/4	1/4	EB00-4	A	8,2	13	102	94,5	0,05
1/4	1/4	EB00-5	A	8,2	13	127	119,5	0,06
1/4	1/4	EB00-6	A	8,2	13	153	145,5	0,07
3/8	3/8	EB11-1 1/4	A	12,4	21,25	32	20	0,05
3/8	3/8	EB11-2	A	12,4	21,25	51	40	0,07
3/8	3/8	EB11-3	A	12,4	21,25	76	65	0,10
3/8	3/8	EB11-4	A	12,4	21,25	102	91	0,12
3/8	3/8	EB11-5	A	12,4	21,25	127	116	0,16
3/8	3/8	EB11-6	A	12,4	21,25	152	141	0,16
3/8	3/8	EB11-7	A	12,4	21,25	178	167	0,19
3/8	3/8	EB11-8	A	12,4	21,25	203	192	0,24
3/8	3/8	EB11-10	A	12,4	21,25	254	243	0,27
3/8	3/8	EB11-12	A	12,4	22	305	294	0,43
3/8	1/4	EB10-4	A	12,4	21,25	102	94,5	0,12
3/8	1/4	EB10-5	A	12,4	21,25	127	119,5	0,16
3/8	1/4	EB10-6	A	12,4	21,25	152	144,5	0,16
3/8	1/4	EB10-8	A	12,4	21,25	203	195,5	0,24



 * K: Våra 1/4", 3/8", 1/2" och 5/8" förlängare kan även fås med fjädrande kula som låsning, lägg till ett "K" efter artikelnumret för utförande med kula.

 * K: Our 1/4", 3/8", 1/2" and 5/8" extensions can also be supplied with spring ball as locking, add a "K" for the part number for the version with ball.

 * K: Unsere 1/4", 3/8", 1/2" und 5/8" verlängerungen können auch mit Federkugel als Verriegelung geliefert werden. Fügen Sie ein "K" für die Teilenummer der Version mit Kugel hinzu.

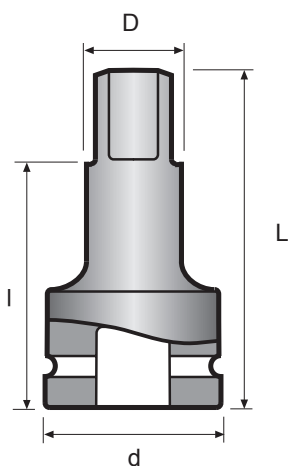

□	■	Part No	Model	D mm	d mm	L mm	l mm	kg
1/2	1/2	EB44-2	A	16,6	29	51	35,5	0,15
1/2	1/2	EB44-3	A	16,6	29	76	60,5	0,20
1/2	1/2	EB44-4	A	16,6	29	102	86,5	0,24
1/2	1/2	EB44-5	A	16,6	29	127	111,5	0,27
1/2	1/2	EB44-6	A	16,6	29	152	136,5	0,32
1/2	1/2	EB44-7	A	16,6	29	178	162,5	0,36
1/2	1/2	EB44-8	A	16,6	29	203	187,5	0,41
1/2	1/2	EB44-10	A	16,6	29	254	238,5	0,49
1/2	1/2	EB44-12	A	16,6	29	305	289,5	0,58
1/2	3/8	EB41-3	A	16,6	29	76	65	0,14
1/2	3/8	EB41-4	A	16,6	29	102	91	0,19
1/2	3/8	EB41-5	A	16,6	29	127	116	0,23
1/2	3/8	EB41-6	A	16,6	29	152	141	0,28
1/2	3/8	EB41-7	A	16,6	29	178	167	0,32
1/2	3/8	EB41-10	A	16,6	29	254	243	0,45
5/8	5/8	EB88-3	A	20,7	35	76	59,7	0,30
5/8	5/8	EB88-6	A	20,7	35	152	135,7	0,50
5/8	5/8	EB88-10	A	20,7	35	254	237,7	0,80

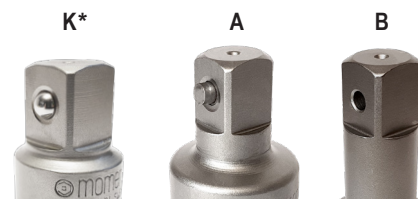

 * K: Våra 1/4", 3/8", 1/2" och 5/8" förlängare kan även fås med fjädrande kula som låsning, lägg till ett "K" efter artikelnumret för utförande med kula.

 * K: Our 1/4", 3/8", 1/2" and 5/8" extensions can also be supplied with spring ball as locking, add a "K" for the part number for the version with ball.

 * K: Unsere 1/4", 3/8", 1/2" und 5/8" verlängerungen können auch mit Federkugel als Verriegelung geliefert werden. Fügen Sie ein "K" für die Teilnummer der Version mit Kugel hinzu.

Can't find what you're looking for?

We can manufacture special tools to meet your individual requirements. Contact us and we will help you!

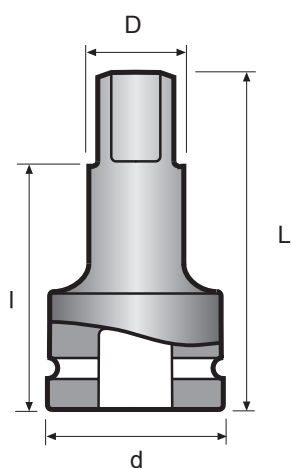

□	■	Part No	Model	D mm	d mm	L mm	l mm	kg
3/4	3/4	EB22-4	B	25,1	44	102	79	0,61
3/4	3/4	EB22-7	B	25,1	44	178	155	0,90
3/4	3/4	EB22-10	B	25,1	44	254	231	1,19
3/4	3/4	EB22-13	B	25,1	44	330	307	1,50
3/4	3/4	EB22-15	B	25,1	44	381	358	1,70
3/4	1/2	EB24-4	A	25,1	44	102	86,5	0,56
3/4	1/2	EB24-7	A	25,1	44	178	162,5	0,87
3/4	1/2	EB24-10	A	25,1	44	254	238,5	1,16
3/4	1/2	EB24-13	A	25,1	44	330	285,9	1,36
3/4	1/2	EB24-15	A	25,1	44	381	165,5	1,65
1	1	EB99-4	B	33,5	54	102	74	0,95
1	1	EB99-7	B	33,5	54	178	150	1,46
1	1	EB99-10	B	33,5	54	254	226	2,00
1	1	EB99-13	B	33,5	54	330	302	2,50
1	1	EB99-15	B	33,5	54	381	353	2,85
1 1/2	1 1/2	EB55-7	B	49,5	84	178	138,7	3,77
1 1/2	1 1/2	EB55-10	B	49,5	84	254	214,7	4,92
1 1/2	1 1/2	EB55-12	B	49,5	84	305	265,7	5,69
1 1/2	1 1/2	EB55-13	B	49,5	84	330	290,7	6,07
1 1/2	1 1/2	EB55-15	B	49,5	84	381	341,7	6,84
2 1/2	2 1/2	EB66-7	B	83,5	127	178	122,4	9,44
2 1/2	2 1/2	EB66-10	B	83,5	127	254	198,4	12,70
2 1/2	2 1/2	EB66-13	B	83,5	127	330	274,4	16,00
2 1/2	2 1/2	EB66-15	B	83,5	127	384	328,4	18,30

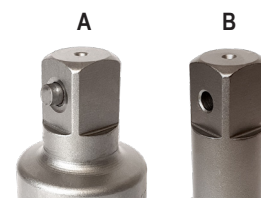

ALL OUR UNIVERSAL JOINTS



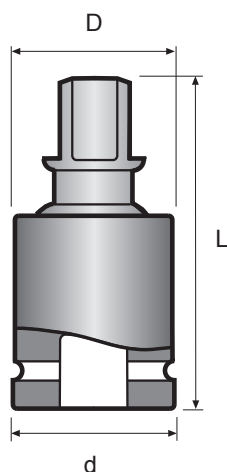

□	■	Part No	Mod.	D mm	d mm	L mm	kg
1/4	1/4	UK00 <small>SEPARATE DRAWING</small>	A	17	13	43	0,04
3/8	3/8	UK11S	A	25	22	52	0,09
3/8	3/8	UK11-IMP*	A	30	22	58	0,14
1/2	1/2	UK44S	A	30	28	63	0,17
1/2	1/2	UK44-IMP*	A	40	30	75	0,30
5/8	5/8	UK88	A	38	35	70	0,31

* Heavy duty version for use with impact tool



NON-IMPACT

UK11S, UK44S, UK88



IMPACT

UK11-IMP, UK44-IMP

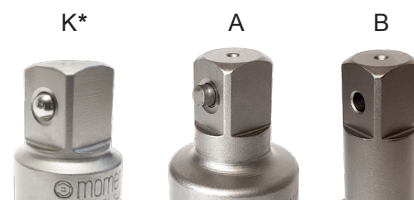

🇸🇪 * K: Våra 1/4", 3/8", 1/2" och 5/8" universalknutar kan även fås med fjädrande kula som låsning, lägg till ett "K" efter artikelnumret för utförande med kula.

🇬🇧 * K: Our 1/4", 3/8", 1/2" and 5/8" universal joints can also be supplied with spring ball as locking, add a "K" for the part number for the version with ball.

🇩🇪 * K: Unsere 1/4", 3/8", 1/2" und 5/8" Universalgelenke können auch mit Federkugel als Verriegelung geliefert werden. Fügen Sie ein "K" für die Teilenummer der Version mit Kugel hinzu.

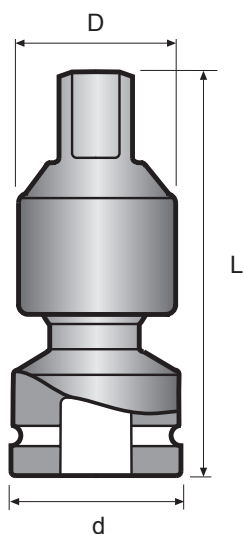

UK00



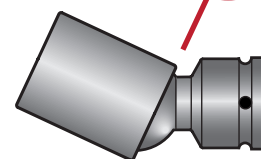

UK00

MAX 30° FOR MACHINE-POWERED TOOLS

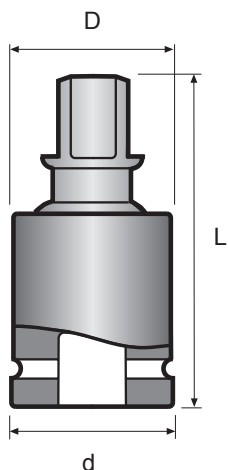



		Part No	Mod.	D mm	d mm	L mm	kg
3/4	3/4	UK22	B	46	44	90	0,59
3/4	3/4	UK22-IMP*	B	60	44	103	1,05
1	1	UK99	B	60	54	113	1,22
1 1/2	1 1/2	UK55	B	84	84	166	3,75

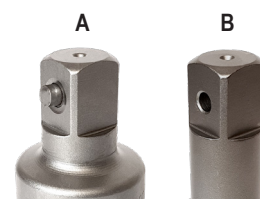

* Heavy duty version for use with impact tool



ALL OUR ADAPTERS

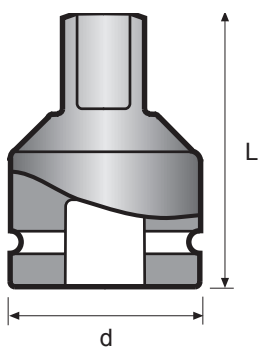



		Part No	Mod.	d mm	L mm	kg
1/4	3/8	PA01	A	13	28	0,02
3/8	1/4	PA10	A	21,25	31	0,05
3/8	1/2	PA14	A	21,25	35	0,06
1/2	3/8	PA41	A	25	35	0,06
1/2	5/8	PA48	A	29	43	0,13
1/2	3/4	PA42	B	29	43	0,13
5/8	1/2	PA84	A	35	49	0,18
5/8	3/4	PA82	B	35	54	0,23
3/4	1/2	PA24	A	44	52	0,29
3/4	5/8	PA28	A	44	52	0,30
3/4	1	PA29	B	44	60	0,40
1	3/4	PA92	B	54	67	0,53
1	1 1/4	PA93	B	64	82	1,12
1	1 1/2	PA95	B	64	85	1,26
1 1/2	1	PA59	B	84	88	1,75
1 1/2	1 1/4	PA53	B	84	88	1,76
1 1/2	2 1/2	PA56	B	102	120	5,00
2 1/2	1 1/2	PA65	B	127	125	5,57

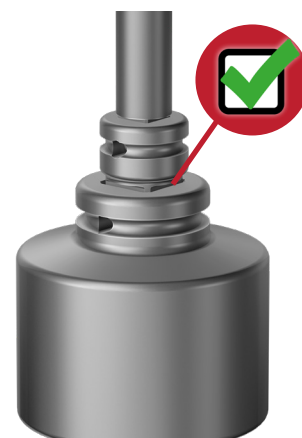
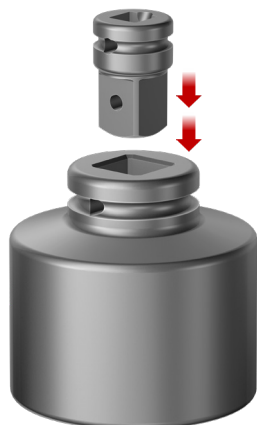

Övergångar

Adapters

Reduzierstücke

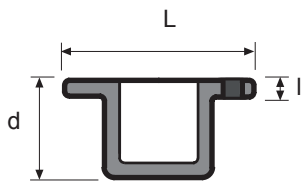

		Part No	d mm	L mm	l mm	 kg
1/4	3/8	IPA01	22	14	3	0,02
3/8	1/2	IPA14	30	18,5	3,5	0,03
1/2	3/4	IPA42	44	28	5	0,11
3/4	1	IPA29	54	33	5	0,16
1	1 1/2	IPA95	84	45	6	0,53
1 1/2	2 1/2	IPA56	127	65	10	2,35

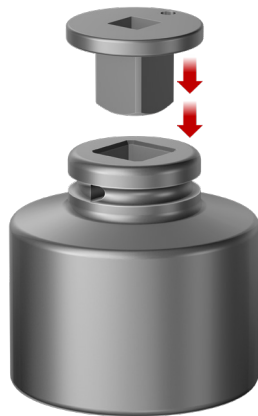

Mellanstycken

Adapters

Zwischenstücke

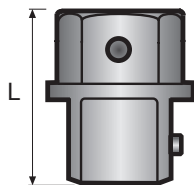

		Part No	L mm	 kg
3/8	3/8	MS11	24	0,01
3/8	1/2	MS14	25	0,02
1/2	1/2	MS44	29,4	0,03

BOLTING ACCESSORIES



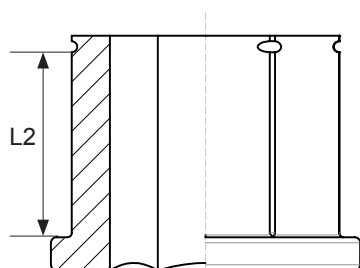
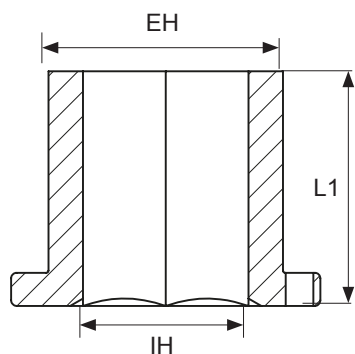

EH mm	IH mm	Part No	L1 mm	L2 mm
41	36	RI33 41/36	45	33
41	32	RI33 41/32	45	33
41	30	RI33 41/30	45	33
46	41	RI33 46/41	45	33
46	36	RI33 46/36	45	33
46	32	RI33 46/32	45	33
50	46	RI33 50/46	45	33
50	41	RI33 50/41	45	33
50	36	RI33 50/36	45	33
55	50	RI33 55/50	45	33
55	46	RI33 55/46	45	33
55	41	RI33 55/41	45	33
60	55	RI33 60/55	45	33
60	50	RI33 60/50	45	33
60	46	RI33 60/46	45	33
41	36	RI44 41/36	55	42
50	46	RI44 50/46	55	42
50	41	RI44 50/41	55	42
50	36	RI44 50/36	55	42
55	50	RI44 55/50	55	42
55	46	RI44 55/46	55	42
55	41	RI44 55/41	55	42
60	55	RI44 60/55	55	42
60	50	RI44 60/50	55	42
60	46	RI44 60/46	55	42
65	60	RI44 65/60	55	42
65	55	RI44 65/55	55	42
65	50	RI44 65/50	55	42
70	65	RI44 70/65	55	42
70	60	RI44 70/60	55	42
70	55	RI44 70/55	55	42
75	70	RI44 75/70	55	42
75	65	RI44 75/65	55	42
75	60	RI44 75/60	55	42
80	75	RI44 80/75	55	42
80	70	RI44 80/70	55	42
80	65	RI44 80/65	55	42

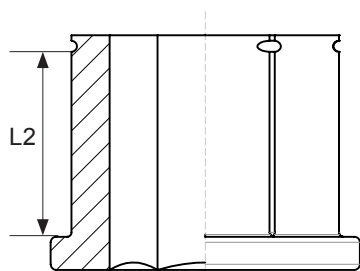
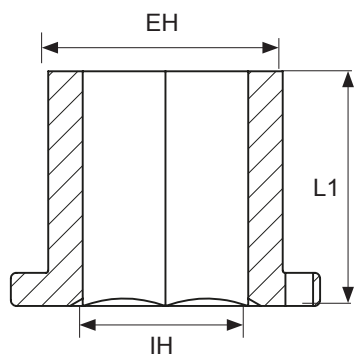

EH mm	IH mm	Part No	L1 mm	L2 mm
55	50	RI56 55/50	70	55
55	46	RI56 55/46	70	55
55	41	RI56 55/41	70	55
60	55	RI56 60/55	70	55
60	50	RI56 60/50	70	55
60	46	RI56 60/46	70	55
65	60	RI56 65/60	70	55
65	55	RI56 65/55	70	55
65	50	RI56 65/50	70	55
70	65	RI56 70/65	70	55
70	60	RI56 70/60	70	55
70	55	RI56 70/55	70	55
75	70	RI56 75/70	70	55
75	65	RI56 75/65	70	55
75	60	RI56 75/60	70	55
80	75	RI56 80/75	70	55
80	70	RI56 80/70	70	55
80	65	RI56 80/65	70	55
85	80	RI56 85/80	70	55
85	75	RI56 85/75	70	55
85	70	RI56 85/70	70	55
90	85	RI56 90/85	70	55
90	80	RI56 90/80	70	55
90	75	RI56 90/75	70	55
95	90	RI56 95/90	70	55
95	85	RI56 95/85	70	55
95	80	RI56 95/80	70	55
100	95	RI56 100/95	70	55
100	90	RI56 100/90	70	55
100	85	RI56 100/85	70	55

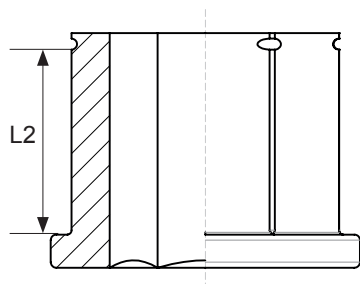
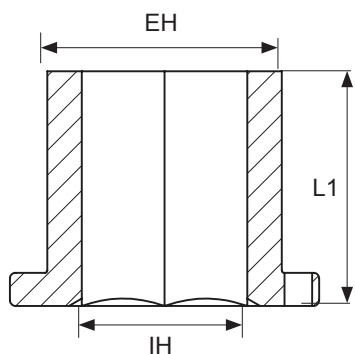

EH mm	IH mm	Part No	L1 mm	L2 mm
80	75	RI67 80/75	85	67
80	70	RI67 80/70	85	67
80	65	RI67 80/65	85	67
85	80	RI67 85/80	85	67
85	75	RI67 85/75	85	67
85	70	RI67 85/70	85	67
90	85	RI67 90/85	85	67
90	80	RI67 90/80	85	67
90	75	RI67 90/75	85	67
95	90	RI67 95/90	85	67
95	85	RI67 95/85	85	67
95	80	RI67 95/80	85	67
100	95	RI67 100/95	85	67
100	90	RI67 100/90	85	67
100	85	RI67 100/85	85	67
105	100	RI67 105/100	85	67
105	95	RI67 105/95	85	67
105	90	RI67 105/90	85	67
110	105	RI67 110/105	85	67
110	100	RI67 110/100	85	67
110	95	RI67 110/95	85	67
115	110	RI67 115/110	85	67
115	105	RI67 115/105	85	67
115	100	RI67 115/100	85	67
120	115	RI67 120/115	85	67
120	110	RI67 120/110	85	67
120	105	RI67 120/105	85	67
125	120	RI67 125/120	85	67
125	115	RI67 125/115	85	67
125	110	RI67 125/110	85	67
130	125	RI67 130/125	85	67
130	120	RI67 130/120	85	67
130	115	RI67 130/115	85	67

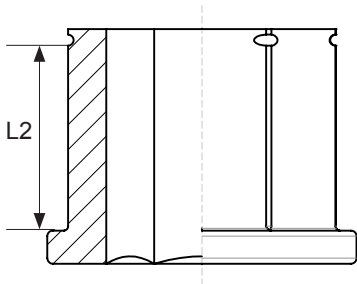
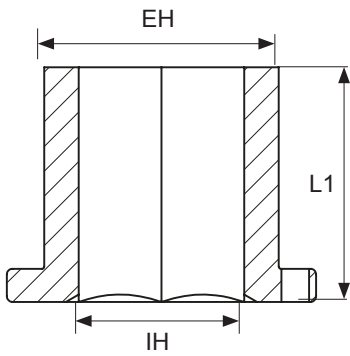

EH inch	IH inch	Part No inch	L1 mm	L2 mm
1 7/16	1 1/4	RI33 107/104F	45	33
1 5/8	1 7/16	RI33 110/107F	45	33
1 5/8	1 1/4	RI33 110/104F	45	33
1 13/16	1 5/8	RI33 113/110F	45	33
1 13/16	1 7/16	RI33 113/107F	45	33
2	1 13/16	RI33 200/113F	45	33
2	1 5/8	RI33 200/110F	45	33
2 3/16	2	RI33 203/200F	45	33
2 3/16	1 13/16	RI33 203/113F	45	33
2 3/8	2 3/16	RI33 206/203F	45	33
2 3/8	2	RI33 206/200F	45	33
1 13/16	1 5/8	RI44 113/110F	55	42
2	1 13/16	RI44 200/113F	55	42
2	1 5/8	RI44 200/110F	55	42
2 3/16	2	RI44 203/200F	55	42
2 3/16	1 13/16	RI44 203/113F	55	42
2 3/8	2 3/16	RI44 206/203F	55	42
2 3/8	2	RI44 206/200F	55	42
2 9/16	2 3/8	RI44 209/206F	55	42
2 9/16	2 3/16	RI44 209/203F	55	42
2 3/4	2 9/16	RI44 212/209F	55	42
2 3/4	2 3/8	RI44 212/206F	55	42
2 15/16	2 3/4	RI44 215/212F	55	42
2 15/16	2 9/16	RI44 215/209F	55	42
3 1/8	2 15/16	RI44 302/215F	55	42
3 1/8	2 3/4	RI44 302/212F	55	42



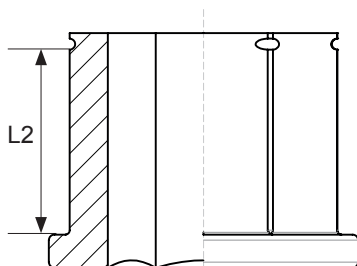
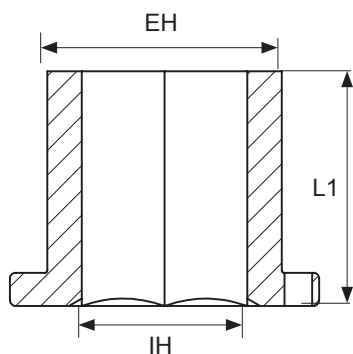

EH inch	IH inch	Part No inch	L1 mm	L2 mm
2 3/16	2	RI56 203/200F	70	55
2 3/16	1 13/16	RI56 203/113F	70	55
2 3/8	2 3/16	RI56 206/203F	70	55
2 3/8	2	RI56 206/200F	70	55
2 9/16	2 3/8	RI56 209/206F	70	55
2 9/16	2 3/16	RI56 209/203F	70	55
2 3/4	2 9/16	RI56 212/209F	70	55
2 3/4	2 3/8	RI56 212/206F	70	55
2 15/16	2 3/4	RI56 215/212F	70	55
2 15/16	2 9/16	RI56 215/209F	70	55
3	2 3/4	RI56 300/212F	70	55
3	2 15/16	RI56 300/209F	70	55
3 1/8	2 15/16	RI56 302/215F	70	55
3 1/8	2 3/4	RI56 302/212F	70	55
3 3/8	3	RI56 306/300F	70	55
3 3/8	2 15/16	RI56 306/215F	70	55
3 1/2	3 1/8	RI56 308/302F	70	55
3 1/2	3	RI56 308/300F	70	55
3 3/4	3 1/2	RI56 312/308F	70	55
3 3/4	3 3/8	RI56 312/306F	70	55
3 7/8	3 1/2	RI56 314/308F	70	55
3 7/8	3 3/8	RI56 314/306F	70	55
3 1/8	2 15/16	RI67 302/215F	85	67
3 1/8	2 3/4	RI67 302/212F	85	67
3 3/8	3 1/8	RI67 306/302F	85	67
3 3/8	3	RI67 306/300F	85	67
3 1/2	3 1/8	RI67 308/302F	85	67
3 1/2	3	RI67 308/300F	85	67
3 3/4	3 1/2	RI67 312/308F	85	67
3 3/4	3 3/8	RI67 312/306F	85	67
3 7/8	3 1/2	RI67 314/308F	85	67
3 7/8	3 3/8	RI67 314/306F	85	67
4 1/8	3 7/8	RI67 402/314F	85	67
4 1/8	3 3/4	RI67 402/312F	85	67
4 1/4	3 7/8	RI67 404/314F	85	67
4 1/4	3 3/4	RI67 404/312F	85	67
4 5/8	4 1/4	RI67 410/404F	85	67
4 5/8	4 1/8	RI67 410/402F	85	67
5	4 5/8	RI67 500/410F	85	67
5	4 1/4	RI67 500/404F	85	67
4 5/8	3 7/8	RI67 410/314F	85	67
4 5/8	3 3/4	RI67 410/312F	85	67

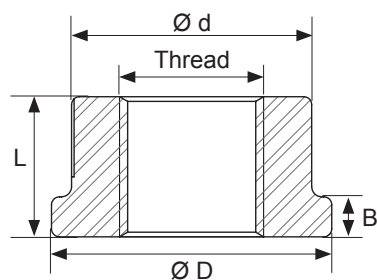

D mm	d mm	L mm	B mm	Part No mm	A/F mm	Thread mm
45	45	35	-	SN24	36	M 24
52	45	35	10	SN27	41	M 27
58	55	35	10	SN30	46	M 30
63	55	35	10	SN33	50	M 33
70	60	40	15	SN36	55	M 36
75	60	40	15	SN39	60	M 39
82	65	40	15	SN42	65	M 42
88	70	45	20	SN45	70	M 45
95	70	45	20	SN48	75	M 48
100	75	45	20	SN52	80	M 52
120	85	50	25	SN64	95	M 64

D mm	d mm	L mm	B mm	Part No inch	A/F inch	Thread inch
45	45	35	-	SN 7/8	1 7/16	7/8
52	45	35	10	SN 1	1 5/8	1
58	55	35	10	SN 1 1/8	1 13/16	1 1/8
63	55	35	10	SN 1 1/4	2	1 1/4
70	60	40	15	SN 1 3/8	2 3/16	1 3/8
75	60	40	15	SN 1 1/2	2 3/8	1 1/2
82	65	40	15	SN 1 5/8	2 9/16	1 5/8
88	70	45	20	SN 1 3/4	2 3/4	1 3/4
95	70	45	20	SN 1 7/8	2 15/16	1 7/8
100	75	45	20	SN 2	3 1/8	2
120	85	50	25	SN 2 1/2	3 3/4	2 1/2



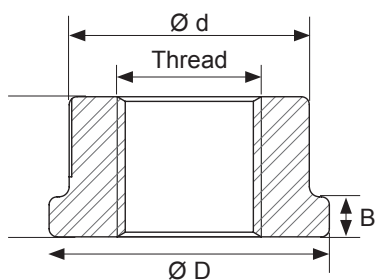



D mm	d mm	L mm	B mm	Part No mm	A/F mm	Thread mm
45	45	35	-	SN24	36	M 24
52	45	35	10	SN27	41	M 27
58	55	35	10	SN30	46	M 30
63	55	35	10	SN33	50	M 33
70	60	40	15	SN36	55	M 36
75	60	40	15	SN39	60	M 39
82	65	40	15	SN42	65	M 42
88	70	45	20	SN45	70	M 45
95	70	45	20	SN48	75	M 48
100	75	45	20	SN52	80	M 52
120	85	50	25	SN64	95	M 64

D mm	d mm	L mm	B mm	Part No inch	A/F inch	Thread inch
45	45	35	-	SN 7/8	1 7/16	7/8
52	45	35	10	SN 1	1 5/8	1
58	55	35	10	SN 1 1/8	1 13/16	1 1/8
63	55	35	10	SN 1 1/4	2	1 1/4
70	60	40	15	SN 1 3/8	2 3/16	1 3/8
75	60	40	15	SN 1 1/2	2 3/8	1 1/2
82	65	40	15	SN 1 5/8	2 9/16	1 5/8
88	70	45	20	SN 1 3/4	2 3/4	1 3/4
95	70	45	20	SN 1 7/8	2 15/16	1 7/8
100	75	45	20	SN 2	3 1/8	2
120	85	50	25	SN 2 1/2	3 3/4	2 1/2

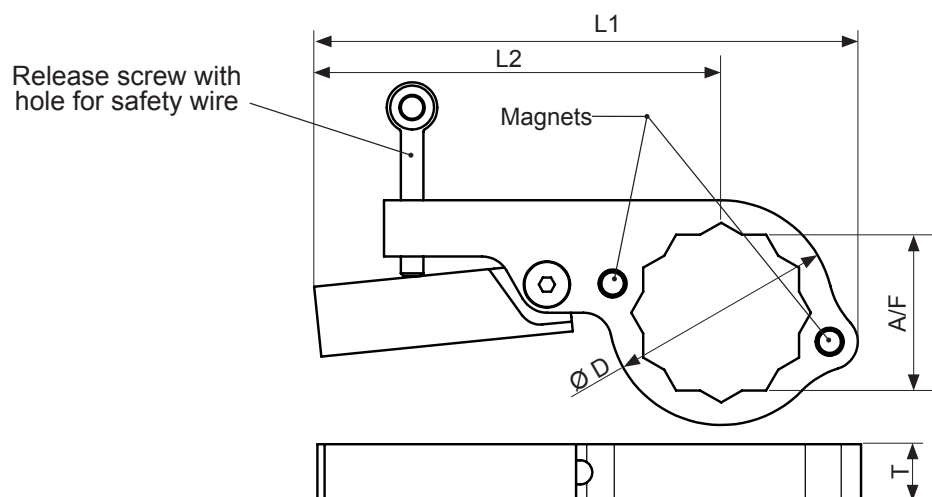
Part No	L1 mm	L2 mm	D mm	T mm	A/F mm	Part No inch	A/F inch	Weight kg
BUW 30 = 1 3/16	133	103	46	15	30	BUW 30 = 1 3/16	1 3/16	0,4
BUW 32	136	105	48	15	32	BUW 1 1/4	1 1/4	0,4
BUW 36	144	110	54	15	36	BUW 1 7/16	1 7/16	0,5
BUW 41	153	115	62	15	41	BUW 1 5/8	1 5/8	0,55
BUW 46 = 1 13/16	181	139	68	20	46	BUW 46 = 1 13/16	1 13/16	1,0
BUW 50	188	142	75	20	50	BUW 2	2	1,05
BUW 55	193	145	80	20	55	BUW 2 3/16	2 3/16	1,1
BUW 60	199	148	86	20	60	BUW 2 3/8	2 3/8	1,15
BUW 65 = 2 9/16	222	164	96	20	65	BUW 65 = 2 9/16	2 9/16	1,55
BUW 70 = 2 3/4	249	187	102	25	70	BUW 70 = 2 3/4	2 3/4	2,4
BUW 75	256	190	110	25	75	BUW 2 15/16	2 15/16	2,5
BUW 75	256	190	110	25	75	BUW 3	3	2,5
BUW 80	264	194	118	25	80	BUW 3 1/8	3 1/8	2,7
BUW 85	288	214	124	30	85	BUW 3 3/8	3 3/8	4
BUW 90	312	235	130	30	90	BUW 3 1/2	3 1/2	4,5
BUW 95 = 3 3/4	322	240	140	30	95	BUW 95 = 3 3/4	3 3/4	4,8
BUW 100	360	270	50	40	100	BUW 3 7/8	3 7/8	8,0
BUW 105 = 4 1/8	365	273	155	40	105	BUW 105 = 4 1/8	4 1/8	8,1
BUW 110	380	285	162	40	110	BUW 4 1/4	4 1/4	9,1
BUW 115	388	289	170	40	115	BUW 4-19/32	4-19/32	9,5
BUW 120	395	292	177	40	120	BUW 4 5/8	4 5/8	9,9





1000V
 ISOLATED POWER ADAPTER

momento

MOMENTO ePROOF SYSTEM
PROTECTING YOU FROM ELECTRIC SHOCK

You are now holding an **Isolated Power Adapter** in your hand. This item has been tested and cleared with **10 000V – FOR YOUR SAFETY!**

TESTED BY OPERATOR: _____ DATE: _____

WARNING: ELECTRICAL ISOLATION DEVICE Provides protection against electrical faults and shock hazards up to 1000V. Ensure correct installation and regular inspection. Warranty and safety compliance are void if the product is altered, modified, or repaired by unauthorized individuals. Use only as directed, follow manufacturer guidelines, and do not disassemble or tamper with any components. Do not use if you notice any irregularities, damage, or unusual behavior in operation. Do not store in direct sunlight.

momento

MOMENTO ePROOF SYSTEM
PROTECTING YOU FROM ELECTRIC SHOCK

You are now holding an **Isolated Power Adapter** combined with a **Silverline™** cover socket. This item has been tested and cleared with **5000V – FOR YOUR SAFETY!**

TESTED BY OPERATOR: *John Doe* DATE: _____

WARNING: ELECTRICAL ISOLATION DEVICE Provides protection against electrical faults and shock hazards up to 1000V. Ensure correct installation and regular inspection. Warranty and safety compliance are void if the product is altered, modified, or repaired by unauthorized individuals. Use only as directed, follow manufacturer guidelines, and do not disassemble or tamper with any components. Do not use if you notice any irregularities, damage, or unusual behavior in operation. Do not store in direct sunlight.

Each adapters is individually tested for approval, quality certificate is included.

ePROOF SYSTEM

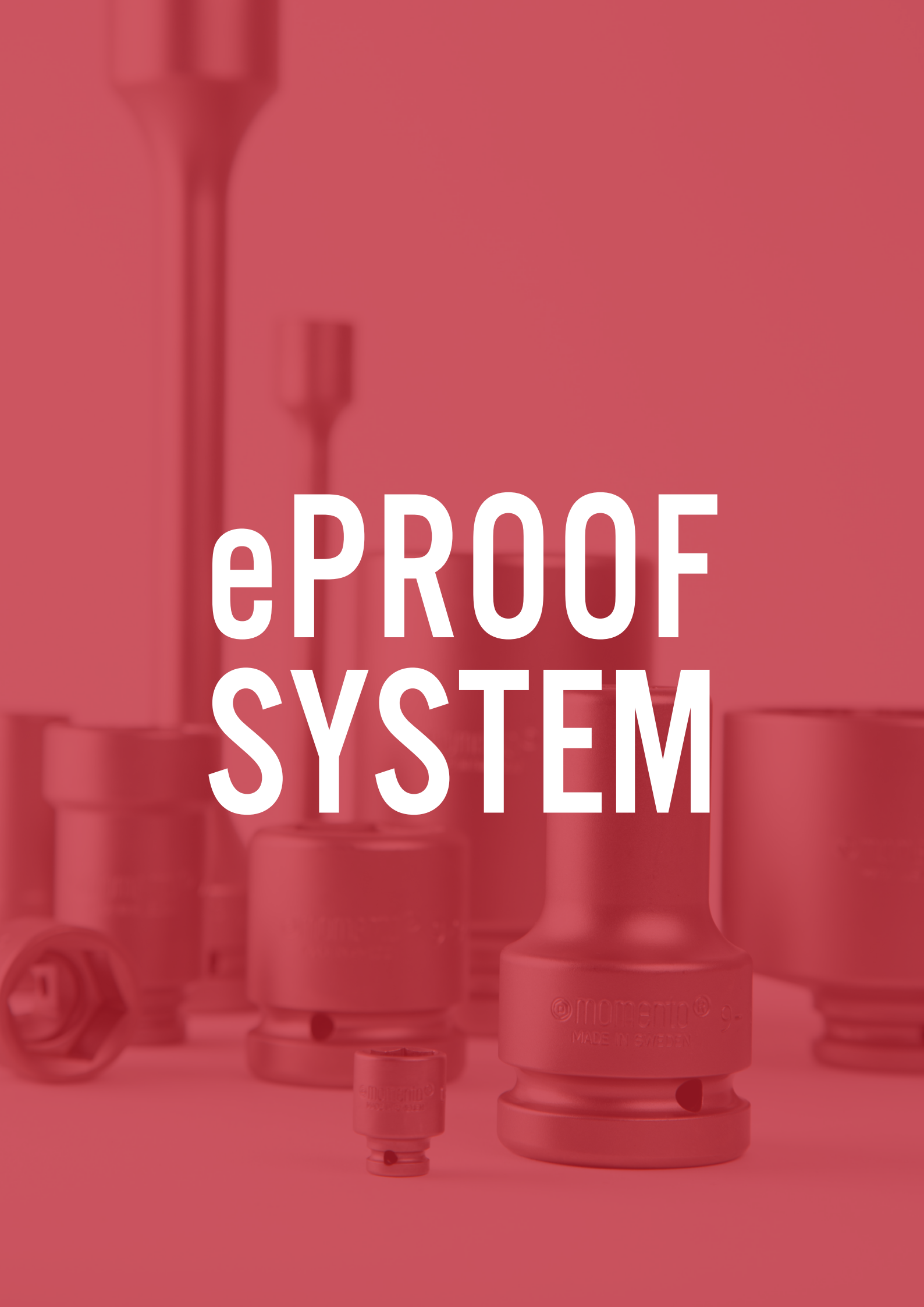

Momento isolerade adaptrar

Momento ePROOF SYSTEM isolerade adaptrar ger skydd mot elektrostatisk urladdning upp till 1000 V och minskar riskerna som är förknippade med höga strömmar, spänningssatta komponenter, kortslutningar och jordfel vid arbete med handverktyg.

Alla våra ePROOF SYSTEM-adaptrar har genomgått en test för att garantera din säkerhet. Med Momento kan du arbeta med full tillit, i vetskap om att våra isolerade strömadaptrar är konstruerade för att skydda dig mot elektriska stötar och andra elrelaterade risker. Vårt engagemang för säkerhet är kompromisslöst, och våra produkter är utvecklade för att uppfylla de mest krävande industristandarderna. Från elingenjörer till servicetekniker – våra adaptrar används med stor tillit av yrkesproffs över hela världen

Momento Isolated Power Adapters

Momento ePROOF SYSTEM Insulated/Isolated Adapters provide protection against electrostatic discharge up to 1000V, reducing risks associated with high currents, live components, short-circuits, and grounding with tools.

All our ePROOF SYSTEM adapters have been tested for your safety. With Momento you can work with confidence, knowing that our isolated power adapters are designed to protect you from electrical shock hazards. Our commitment to safety is unwavering, and our products are engineered to meet the most stringent industry standards. From electrical engineers to technicians, our power adapters are trusted by professionals worldwide.

Momento Isolierte Power Adapter

Die isolierten Adapter des Momento ePROOF SYSTEMS bieten Schutz vor elektrostatischer Entladung bis zu 1000 V und reduzieren Risiken im Zusammenhang mit hohen Stromstärken, spannungsführenden Komponenten, Kurzschlüssen sowie unbeabsichtigter Erdung über Werkzeuge.

Alle Adapter des ePROOF SYSTEMS wurden umfassend geprüft und getestet, um höchste Sicherheitsstandards zu gewährleisten. Mit Momento arbeiten Sie mit maximaler Sicherheit – unsere isolierten Power Adapter sind speziell dafür entwickelt, Anwender zuverlässig vor den Gefahren elektrischer Stromschläge zu schützen.

Sicherheit steht bei uns an oberster Stelle. Unsere Produkte werden nach strengsten industriellen Anforderungen entwickelt und gefertigt. Ob Elektroingenieur oder Servicetechniker – die Power Adapter von Momento genießen weltweit das Vertrauen von Fachkräften.



SAFETY AND
PROTECTION
@ WORK

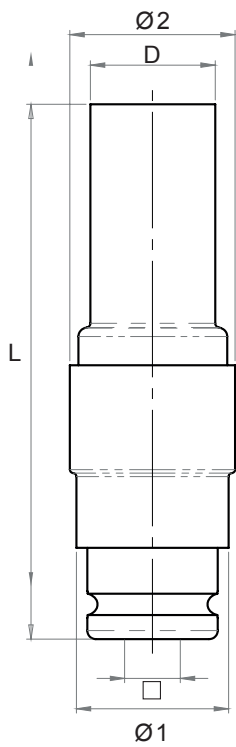

□	Part No	D mm	L mm	Ø 1	Ø 2	A/F size
	1/4" SI0-5	13	57	24	19,5	5
	1/4" SI0-6	14	57	24	19,5	6
	1/4" SI0-7	15	57	24	19,5	7
	1/4" SI0-8	16,5	57	24	19,5	8
	1/4" SI0-5L	13	89	24	19,5	5
	1/4" SI0-6L	14	89	24	19,5	6
	1/4" SI0-7L	15	89	24	19,5	7
	1/4" SI0-8L	16,5	89	24	19,5	8

	Part No	D mm	L mm	Ø 1	Ø 2	A/F size
	3/8" SI1-6	14	69	29	26	6
	3/8" SI1-7	16	69	29	26	7
	3/8" SI1-8	18	69	29	26	8
	3/8" SI1-9	19	69	29	26	9
	3/8" SI1-10	20	69	29	26	10
	3/8" SI1-11	22	69	29	26	11
	3/8" SI1-12	23	69	29	26	12
	3/8" SI1-6L	14	92	29	26	6
	3/8" SI1-7L	16	92	29	26	7
	3/8" SI1-8L	18	92	29	26	8
	3/8" SI1-9L	19	92	29	26	9
	3/8" SI1-10L	20	92	29	26	10
	3/8" SI1-11L	22	92	29	26	11
	3/8" SI1-12L	23	92	29	26	12
	3/8" SI1-13	24	69	29	29	13
	3/8" SI1-14	25	69	29	29	14
	3/8" SI1-13L	24	92	29	29	13
	3/8" SI1-14L	25	92	29	29	14

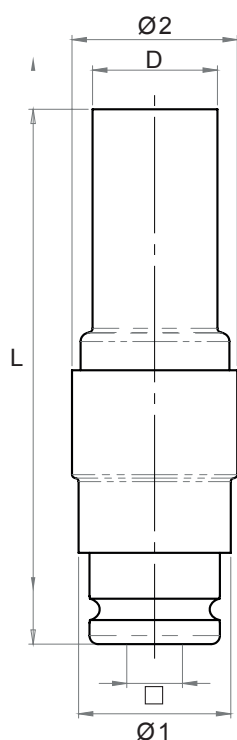

	Part No	D mm	L mm	Ø 1	Ø 2	A/F size
1/2"	SI4-6	16	80	35	33	6
1/2"	SI4-7	17	80	35	33	7
1/2"	SI4-8	19	80	35	33	8
1/2"	SI4-9	20	80	35	33	9
1/2"	SI4-10	21	80	35	33	10
1/2"	SI4-11	23	80	35	33	11
1/2"	SI4-12	24	80	35	33	12
1/2"	SI4-13	25	80	35	33	13
1/2"	SI4-14	27	80	35	33	14
1/2"	SI4-6L	16	123	35	33	6
1/2"	SI4-7L	17	123	35	33	7
1/2"	SI4-8L	19	123	35	33	8
1/2"	SI4-9L	20	123	35	33	9
1/2"	SI4-10L	21	123	35	33	10
1/2"	SI4-11L	23	123	35	33	11
1/2"	SI4-12L	24	123	35	33	12
1/2"	SI4-13L	25	123	35	33	13
1/2"	SI4-14L	27	123	35	33	14
1/2"	SI4-15	28	80	35	38	15
1/2"	SI4-16	29	80	35	38	16
1/2"	SI4-15L	28	123	35	38	15
1/2"	SI4-16L	29	123	35	38	16



1000V

Tested and certified according to applicable clauses in SS-EN IEC 60900

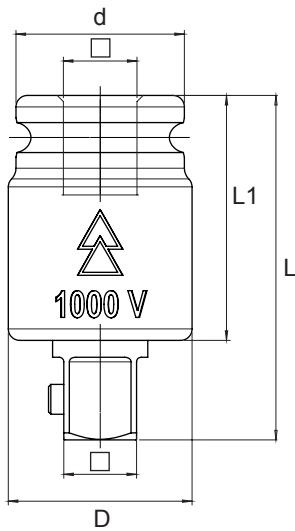

□	Part No	D mm	d mm	L mm	L1 mm	Nm	
	1/4"	SI00	19	16	39	30	30
	3/8"	SI11	24	22	45	32	110
	1/4"	SI44	30	30	55	37	220

MOMENTO ePROOF SYSTEM



The tools have a composite shell to delete all electric conductivity. The isolated power adapter can be combined with the Silverline™ cover sockets, and the gap cover for a fully integrated system by free-rotating sleeves.



1000V
IEC 60900:2004
 TESTED AND CERTIFIED
 ACCORDING TO APPLICABLE
 CLAUSES IN SS-EN IEC 60900



WARNING: ELECTRICAL ISOLATION DEVICE Provides protection against electrical faults and shock hazards up to 1000V. Ensure correct installation and regular inspection. Warranty and safety compliance are void if the product is altered, modified, or repaired by unauthorized individuals. Use only as directed, follow manufacturer guidelines, and do not disassemble or tamper with any components. Do not use if you notice any irregularities, damage, or unusual behavior in operation. Do not store in direct sunlight.

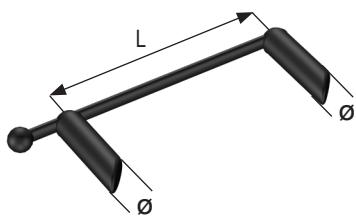

**LOCKING
PINS
RINGS
RET-RINGS**

Momento Locking



		Part No	L mm	Ø mm	kg
3/4" (2)	All sizes	RRK177004	60	5	0,001
1" (9)	17 - 52				
	3/4 - 2 1/6	RRK177001	74	5,5	0,002
1" (9)	53 - 70				
	2 1/8 - 2 3/4	RRK177002	86,5	5,5	0,002



Ett sätt att säkra verktyget är Momento locking, som är pinne och ring i ett stycke.



One way of securing the tool is Momento locking, which combines ring and pin in one unit.



Mit Momento locking, eine Kombination von Stift und Ring, kann das Werkzeug auch gesichert werden.

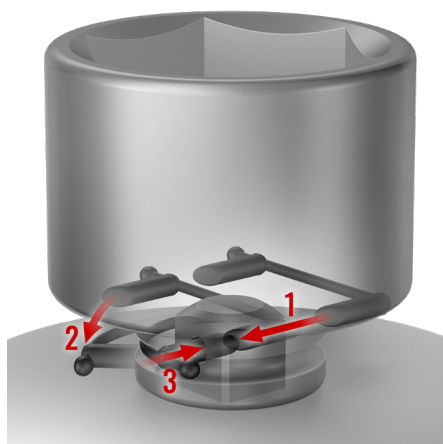

SAFETY FIRST!

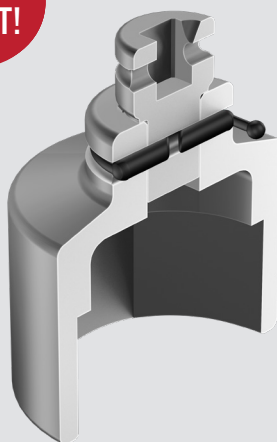

Den korta tid det tar att montera Momento Locking är ett litet pris för säkra arbetsförhållanden!



The short time it takes to fit Momento locking is a small price to pay for safe working conditions!



Die kurze Zeitspanne, die zur Montage von Momento Locking benötigt wird, steht in keinem Verhältnis zum Gewinn an Arbeitssicherheit!

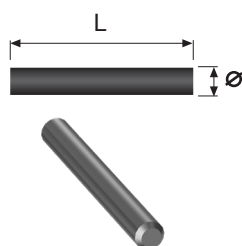

□	⬡	Part No	L mm	ø mm	kg
1/4" (0)	4-14	P-10	10	1,5	0,001
3/8" (1)	6-19	P-16	16	3	0,001
	21-24	P-20	20	4	0,001
1/2" (4)	10-14	P-20	20	4	0,001
	15-30	P-25	25	4	0,001
	32-36	P-35	35	4	0,004
5/8" (8)	14-36	P-30	30	4	0,002
3/4" (2)	16-65	P-35	35	4	0,004
1" (9)	19-52	P-45	45	5	0,007
	55-70	P-50	50	5	0,008
	75-100	P-60	60	5	0,011
1 1/2" (5)	35-90	P-70	70	6	0,016
	95-155	P-90	90	6	0,020
2 1/2" (6)	60-115	P-112	112	8	0,045
	120-255	P-145	145	8	0,065
3 1/2" (12)	105-175	P-175	175	12	0,155
	180-255	P-210	210	12	0,185

SAFETY FIRST!



Många mutterdagare fordrar låspinne och O-ring för att säkra verktyget.

Momentos krafthylsor och tillbehör är därför försedda med hål för låspinnen och spår för O-ringen.

Den korta tid det tar att montera låspinnen och O-ringen är ett litet pris för säkra arbetsförhållanden!



Many nutrunners and impact wrenches require a locking pin and a retaining ring to secure the tool.

Momento's sockets and accessories therefore have a hole for the locking pin and a groove for the retaining ring.

The short time it takes to fit the locking pin and the retaining ring is a small price to pay for safe working conditions!





Kraftsteckwerkzeuge müssen oft mit einem Sicherungsstift und einem O-Ring gesichert werden.

Momento Kraftsteckwerkzeuge sind daher mit einer Bohrung für den Stift und einer Nute für den O-Ring versehen.

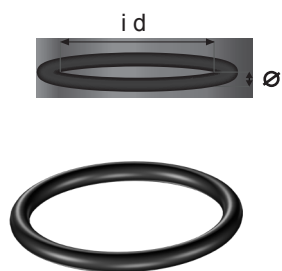
Die kurze Zeitspanne, die zur Montage von Stift und O-Ring benötigt wird, steht in keinem Verhältnis zum Gewinn an Arbeitssicherheit!



			Part No	i d mm	ø mm	kg
1/4" (0)		4-14	R-9	9	2,5	0,001
3/8" (1)		6-12	R-16	16	3,5	0,001
		13-19	R-19	19	4	0,001
		21-24	R-24	24	4	0,001
1/2" (4)		8-14	R-19	19	4	0,001
		15-30	R-24	24	4	0,002
		32-46	R-36	36	5	0,003
5/8" (8)		14-36	R-28	28	4	0,002
3/4" (2)		12-85	R-36	36	5	0,003
1" (9)		17-52	R-45	45	7	0,007
		55-70	R-54	54	7	0,011
		75-120	R-68	68	7	0,026
1 1/2" (5)		22-90	R-75	75	10	0,030
		95-155	R-90	90	10	0,060
2 1/2" (6)		50-115	R-116	115	9	0,035
		120-255	R-148	147	12	0,120
3 1/2" (12)		105-175	R-185	185	14	0,140
		180-255	R-220	220	14	0,170



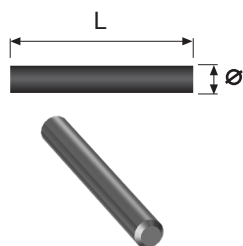

	□	■	Part No	L mm	ø mm	kg
	1/4" (0)	1/4" - 3/8"	P-10	10	1,5	0,001
	3/8" (1)	1/4" - 1/2"	P-16	16	3	0,001
	1/2" (4)	3/8" - 1/2"	P-20	20	4	0,001
		5/8" - 3/4"	P-25	25	4	0,001
	5/8" (8)	1/2" - 3/4"	P-30	30	4	0,002
	3/4" (2)	1/2" - 1"	P-35	35	4	0,004
	1" (9)	3/4" - 1"	P-45	45	5	0,007
		1 1/4" - 1 1/2"	P-50	50	5	0,008
1 1/4" (3)		1"	P-50	50	5	0,008
		1 1/2"	P-60	60	6	0,014
1 1/2" (5)		1" - 1 1/2"	P-70	70	6	0,016
		2 1/2"	P-90	90	6	0,020
2 1/2" (6)		1 1/2" - 2 1/2"	P-112	112	8	0,045

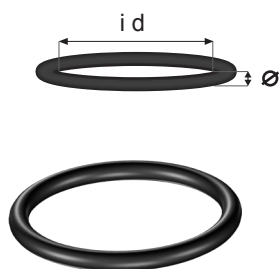

	□	■	Part No	i d mm	ø mm	kg
	1/4" (0)	1/4" - 3/8"	R-9	9	2,5	0,001
	3/8" (1)	1/4" - 1/2"	R-16	16	3,5	0,001
	1/2" (4)	3/8"	R-19	19	3,5	0,001
		1/2" - 3/4"	R-24	24	3,5	0,002
			R-22			0,001
	5/8" (8)	1/2" - 3/4"	R-28	28	4	0,002
	3/4" (2)	1/2" - 1"	R-36	36	5	0,003
	1" (9)	3/4" - 1"	R-45	45	7	0,007
		1 1/4" - 1 1/2"	R-54	54	7	0,011
1 1/4" (3)		1"	R-54	54	7	0,011
		1 1/2"	R-68	68	10	0,026
1 1/2" (5)		1" - 1 1/2"	R-75	75	10	0,030
		2 1/2"	R-90	90	12	0,030
2 1/2" (6)		1 1/2" - 2 1/2"	R-116	115	9	0,035



Två universalknutar stämmer inte med tabellen ovan. De ska ha följande O-ringar:

UK 11S - R - 19 UK 44 - R - 22



Two universal joints do not fit in the table above. They need these retaining rings:

UK 11S - R - 19 UK 44 - R - 22





Zwei Kugelgelenke passen nicht in diese Tabelle. Dafür brauchen Sie folgende O-Ringe:

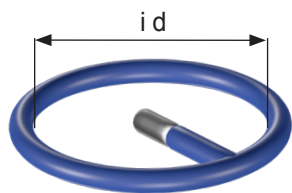

UK 11S - R - 19 UK 44 - R - 22





 Ett sätt att säkra verktyget är Ret Ring, som är pinne och ring i ett stycke.

 One way of securing the tool is Ret Ring, which combines ring and pin in one unit.

 Mit Ret Ring, eine Kombination von Stift und Ring, kann das Werkzeug gesichert werden.

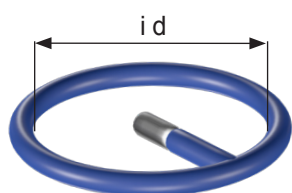
		Part No	i d mm	kg	
3/8" (1)	6-12	RR37567	17	0,001	
	13-20	RR37575	19	0,001	
	21-24	RR50095	24,1	0,001	
1/2" (4)	10-14	RR50087	22,1	0,001	
	15-30	RR50105	26,7	0,001	
	31-36	RR50145	36,8	0,001	
5/8" (8)	14-36	RR37512	30,5	0,001	
	3/4" (2)	16-65	10032S	36,8	0,001
1" (9)		19-52	10008S	44	0,005
		53-70	10015S	54	0,010
1 1/2" (5)	75-100	10019S	66,7	0,010	
	35-90	10020S	73	0,015	
	95-155	10025S	86	0,020	



		Part No	i d mm	kg
3/8" (1)	1/4" - 1/2"	RR37575	19	0,001
		RR50087	22,1	0,001
1/2" (4)	1/2" - 3/4"	RR50105	26,7	0,001
	5/8" (8)	1/2" - 3/4"	RR37512	30,5
3/4" (2)			1/2" - 1 1/2"	10032S
	1" (9)	1/2" - 1	10008S	44
1 1/4" (3)		1 3/4" - 1 1/2"	10015S	54
	3/4" - 1"	10015S	54	0,005
		1 1/2"	10019S	66,7
1 1/2" (5)	3/4" - 1 1/4"	10020S	73	0,015

 En universalknut stämmer inte med tabellen ovan. Den ska ha följande Ret Ring:

UK 44 RR 50087

 One universal joint does not fit in the table above. It needs this Ret Ring:

UK 44 RR 50087



 Ein Kugelgelenk passt nicht in diese Tabelle. Dafür brauchen Sie folgenden Ret Ring:

UK 44 RR 50087

SETS

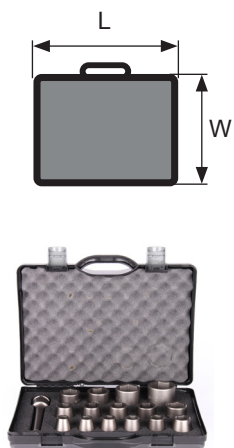



	Part No	L mm	W mm	H mm	 kg
	PSS221	385	345	95	9,50
Innehåll / Content / Inhalt					
	2-19=3/4	2-26	2-32	2-46=1 13/16	
	2-21	2-27=1 1/16	2-33	EB22-7	
	2-22	2-28	2-36		
	2-23	2-29	2-38=1 1/2		
	2-24	2-30=1 3/16	2-41		



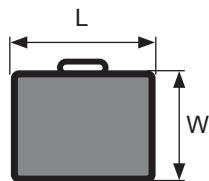

Part No

L
mmW
mmH
mm

kg

PSS441

275

225

65

2,64

Innehåll / Content / Inhalt

4-10

4-14

4-18

4-24

4-11

4-15

4-19=3/4

4-27=1 1/16

4-12

4-16

4-21

4-30=1 3/16

4-13

4-17

4-22

EB44-5

Part No

L
mmW
mmH
mm

kg

PSS441UK

275

225

65

2,64

Innehåll / Content / Inhalt

4-10

4-15

4-18

4-24

4-12

4-16

4-19=3/4

4-27=1 1/16

4-13

4-17

4-21

4-30=1 3/16

UK44

4-22

EB44-5



Part No

L
mmW
mmH
mm

kg

TPSS441

275

225

65

2,49

Innehåll / Content / Inhalt

T4-8

T4-13

T4-18

T4-23

T4-9

T4-14

T4-19=3/4

T4-24

T4-10

T4-15

T4-20

T4-27=1 1/16

T4-11

T4-16

T4-21

T4-30=1 3/16

T4-12

T4-17

T4-22

EB44-5

Part No

L
mmW
mmH
mm

kg

LPSS441

275

225

65

2,64

Innehåll / Content / Inhalt

4-10L

4-14L

4-17L

4-21L

4-13L

4-15L

4-19L

4-24L

EB44-5

Krafthylssats

Impact socket sets

Kraftsteckschlüsselsätze

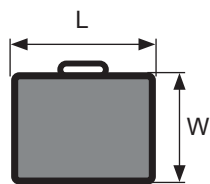

Part No

L
mmW
mmH
mm

kg

LTPSS441

275

225

65

2,64

Innehåll / Contents / Inhalt

T4-10L

T4-14L

T4-17L

T4-21L

T4-13L

T4-15L

T4-19L

T4-24L

EB44-5

Momenthylssatser

Torque socket sets

Drehmoment-Steckschlüssel-Sätze

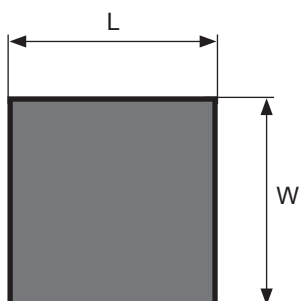

Part No

L
mmW
mmH
mm

kg

TSS44:5

280

230

40

2,02

Innehåll / Content / Inhalt

4-17-110NMC

4-19-140NMC

4-19-90NMC

4-21-110NMC

4-19-110NMC

Part No

L
mmW
mmH
mm

kg

TSS44:6

280

230

40

2,34

Innehåll / Content / Inhalt

4-17-110NMC

4-19-110NMC

4-17-120NMC

4-19-140NMC

4-19-90NMC

4-21-110NMC



Momenthylsorna är konstruerade för åtdragning av bilhjul med slående mutterdragare. Den långa och smala midjan dämpar över-skottskraften i mutterdragaren.

Det faktiska åtdragningsmomentet beror på mutterdragarens kondition och lufttrycket. Kontrollera därför regelbundet med momentnyckel.



Torque sockets are designed for tightening wheel nuts using an impact wrench. The long and narrow waistline absorbs the excess power of the impact wrench.

The actual torque depends on the condition of the impact wrench and the pneumatic equipment. Regularly check by means of a torque wrench.



Drehmoment-Steckschlüssel sind für das Festziehen von Radmutter mit Schlagschraubern konstruiert. Das dünne Mittelteil verhindert überschüssiges Drehmoment des Schlagschraubers.

Das tatsächliche Drehmoment hängt von der Leistung des Schlagschraubers ab. Regelmässige Kontrollen mit Drehmoment-Schlüsseln sind empfehlenswert.

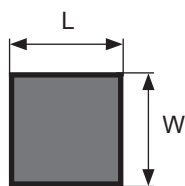

Part No

L
mmW
mmH
mm

kg

LDS:1

95

95

45

0,86

Innehåll / Contents / Inhalt

4-17LD

4-19LD

4-21LD

Part No

L
mmW
mmH
mm

kg

LDSRP:1

95

95

45

0,86

Innehåll / Contents / Inhalt

4-17LDRP

4-19LDRP

4-21LDRP





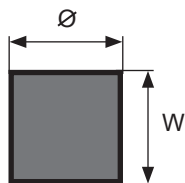

Part No	ø mm	H mm	kg
---------	------	------	----

IPAS:1	63	61	0,31
--------	----	----	------

Innehåll / Content / Inhalt

IPA14	IPA42	IPA29
-------	-------	-------

Part No	ø mm	H mm	kg
---------	------	------	----

IPAS:2	63	61	0,17
--------	----	----	------

Innehåll / Content / Inhalt

IPA01	IPA14	IPA42
-------	-------	-------

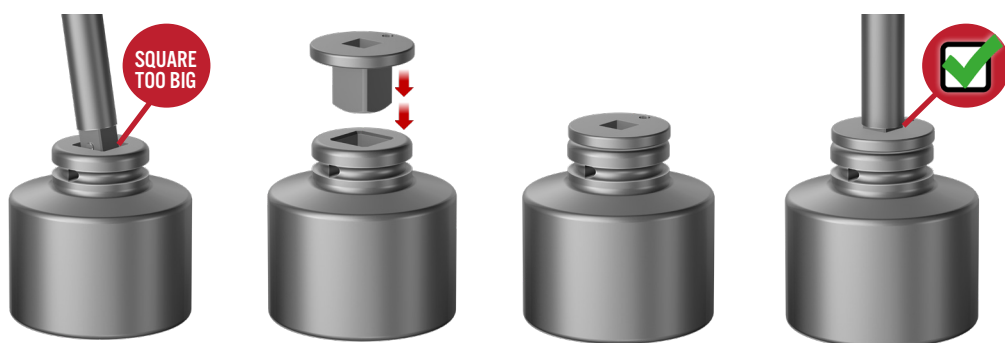



	Part No	L mm	W mm	H mm	kg
	IPSS441	95	95	45	0,86

Innehåll / Content / Inhalt			
H4-7/16	7/16-5	7/16-10	7/16-1/4
	7/16-6	7/16-12	7/16-3/8
	7/16-8	7/16-14	7/16-1/2

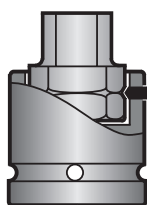

Insatsmejslarna låses med en spetsig skruv mot ett v-format spår i insatsmejselns hörn. Vid behov kan skruven säkras ytterligare med gänglåsningmedel.



The insert bit is secured by means of a pointed screw against a v-shaped groove in the corners of the insert bit. If necessary the screw can be further secured by a threadlocking material.











Die Einsatzklinge wird durch eine Spitzschraube in einer V-förmigen Nut im Eckbereich der Klinge gesichert. Wenn erforderlich, kann die Schraube mit einem Klebstoff weiter gesichert werden. Marktanforderungen jederzeit standhalten können.

MEASURE TABLES



Tum - millimeter		Inch - millimeter					Zoll - Millimeter		
"		0"	1"	2"	3"	4"	5"	6"	7"
1/32	1/10000	mm	mm	mm	mm	mm	mm	mm	mm
			25,3995	50,7990	76,1986	101,598	126,998	152,397	177,797
1/32	0,0313	0,7937	26,1932	51,5928	76,9923	102,391	127,791	153,190	178,590
1/16	0,0625	1,5874	26,9870	52,3865	77,7860	103,185	128,585	153,984	179,384
3/32	0,0938	2,3812	27,7807	53,1802	78,5798	103,979	129,378	154,788	180,177
1/8	0,125	3,1749	28,5744	53,9740	79,3735	104,773	130,172	155,572	180,971
5/32	0,1563	3,9686	29,3682	54,7677	80,1672	105,566	130,966	156,365	181,765
3/16	0,1875	4,7624	30,1619	55,5614	80,9610	106,360	131,760	157,159	182,559
7/32	0,2188	5,5561	30,9556	56,3552	81,7547	107,154	132,553	157,953	183,352
1/4	0,25	6,3498	31,7494	57,1489	82,5485	107,948	133,347	158,747	184,146
9/32	0,2813	7,1436	32,5431	57,9426	83,3422	108,741	134,141	159,540	184,940
5/16	0,3125	7,9373	33,3368	58,7364	84,1359	109,535	134,935	160,335	185,734
11/32	0,3438	8,7310	34,1306	59,5301	84,9297	110,329	135,728	161,128	186,527
3/8	0,375	9,5248	34,9243	60,3239	85,7234	111,122	136,522	161,922	187,321
13/32	0,4063	10,3185	35,7180	61,1176	86,5171	111,916	137,316	162,715	188,115
7/16	0,4375	11,1122	36,5118	61,9113	87,3109	112,710	138,109	163,509	188,909
15/32	0,4688	11,9060	37,3055	62,7051	88,1046	113,504	138,903	164,303	189,702
1/2	0,5	12,6997	38,0993	63,4988	88,8983	114,297	139,697	165,097	190,496
17/32	0,5313	13,4934	38,8930	64,2925	89,6921	115,091	140,491	165,890	191,290
9/16	0,5625	14,2872	39,6867	65,0863	90,4858	115,885	141,284	166,684	192,084
19/32	0,5938	15,0809	40,4805	65,8800	91,2795	116,679	142,078	167,478	192,877
5/8	0,625	15,8747	41,2742	66,6737	92,0733	117,472	142,872	168,271	193,671
21/32	0,6563	16,6684	42,0679	67,4675	92,8670	118,266	143,666	169,065	194,465
11/16	0,6875	17,4621	42,8617	68,2612	93,6608	119,060	144,459	169,859	195,258
23/32	0,7188	18,2559	43,6554	69,0549	94,4545	119,854	145,253	170,653	196,052
3/4	0,75	19,0496	44,4491	69,8487	95,2482	120,647	146,047	171,446	196,846
25/32	0,7813	19,8433	45,2429	70,6424	96,0419	121,441	146,841	172,240	197,640
13/16	0,8125	20,6371	46,0366	71,4362	96,8357	122,235	147,634	173,034	198,433
27/32	0,8438	21,4308	46,8303	72,2299	97,6294	123,029	148,428	173,828	199,227
7/8	0,875	22,2245	47,6241	73,0236	98,4232	123,822	149,222	174,621	200,021
29/32	0,9063	23,0183	48,4178	73,8173	99,2169	124,616	150,016	175,415	200,815
15/16	0,9375	23,8120	49,2116	74,6111	100,011	125,410	150,809	176,209	201,608
31/32	0,9688	24,6057	50,0053	75,4048	100,804	126,203	151,603	177,003	202,402



Gänga - nyckelvidd				Impact socket sets		Kraftsteckschlüsselsätze		
	 mm		 mm		 UNC	 "	 SAE	 "
M 2	4	M 27	41		1/4	7/16	1/4	7/16
M 2.3	4.5	M 30	46		5/16	1/2	5/16	1/2
M 2.6	5	M 33	50		3/8	9/16	3/8	9/16
M 3	5.5	M 36	55		7/16	11/16	7/16	5/8
M 3.5	6	M 39	60		1/2	3/4	1/2	3/4
M 4	7	M 42	65		9/16	7/8	9/16	7/8
M 5	8	M 45	70		5/8	15/16	5/8	15/16
(M 5-6)	9	M 48	75		3/4	1 1/8	3/4	1 1/16
M 6	10	M 52	80		7/8	1 5/16	7/8	1 1/4
M 7	11	M 56	85		1	1 1/2	1 1/8	1 7/16
M 8	13	M 60	90		1 1/8	1 11/16	1 1/4	1 13/16
(M 8)	14	M 64	95		1 1/4	1 7/8	1 3/8	2
M 10	16	M 68	100		1 3/8	2 1/16	1 1/2	2 3/16
(M 10)	17	M 72	105		1 1/2	2 1/4		
M 12	18	M 76	110		1 3/4	2 5/8		
(M 12)	19	M 80	115		2	3		
M 14	21	M 85	120		2 1/4	3 3/8		
(M 14)	22	M 90	130		2 1/2	3 3/4		
M 16	24	M 95	135					
M 18	27	M 100	145					
M 20	30	M 105	150					
(M 22)	32	M 110	155					
M 22	34	M 115	165					
M 24	36	M 120	170					





Foot-Pound - Newton-Meter

lbf-ft	0	1	2	3	4	5	6	7	8	9
0		1.4	2.7	4.1	5.4	6.8	8.1	9.5	10.9	12.2
10	13.6	14.9	16.3	17.6	19.0	20.3	21.7	23.1	24.4	25.8
20	27.1	28.5	29.8	31.2	32.5	33.9	35.3	36.6	38.0	39.3
30	40.7	42.0	43.4	44.8	46.1	47.5	48.8	50.2	51.5	52.9
40	54.2	55.6	57.0	58.3	59.7	61.0	62.4	63.7	65.1	66.4
50	67.8	69.2	70.5	71.9	73.2	74.6	75.9	77.3	78.7	80.0
60	81.4	82.7	84.1	85.4	86.8	88.1	89.5	90.9	92.6	93.6
70	94.9	96.3	97.6	99.0	100.3	101.7	103.1	104.4	105.8	107.1
80	108.5	109.8	111.2	112.6	113.9	115.3	116.6	118.0	119.3	120.7
90	122.0	123.4	124.8	126.1	127.5	128.8	130.2	131.5	132.9	134.2
100	135.6	137.0	138.3	139.7	141.0	142.4	143.7	145.1	146.5	147.8

Newton-Meter - Foot-Pound

Nm	0	1	2	3	4	5	6	7	8	9
0		0.7	1.5	2.2	3.0	3.7	4.4	5.2	5.9	6.6
10	7.4	8.1	8.9	9.6	10.3	11.1	11.8	12.5	13.3	14.0
20	14.8	15.5	16.2	17.0	17.7	18.5	19.2	19.9	20.7	21.4
30	22.1	22.9	23.6	24.4	25.1	25.8	26.6	27.3	28.0	28.8
40	29.5	30.3	31.0	31.7	32.5	33.2	34.0	34.7	35.4	36.2
50	36.9	37.6	38.4	39.1	39.9	40.6	41.3	42.1	42.8	43.5
60	44.3	45.0	45.8	46.5	47.2	48.0	48.7	49.5	50.2	50.9
70	51.7	52.4	53.1	53.9	54.6	55.4	56.3	56.8	57.6	58.3
80	59.0	59.8	60.5	61.2	62.0	62.7	63.5	64.2	64.9	65.7
90	66.4	67.2	67.9	68.6	69.4	71.1	70.9	71.6	72.3	73.1
100	73.8	74.5	75.3	76.0	76.8	77.5	78.2	79.0	79.7	80.4

Kilopond-Meter - Newton-Meter

kpm	0	1	2	3	4	5	6	7	8	9
0		9.8	19.6	29.4	39.2	49.0	58.8	68.7	78.5	88.3
10	98.1	107.9	117.7	127.5	137.3	147.1	156.9	166.7	176.5	186.3
20	196.1	205.9	215.8	225.6	235.4	245.2	255.0	264.8	274.6	284.4
30	294.2	304.0	313.8	323.6	333.4	343.2	353.0	362.9	372.7	382.5
40	392.3	402.1	411.9	421.7	431.5	441.3	451.1	460.9	470.7	480.5
50	490.3	500.1	510.0	519.8	529.6	539.4	549.2	559.0	568.8	578.6
60	588.4	598.2	608.0	617.8	627.6	637.4	647.2	657.0	666.9	676.7
70	686.5	696.3	706.1	715.9	725.7	735.5	745.3	755.1	764.9	774.7
80	784.5	794.3	804.1	814.0	823.8	833.6	843.4	853.2	863.0	872.8
90	882.6	892.4	902.2	912.0	921.8	931.6	941.4	951.2	961.1	970.9
100	980.7	990.5	1 000.3	1 010.1	1 019.9	1 029.7	1 039.5	1 049.3	1 059.1	1 068.9

WARRANTY





GARANTI

Varje verktyg från Momento är konstruerat och testat för att överträffa kraven i dess avsedda användning.

Om något Momento verktyg fallerar på grund av fel i material eller utförande, kontakta din Momento återförsäljare så blir verktyget utbytt.

Vid garantianspråk ska blanketten "Reklamationsrapport" användas, blanketten hittar ni på vår hemsida. Returnera inga produkter utan förgående tillstånd från Momento. Om inget annat anges i anbud eller godkänns skriftligt av Momento, så gäller att Momento verktyg är garanterade så länge de ägs av den första användande köparen. Denna garanti omfattar inte sådana fel som inte härrör sig till defekter i material eller utförande, däribland fel orsakade av olyckor, otillräckligt underhåll, missbruk, otillåtna ändringar eller reparationer, felaktig förvaring och normalt slitage.

WARRANTY

Each Momento tool is built to more than meet the requirements of its intended use. Any Momento tool which fails because of defective material or workmanship will be replaced through your Momento dealer. In the case of warranty claims, the form "Warranty claim report" shall be used, you find it on the Momento website. No Products shall be returned without prior authorization from Momento. Unless otherwise set forth in a quotation or agreed to by Momento in writing, Momento tools are warranted for as long as they are owned by the first using purchaser.

This warranty does not cover any failures which are not attributable to defects in materials or workmanship, including without limitation, failures caused by accidents, inadequate maintenance, misuse, unauthorized modifications or repairs, improper storage, and normal wear and tear.

GARANTIE

Jedes Momento Werkzeug ist für Höchstleistungen konstruiert. Momento ersetzt über ihre Händler jedes fehlerhafte Momento Produkt kostenlos (nur für Material- oder Verarbeitungsfehler). Bei Garantieansprüchen ist das Formular "Warranty claim report" zu verwenden, das Sie auf unserer Webseite finden. Senden Sie keine Produkte ohne vorherige Genehmigung von Momento zurück. Sofern nicht anders in einem Angebot angegeben oder von Momento schriftlich zugesagt, gilt für Standard-Produkte eine Garantie, solange sie sich in Besitz des Erstkäufers befinden.

Diese Garantie gilt nicht für Fehler, die keine Material- oder Fertigungsfehler sind, einschließlich ohne Einschränkung Fehler, die durch Unfälle, nicht angemessene Wartung, falsche Verwendung, nicht genehmigte Modifizierungen oder Reparaturen, falsche Aufbewahrung und normalen Verschleiß verursacht werden.



AB Momento: med reservation för ändringar och ev. tryckfel. Gäller för hela katalogen.

AB Momento: with reservation for changes and any misprints. Applies to the entire catalog.

AB Momento: unter Vorbehalt von Änderungen und Druckfehlern. Gilt für den gesamten Katalog.



© momento®

© momento®

© momento®

R144 75165

R133 46136

Made in Sweden

Made in Sweden

Made in Sweden



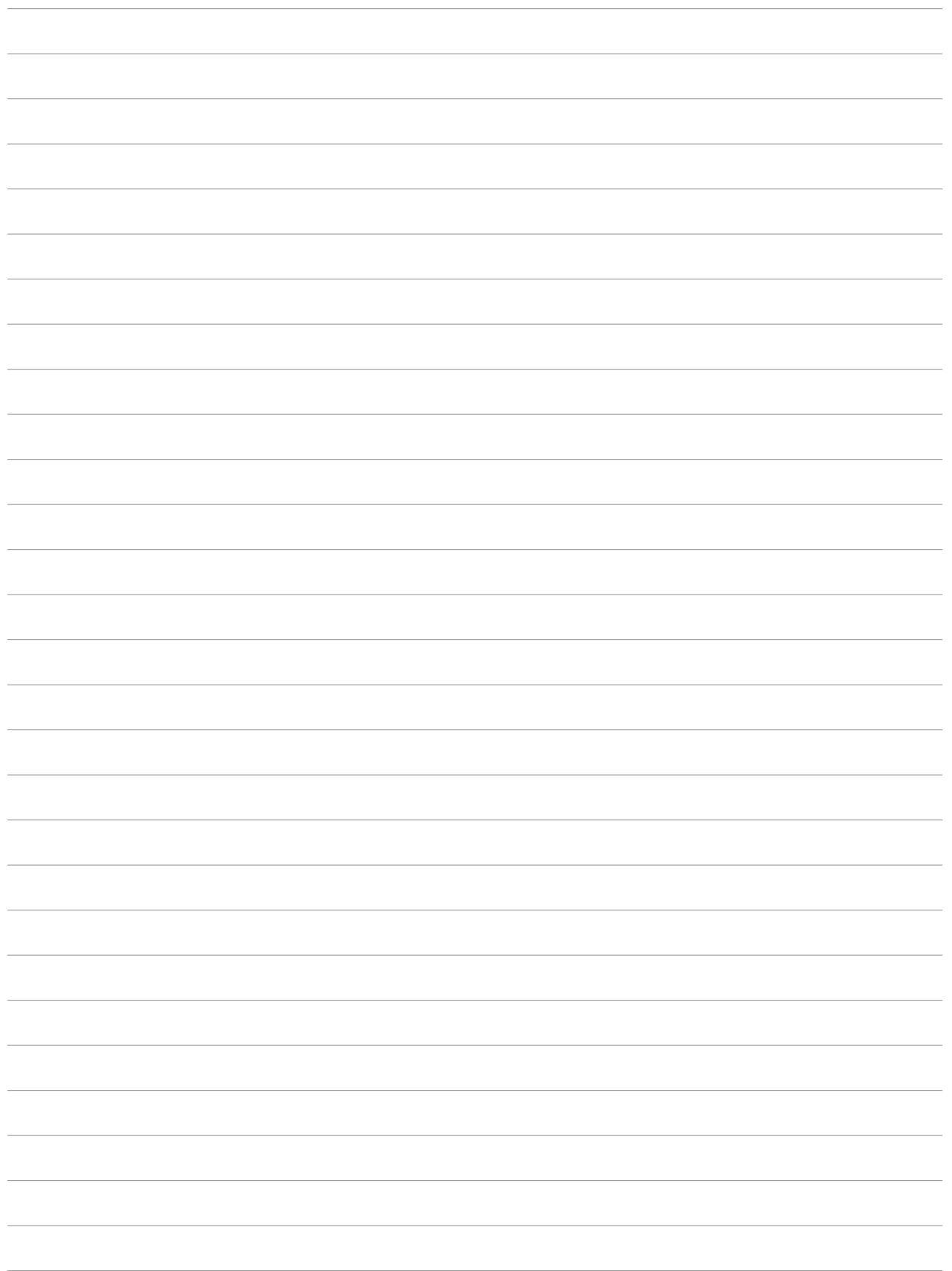

We have
WORLDWIDE DISTRIBUTION

www.momento.se



MOMENTO
P.O. Box 14
642 21 Flen
Sweden

VISITING ADDRESS
Kungsvägen 68
642 34 Flen
Sweden

CONTACT US
+46 157-690 00
info@momento.se
www.momento.se

